















7		6		5		4		3		2		1	
SOLID CONTACT PART NUMBER	SIZE TYPE	WIRE SIZE AWG [mm ²]	REF. ONLY CRIMP TENSILE LBS [N]	RECOMMENDED STRIP LENGTH INCH [mm]	CONTACT IDENTIFICATION INFO & NOTES		REV	HDT-48-00		REVISIONS			
							M2	SYM	DESCRIPTION	DATE	APPROVED		
0460-204-12** 0460-211-12** 0460-220-12** 0460-235-12** 0460-258-12** 0462-203-12** 0462-210-12** 0462-214-12** 0462-215-12**	12 PIN 12 PIN 12 PIN 12 PIN 12 PIN 12 SOC 12 SOC 12 SOC 12 SOC	12 AWG 3.0 mm ² 2.5 mm ² 14 AWG 2.0 mm ²	75 [334]	.222-.284 [5.64-7.21]	0462-215-12** MARKING 1 GRAY BAND, NARROW 1 BROWN BAND, NARROW 1 BROWN BAND, BROAD		M2	M2	ECR-17-018412	12/2017	CM		
0460-256-12**	12 PIN	1.5 mm ² 16 AWG 1.0 mm ² 18 AWG 0.75 mm ²	35 [156]	.222-.284 [5.64-7.21]									
0460-215-16** 0462-209-16**	16 PIN 16 SOC	14 AWG 2.0 mm ²	70 [311]	.250-.312 [6.35-7.92]	1 GREEN BAND, BROAD 1 GREEN BAND, BROAD								
0460-002-16** 0460-202-16** 0460-211-16** 0460-230-16** 0460-235-16** 0460-247-16** 2325529-1 0462-004-16** 0462-007-16** 0462-201-16** 0462-214-16** 0462-221-16** 0462-222-16** 2325584-1	16 PIN 16 PIN 16 PIN 16 PIN 16 PIN 16 PIN 16 PIN 16 SOC 16 SOC 16 SOC 16 SOC 16 SOC 16 SOC 16 SOC	1.5 mm ² 16 AWG 1.0 mm ² 18 AWG 0.75 mm ² 20 AWG 0.50 mm ²	35 [156]	.250-.312 [6.35-7.92]	2325529-1 MARKING 3 BROWN BANDS 2325584-1 MARKING 2 BROWN BANDS 1 BLUE BAND 0460-002-1631 AND 0462-004-1631 MARKING 1 BLUE BAND, BROAD								
0462-001-16**	16 SOC	16 AWG 1.0 mm ²	35 [156]	.250-.312 [6.35-7.92]	1 BLUE BAND, NARROW								
0462-223-16**	16 SOC	1.5 mm ² 16 AWG 1.0 mm ²	35 [156]	.117-.237 [4.49-6.02]	USE 2.0 mm ² DIAL SET								
0460-010-20** 0462-005-20**	20 PIN 20 SOC	16 AWG 1.00 mm ² 18 AWG 0.75 mm ²	20 [89]	.156-.218 [3.96-5.54]	1 PURPLE BAND, BROAD								
2325531-1 0460-202-20** 0462-201-20** 2325530-1	20 PIN 20 PIN 20 SOC 20 SOC	20 AWG 0.50 mm ² 22 AWG 0.35 mm ²	20 [89] 10 [44]	.156-.218 [3.96-5.54]	2325531-1 MARKING 2 BROWN BANDS 1 BLACK BAND 2325530-1 MARKING 2 BROWN BANDS 1 GREEN BAND								
112349 112352	12 PIN 12 SOC	12 AWG 3.0 mm ² 2.5 mm ² 14 AWG 2.0 mm ²	75 [334] 70 [311]	.222-.284 [5.64-7.21]	SLOTTED (SPLIT) PIN  								
0460-201-1690 0461-201-1690	16 PIN 16 SOC	1.5 mm ² 16 AWG 1.0 mm ² 18 AWG 0.75 mm ²	35 [156] 25 [111]	.222-.284 [5.64-7.21]	SLOTTED (SPLIT) PIN								
8960-025-12603 8962-014-12603	12 PIN 12 SOC	4.0 mm ² 12 AWG 3.0 mm ² 2.5 mm ²	75 [334]	.222-.284 [5.64-7.21]									
8960-020-16603 8962-011-16603	16 PIN 16 SOC	1.5 mm ² 16 AWG 1.0 mm ² 18 AWG 0.75 mm ² 20 AWG 0.50 mm ²	35 [156] 25 [111] 20 [89]	.250-.312 [6.35-7.92]									
 DEPTH ADJUSTING SCREW P/N 0426-209-0000 INCLUDES JAM NUT.  USE 2.5/14 SETTING FOR THIS PART WITH 12 AWG.  USE 1.5 SETTING FOR THIS PART WITH 14 AWG.  CAUTION: NEVER CLOSE TOOL ON GAGE G454. CLOSE TOOL FIRST AND THEN INSERT GAGE.  USE  IN DIAL POSITION  TO CHECK WEAR ANNUALLY. CHECK OFTEN IF USED FOR FREQUENT CRIMPING.													
NOTES: UNLESS OTHERWISE SPECIFIED													

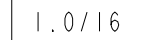
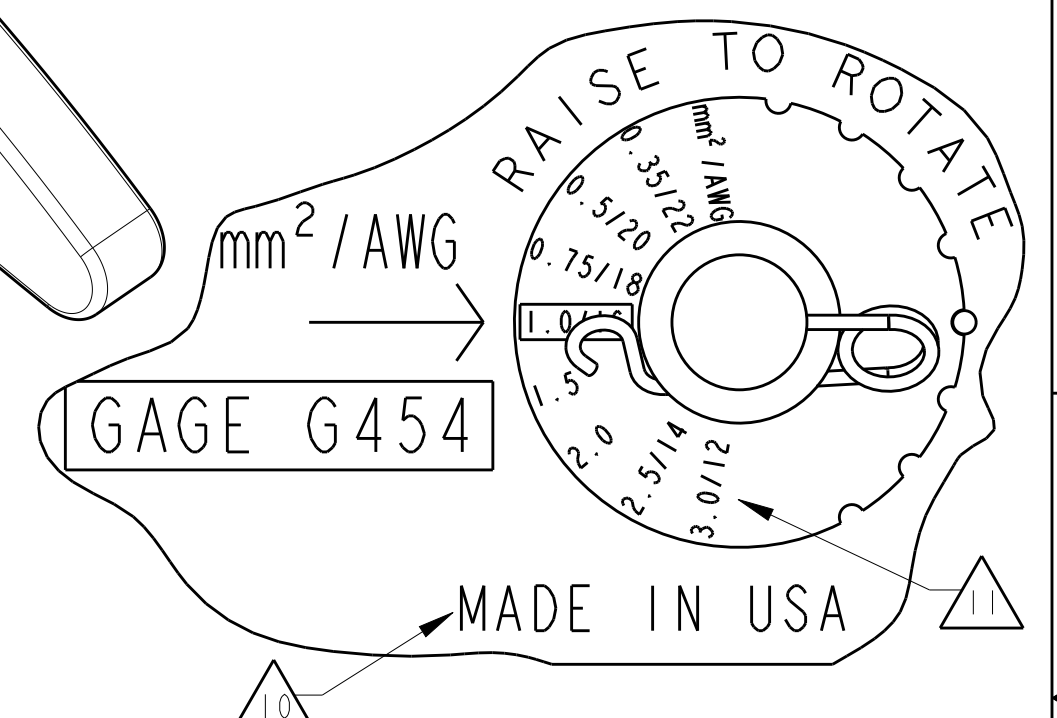
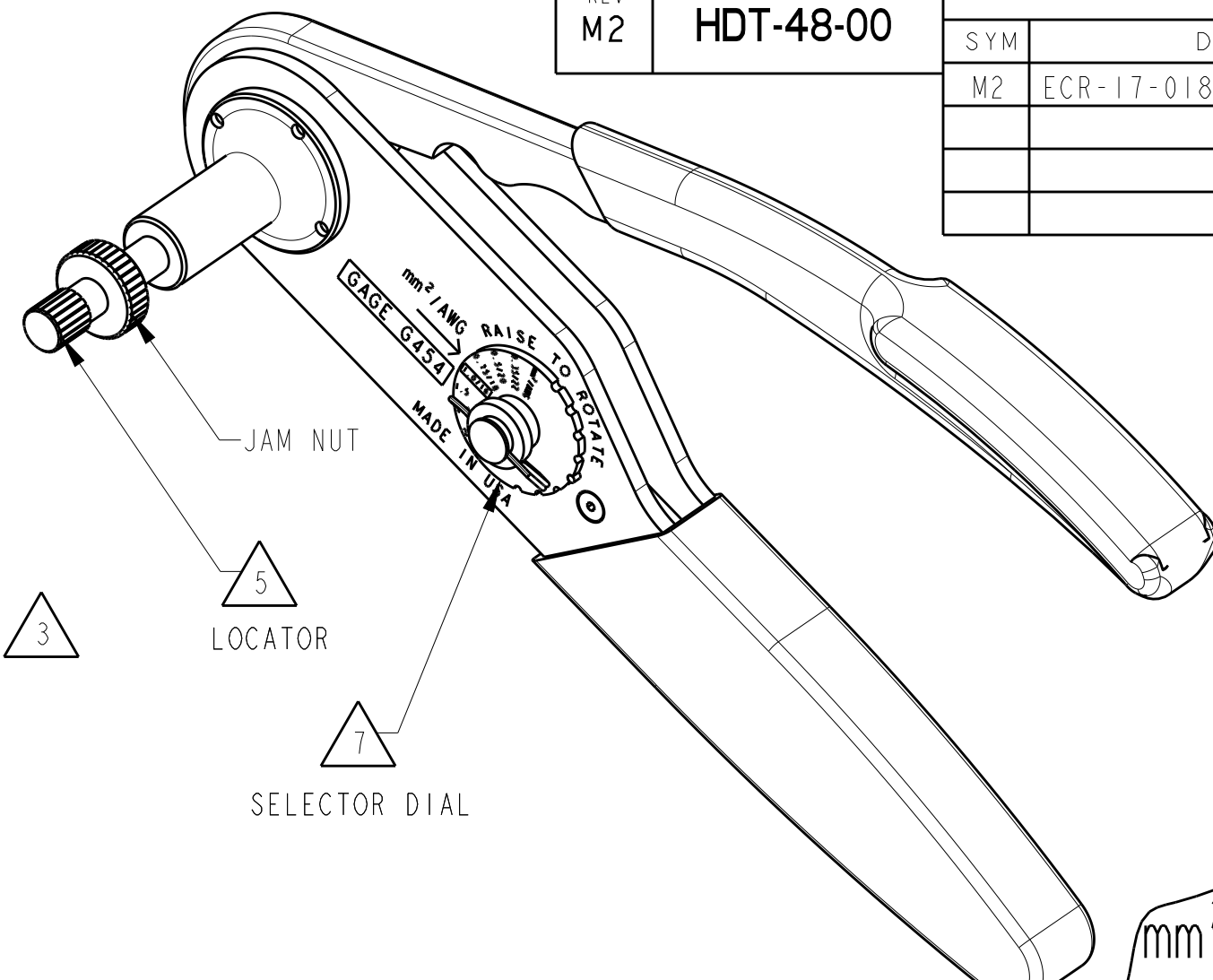

SOLID CONTACT PART NUMBER	SIZE TYPE	WIRE SIZE AWG [mm ²]	REF. ONLY CRIMP TENSILE LBS [N]	RECOMMENDED STRIP LENGTH INCH [mm]	CONTACT IDENTIFICATION INFO & NOTES
4060-002-12** 4062-002-12**	12 PIN 12 SOC	12 AWG 3.0 mm ² 2.5 mm ² 14 AWG 2.0 mm ²	75 [334] 70 [311]	.250-.312 [6.35-7.92]	 
4060-001-16** 4062-001-16**	16 PIN 16 SOC	1.5 mm ² 16 AWG 1.0 mm ² 18 AWG 0.75 mm ²	35 [156] 25 [111]	.240-.302 [6.10-7.67]	

-  USE 3.0/12 SETTING FOR THIS PART WITH 4.0mm².
-  COUNTRY OF ORIGIN "MADE IN USA" SHOWN AS EXAMPLE.
- 9. SEE 0425-071-0000 INSTRUCTION GUIDE, SHIPPED WITH TOOL.
- 8. OVERALL TOOL LENGTH IS APPROXIMATELY 9.90 [251.46].
-  CYCLE TOOL TO OPEN HANDLES. REMOVE LOCK CLIP. RAISE AND ROTATE DIAL TO SELECT WIRE SIZE. REPLACE LOCK CLIP.
-  WHEN **= 31, PLATING IS GOLD.
WHEN **=141, PLATING IS NICKEL.

SIGNATURE & DATE		TOOL, HAND CRIMP FOR SIZE 20, 16 & 12 SOLID CONTACTS	EP	MATL. CODE
DR	J. APOSTOL 21FEB2007		3850 INDUSTRIAL AVE. HEMET, CA 92545	
CHK		ENVELOPE	DEUTSCH INDUSTRIAL	
PE			C HDT-48-00	
APPD		DWG SIZE	CODE 4AFUB	SHEET OF
SCALE NONE	WT			