

THIS DRAWING IS UNPUBLISHED. RELEASED FOR PUBLICATION XXXXX2011  
 © COPYRIGHT 2014 BY Tyco Electronics Japan G.K. ALL RIGHTS RESERVED.

LOC	DIST	REVISIONS			
P	LTR	DESCRIPTION	DATE	DWN	APVD
	B	REVISED	12JUN2018	K.T	E.I
	C	REVISED	04SEP2020	R.I	E.I
	D	REVISED	27JULY2023	H.O	T.S

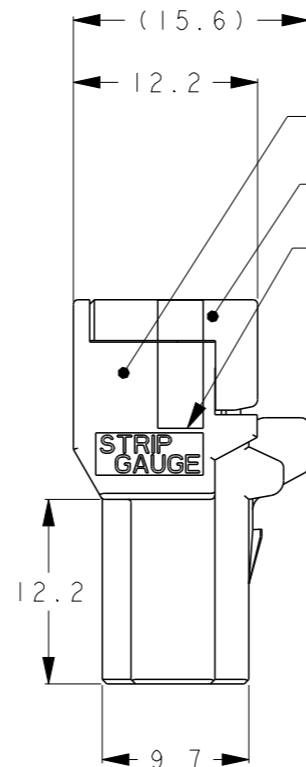

HOUSING COLOR: BLACK  
 HOUSING COLOR: BLACK  
 STRIP GAUGE

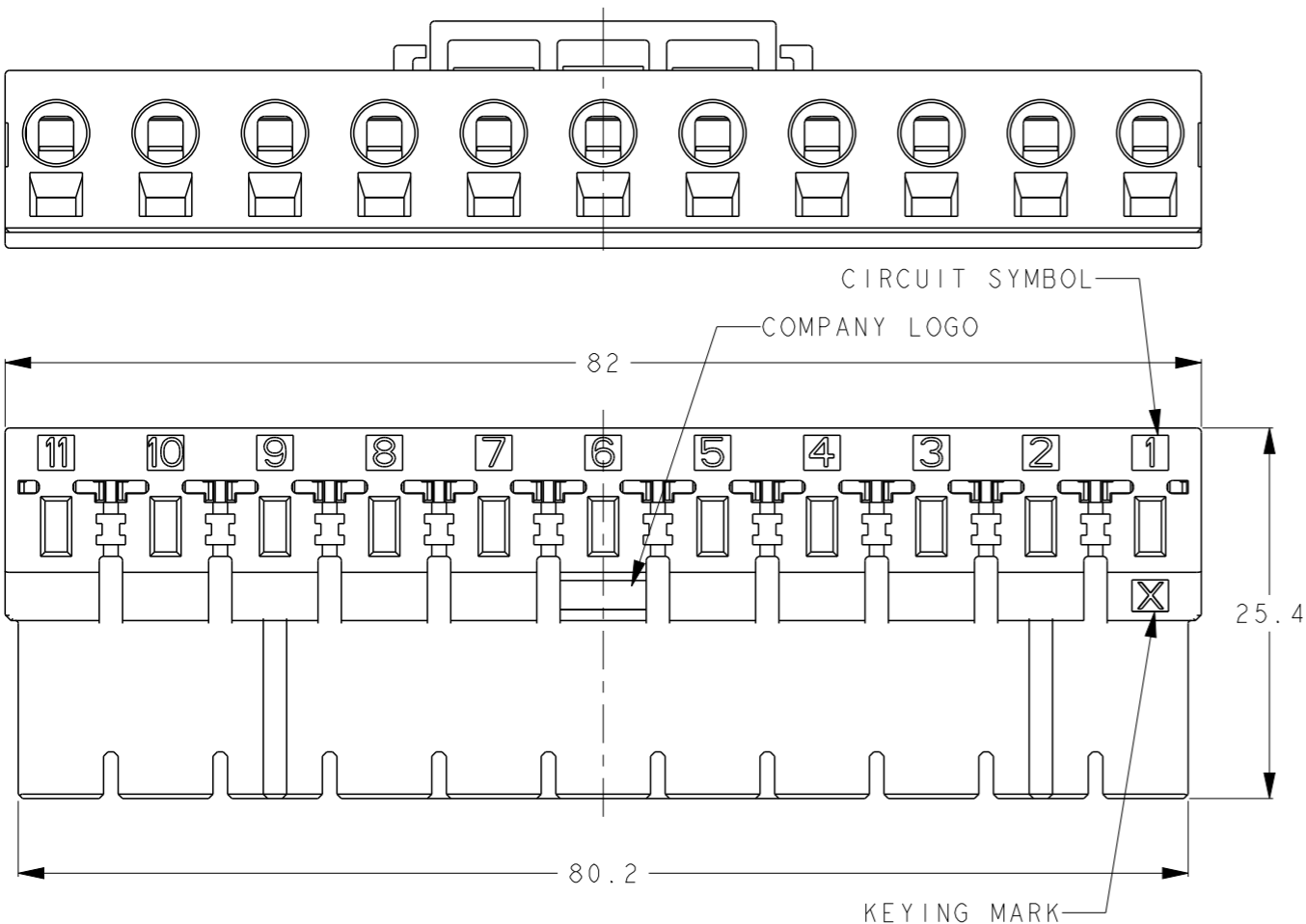
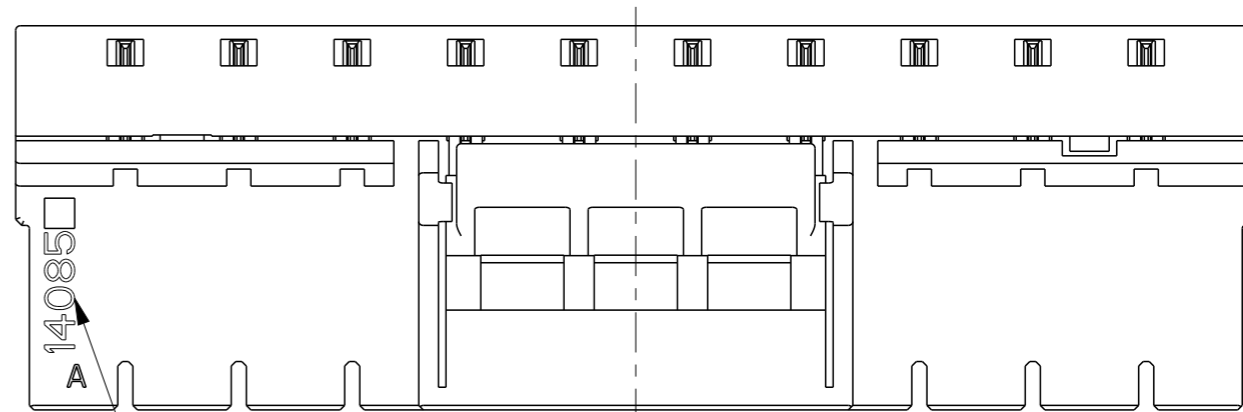

DATE CODE (FIRST 5 DIGITS)  
 ASSEMBLY MACHINE ID (THE REST)

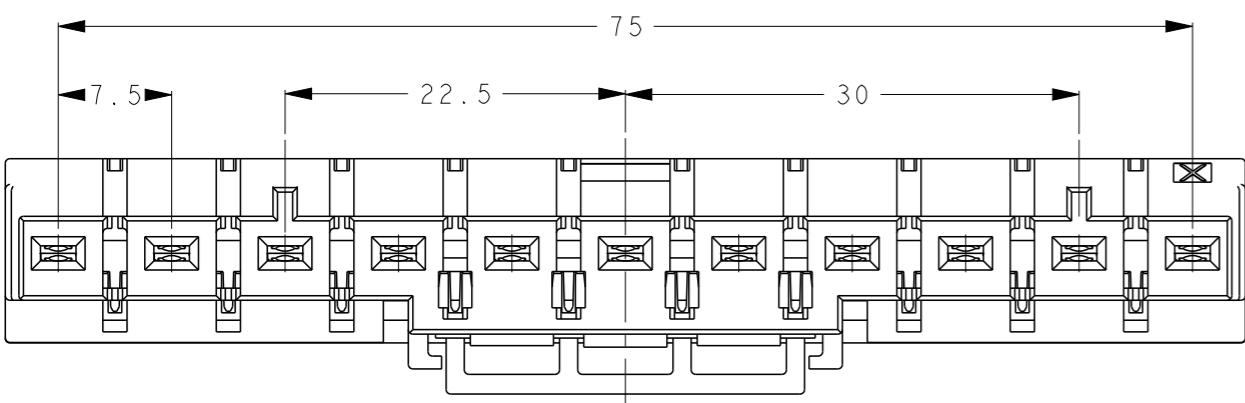

- 1 MATERIAL  
 HOUSING: THERMO PLASTICS  
 CONTAMINATION Ø1.2 MAX  
 CONTACT: COPPER ALLOY  
 SPRING: STAINLESS
- 2 PLATING  
 CONTACT POINT: UNDER Ni PLATING, OVER Au PLATING.  
 WIRE CLAMPING POINT: UNDER Ni PLATING, OVER Tin PLATING.

1-2289080-1 (I POSITION KEYING: X)

X	II	1-2289080-1
KEYING	POS	PART NUMBER

THIS DRAWING IS A CONTROLLED DOCUMENT.		DWN K. TERAJIMA 24AUG2016	 TE Connectivity				
DIMENSIONS: mm		CHK E. TAKEMASA 24AUG2016					
TOLERANCES UNLESS OTHERWISE SPECIFIED: ±0.3		APVD E. TAKEMASA 24AUG2016	NAME RECEPTACLE ASSEMBLY DYNAMIC D3950				
0 PLC ± 1 PLC ± 2 PLC ± 3 PLC ± 4 PLC ± ANGLES ±5° FINISH SEE NOTE		PRODUCT SPEC 108-78997	SIZE A3	CAGE CODE 00779	DRAWING NO C-2289080	RESTRICTED TO -	
MATERIAL SEE NOTE		APPLICATION SPEC 411-78272	SCALE 2:1		SHEET 1	OF 3	REV D
		WEIGHT -	CUSTOMER DRAWING				

THIS DRAWING IS UNPUBLISHED. RELEASED FOR PUBLICATION XXXX2011  
 © COPYRIGHT 2014 BY Tyco Electronics Japan G.K. ALL RIGHTS RESERVED.

LOC J DIST -

REVISIONS					
P	LTR	DESCRIPTION	DATE	DWN	APVD
	-	SEE SHEET 1	-	-	-

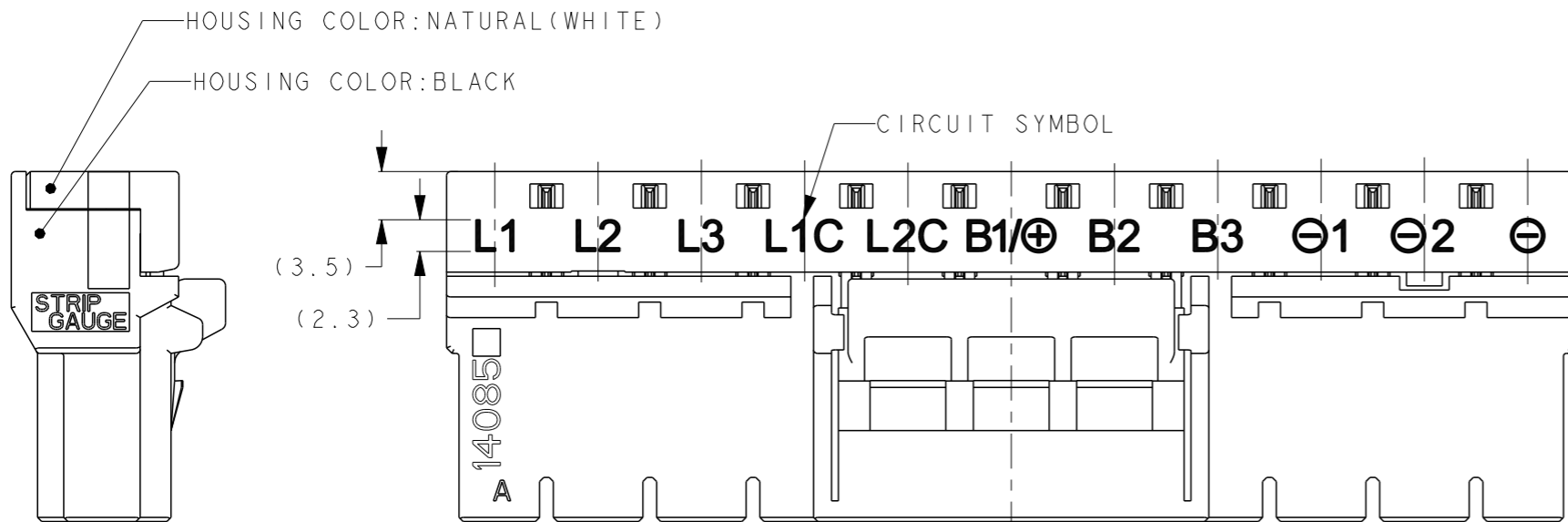

I-2289080-2 (11 POSITION KEYING: X)

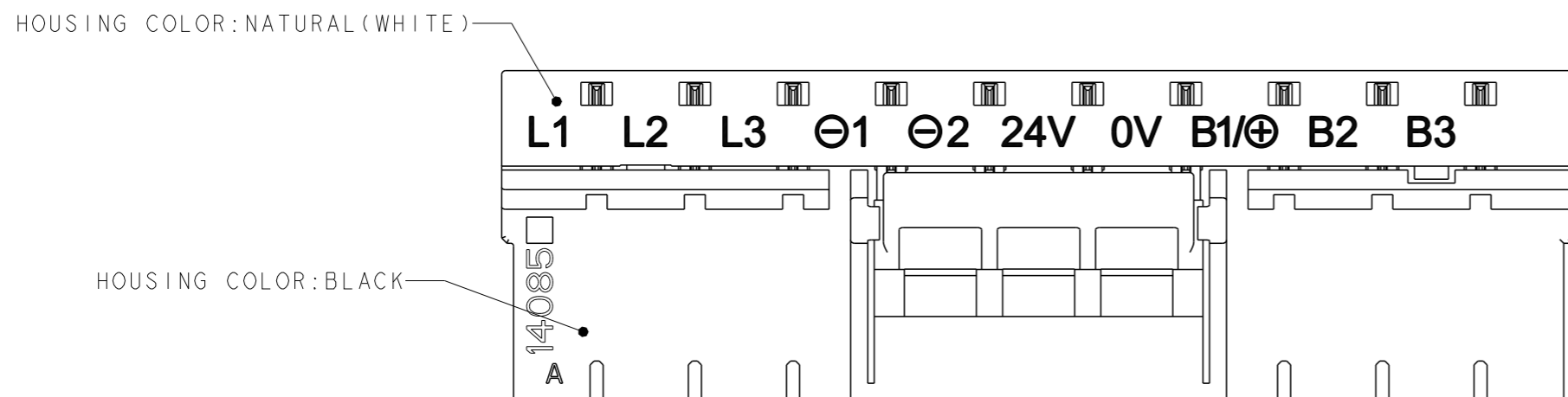

I-2289080-3 (10 POSITION KEYING: Y)

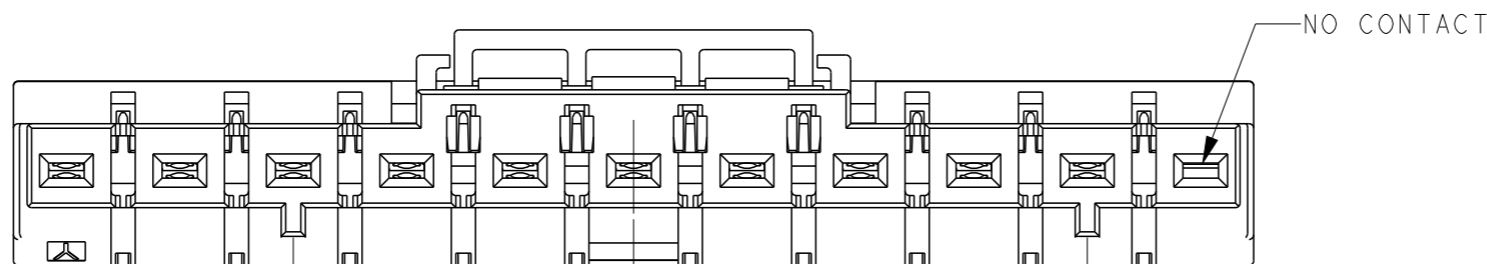

Y	10	I-2289080-3
X	11	I-2289080-2
KEYING	POS	PART NUMBER

THIS DRAWING IS A CONTROLLED DOCUMENT.

DIMENSIONS: mm	TOLERANCES UNLESS OTHERWISE SPECIFIED: ± 0.3
	0-PLC ±
	1-PLC ±
	2-PLC ±
	3-PLC ±
	4-PLC ±
	ANGLES ±5°
MATERIAL SEE NOTE	FINISH SEE NOTE

DWN	24AUG2016
K. TERAJIMA	
CHK	24AUG2016
E. TAKEMASA	
APVD	24AUG2016
E. TAKEMASA	
PRODUCT SPEC	108-78997
APPLICATION SPEC	411-78272
WEIGHT	-

<b>STE</b> TE Connectivity			
NAME RECEPTACLE ASSEMBLY DYNAMIC D3950			
SIZE	CAGE CODE	DRAWING NO	RESTRICTED TO
A3	00779	C-2289080	-

CUSTOMER DRAWING SCALE 2:1 SHEET 2 OF 3 REV D

THIS DRAWING IS UNPUBLISHED.

RELEASED FOR PUBLICATION

XXXXX2011

© COPYRIGHT 2014

BY Tyco Electronics Japan G.K.

ALL RIGHTS RESERVED.

LOC  
J

DIST  
-

REVISIONS

P	LTR	DESCRIPTION	DATE	DWN	APVD
	-	SEE SHEET 1	-	-	-

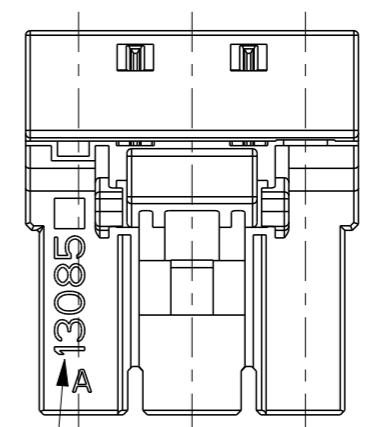
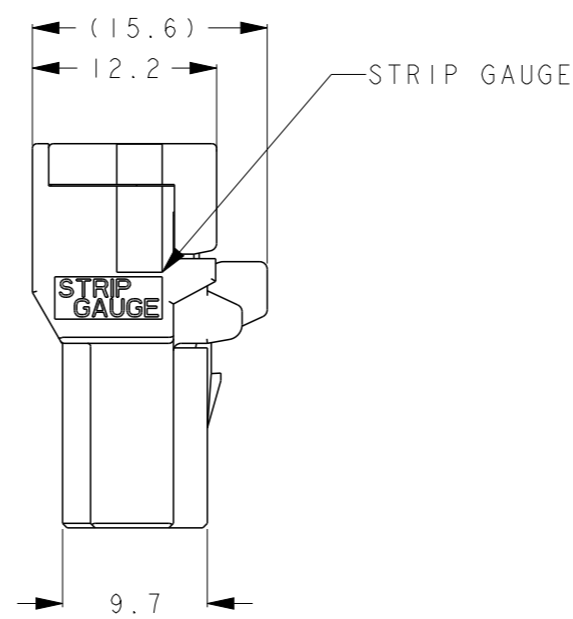
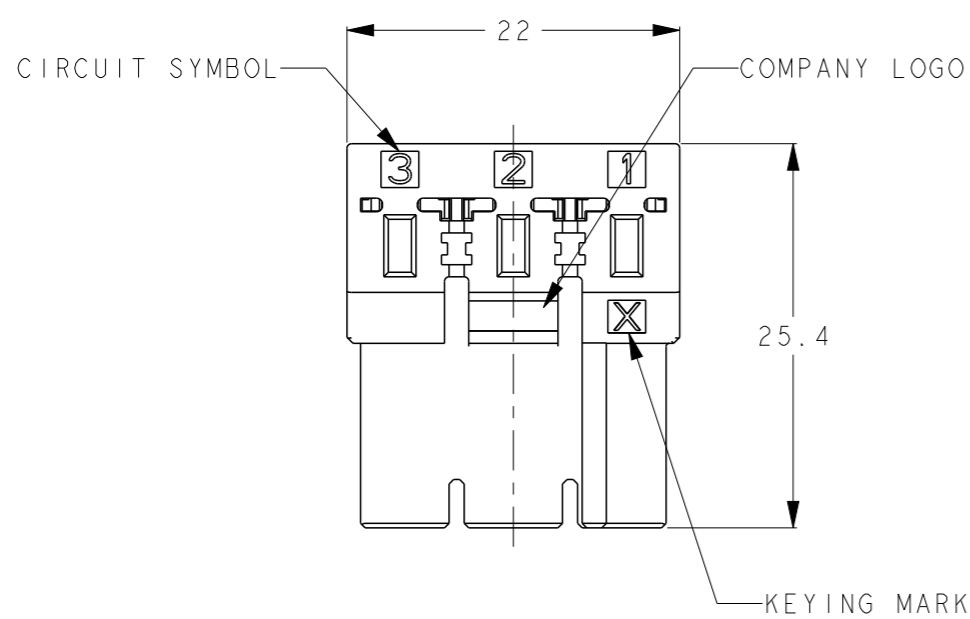
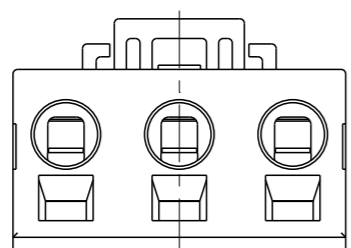

DATE CODE (FIRST 5 DIGITS)  
ASSEMBLY MACHINE ID (THE REST)

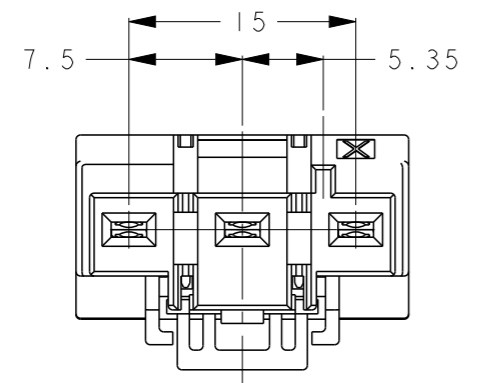

3-2289080-1 (3 POSITION KEY-X)  
COLOR: BLACK

X	3	3-2289080-1
KEYING	POS	PART NUMBER

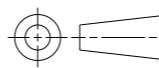
THIS DRAWING IS A CONTROLLED DOCUMENT.		DWN K. TERAJIMA 24AUG2016	 TE Connectivity		
DIMENSIONS: mm		CHK E. TAKEMASA 24AUG2016			NAME RECEPTACLE ASSEMBLY DYNAMIC D3950
		APVD E. TAKEMASA 24AUG2016			
TOLERANCES UNLESS OTHERWISE SPECIFIED: ± 0.3		PRODUCT SPEC 108-78997	SIZE A300779	CAGE CODE C-2289080	
0 PLC ± 1 PLC ± 2 PLC ± 3 PLC ± 4 PLC ± ANGLES ±5°		APPLICATION SPEC 411-78272	DRAWING NO	RESTRICTED TO	
MATERIAL SEE NOTE		FINISH SEE NOTE	WEIGHT -	SCALE 2:1	
		CUSTOMER DRAWING	SHEET 3	OF 3	
			REV D		