

THIS DRAWING IS UNPUBLISHED.

RELEASED FOR PUBLICATION

20

LOC

DIST

REVISIONS

© COPYRIGHT 20

ALL RIGHTS RESERVED.

DS

-

P	LTR	DESCRIPTION	DATE	DWN	APVD
A1		REVISED (ECR-19-009214)	12.JUN.'19	TY	YJ
A2		REVISED (ECR-22-127783)	27.JAN.'22	SJ	YJ

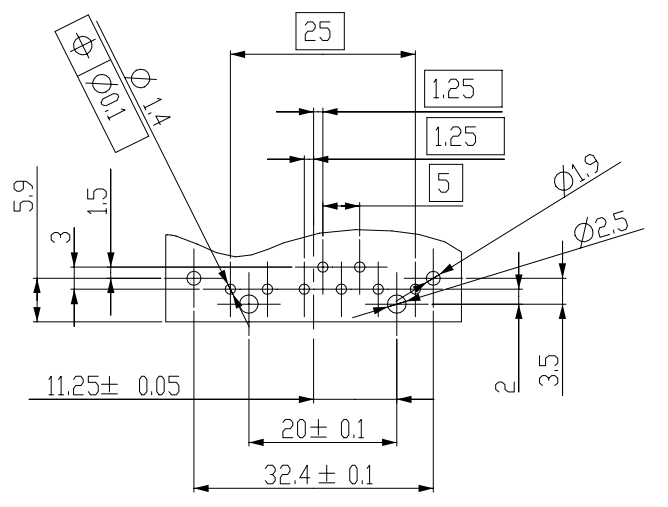

MOUNTING DIMENSION FOR P.C.B.

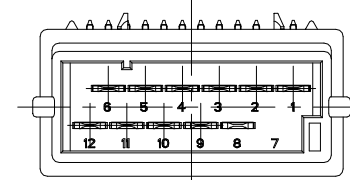
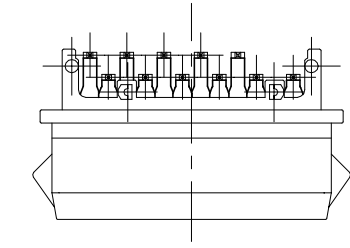
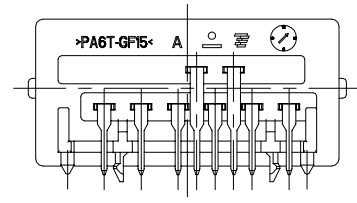

11P HEADER ASS'Y FOR SVW 2-2005351-2

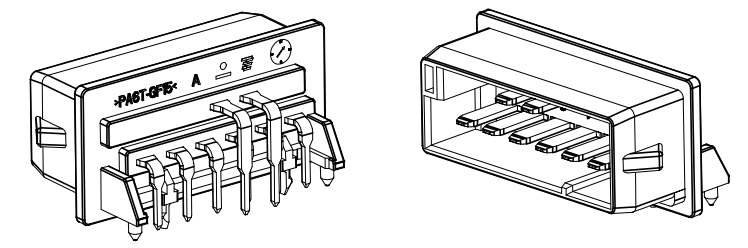
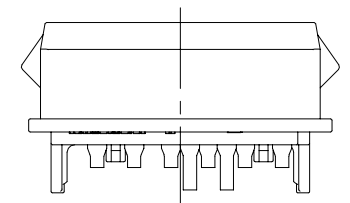
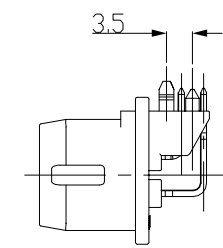
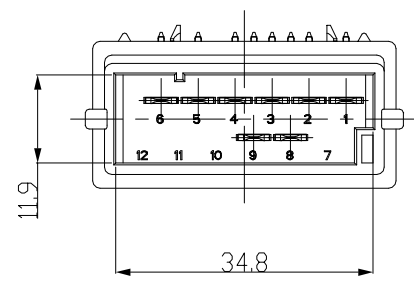
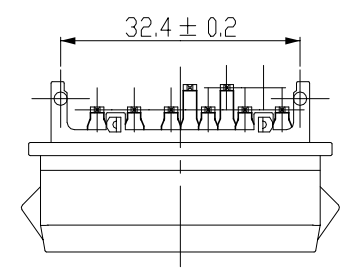

D

D

C

C

B

B

A

A

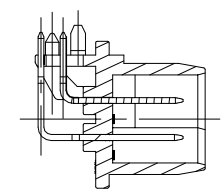

SECTION A-A

NOTE
 1. UNLESS OTHERWISE SPECIFIED, TOLERANCE ARE
 Over 0, Up to 5.0 : ±0.2
 Over 5.0 : ±0.3
 Angle : ±3°
 2. APPLICABLE P.C.B. THICKNESS : 1.6mm

NO.	COLOR	MATERIAL	DESCRIPTION	QT'Y	NAME
4	TIN PLATE	BRASS	110 TAB TERMINAL(SHORT)	6	110 8P HEADER ASS'Y FOR EPSILON
3	TIN PLATE	BRASS	110 TAB TERMINAL(LONG)	2	110 11P HEADER ASS'Y FOR SVW
2	BLACK	PA6T-GF15	110 11P HEADER HSG FOR SVW	-	1-2005351-2
1	BLACK	PA6T-GF15	110 8P HEADER HSG FOR EPSILON	1	2-2005351-2

THIS DRAWING IS A CONTROLLED DOCUMENT.

DIMENSIONS: mm	TOLERANCES UNLESS OTHERWISE SPECIFIED: 0 PLC ± 1 PLC ± 2 PLC ± 3 PLC ± 4 PLC ± ANGLES ± FINISH -
MATERIAL	SEE TABLE

DWN DG JEONG
 CHK KT LIM
 APVD HG CHO
 PRODUCT SPEC -
 APPLICATION SPEC -
 WEIGHT -
 CUSTOMER DRAWING

STE TE Connectivity

NAME .110 8P/11P HEADER ASS'Y FOR EPSILON/SVW

SIZE A3 CAGE CODE 00779 DRAWING NO C-2005351 RESTRICTED TO -

SCALE 1:1 SHEET 1 OF 1 REV A2