

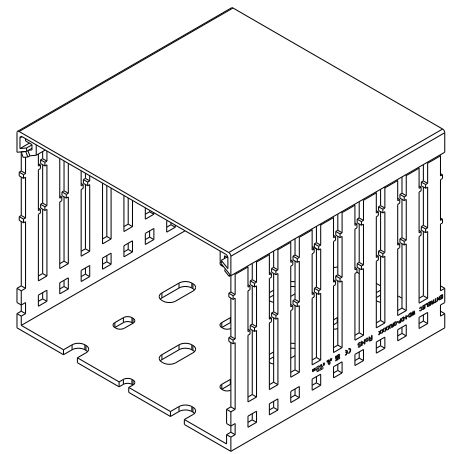

REVISIONS					
P	LTR	DESCRIPTION	DATE	DWN	APVD
	A	First release	17JUN2021	SL	VR

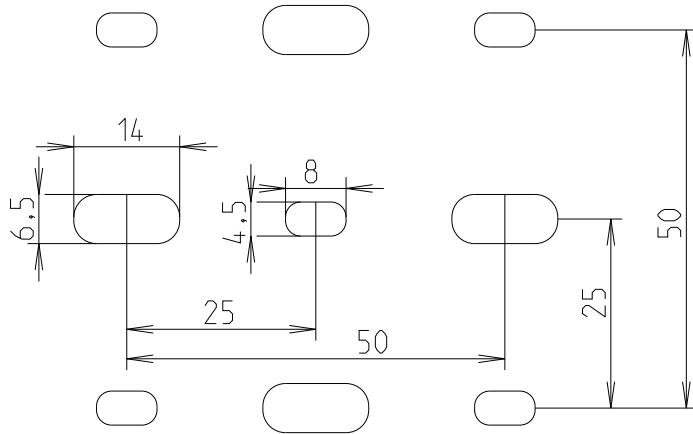
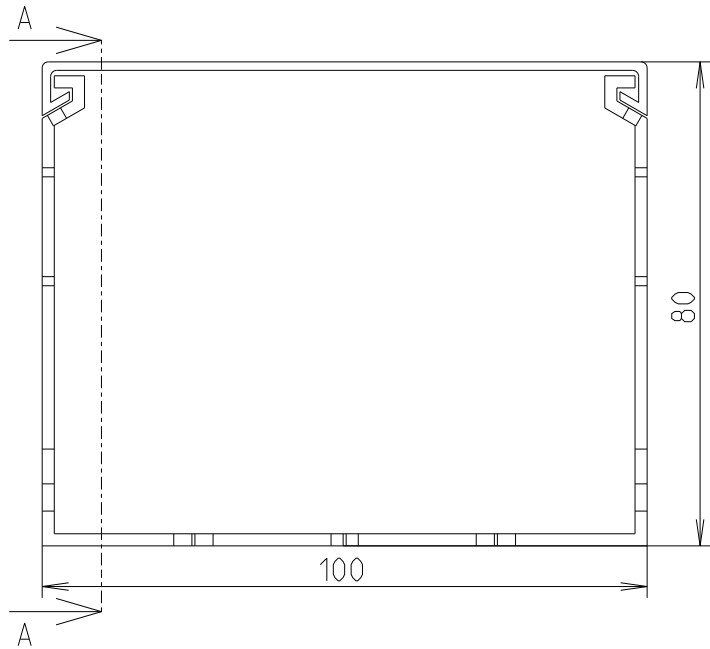
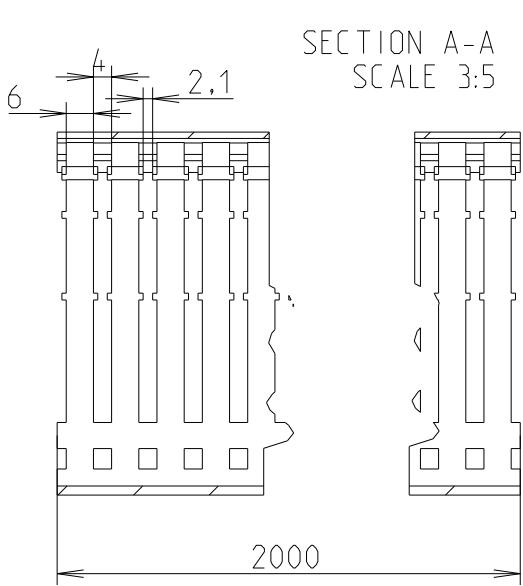

© 2021 TE Connectivity. All Rights Reserved.

1SET411003R0000

PART NO.

DIMENSIONS: mm		DWN 13-Sep-21 03:44:58 PM Deligny, Charlotte		MATERIAL PVC		FINISH -	
TOLERANCES UNLESS OTHERWISE SPECIFIED:		CHK Seguin, Laurene 2021-06-17		 TE Connectivity			
0 PLC ±		APVD Villard, Romain 2021-07-05					
1 PLC ±1		PRODUCT SPEC -		NAME WD-1-DP-GR1008			
2 PLC ±1		APPLICATION SPEC -		SIZE A 4		CAGE CODE 00779	
3 PLC ±1		WEIGHT -		DRAWING NO C=1SNP300190-0502		RESTRICTED TO -	
4 PLC ±1		CUSTOMER DRAWING		SCALE 1:1		SHEET 1 OF 1	
ANGLES ±						REV A1	