

REVISIONS			
REV	DESCRIPTION	DATE	APPROVED
01 ₂	REVISED	6/19/96	<i>[Signature]</i>

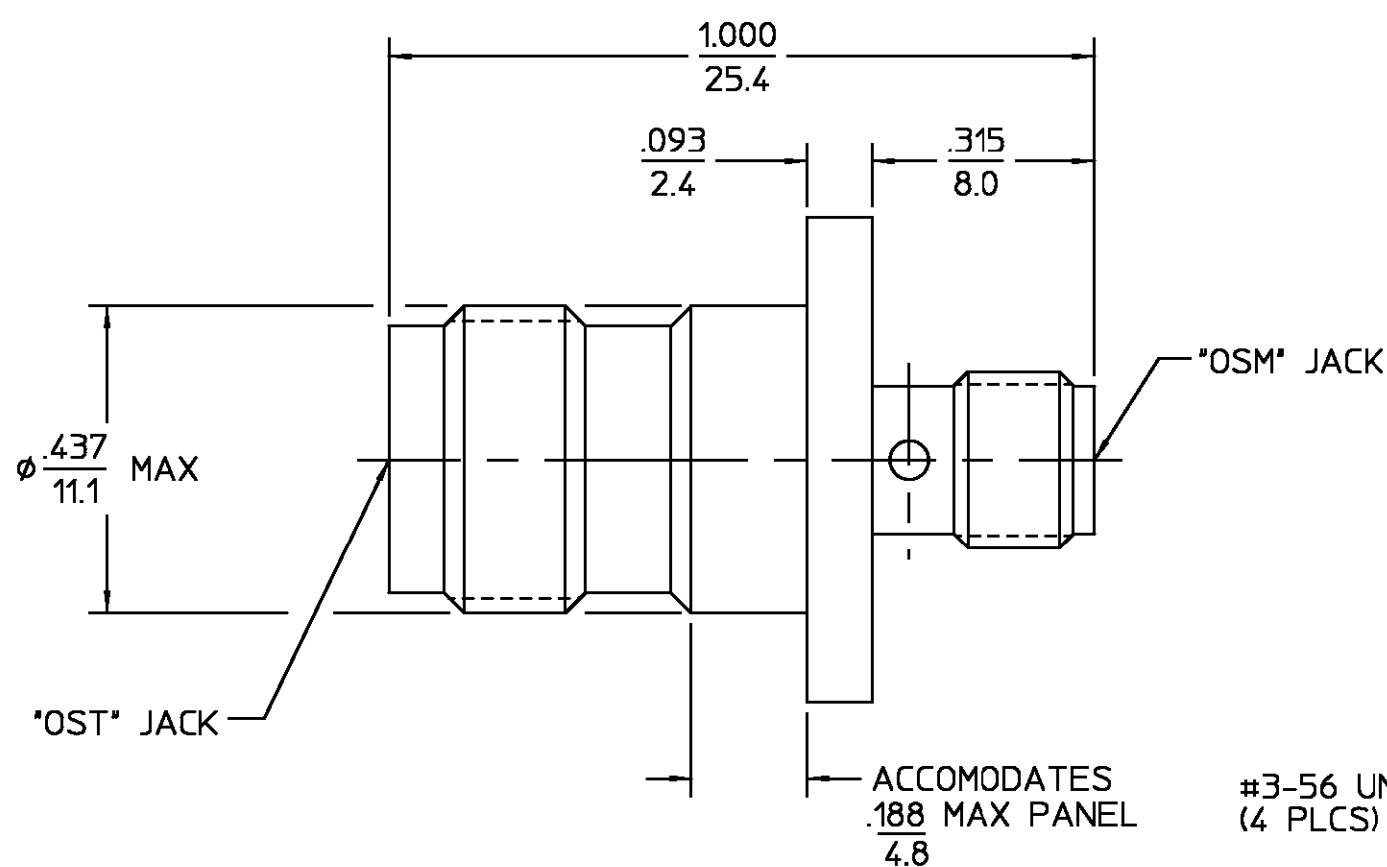

.XXX = in
XX.X = mm REF.

HOUSING	STAINLESS STEEL PER ASTM-A484 AND ASTM-A582, TYPE 303	PASSIVATE PER QQ-P-35
DIELECTRIC	TFE FLUOROCARBON PER ASTM-D-1457	N/A
CENTER CONTACT	BERYLLIUM COPPER PER ASTM-B-196 OR ASTM-B-197, ALLOY C17300, CONDITION H	GOLD PLATE PER MIL-G-45204
COMPONENT	MATERIAL	FINISH

UNLESS OTHERWISE SPECIFIED DIMENSIONS ARE IN INCHES FRAC. ± 1/64 DEC. ± .005 ANGLES ± 1°	DRAWN BY D. C.	DATE 1-12-79	AMP AMP Incorporated 140 Fourth Avenue Waltham, MA 02451-7599
	CHECKED BY R. M. F.	1-19-79	
	APPD BY G. H.	1-22-79	

NOTES:
1. CAPTURED CENTER CONTACT

These drawings and specifications are the property of M/A COM Interconnect Div. and shall not be reproduced or copied or used in whole or in part as the basis for the manufacture or sale of item(s) without written permission.	USE ASSY PROCEDURE	TITLE 'OSM' JACK TO 'OST' HI FREQ. (18 GHz) JACK ADAPTER	
	NO. A.P. N/A	SIZE B	CODE IDENT NO. 26805
		SCALE 4:1	3780-2242-00
			SHEET 1 OF 1