

---

**Terminating Size 12, Series “999”, SolderTact Contacts  
for Coaxial Cable: D-602-0151, 0151**

**1. Purpose and Scope**

This standard contains the termination procedures, inspection requirements, and rework procedures for the following Raychem SolderTact contacts for coaxial cable:

- D-602-0150 size 12 pin contacts for MIL-C-38999 Series I, II, III, and IV connectors.
- D-602-0151 size 12 socket contacts for MIL-C-38999 Series I, III, and IV connectors.

**2. References**

The following Raychem documents are referenced in this engineering standard:

- AA-400 Superheater Instructions.
- AD-1319 Holding Fixture Instructions.
- CV-5300 Mini-Gun Heating Tool Instructions.
- Visual Inspection Standards: Verification Photos.

**3. Application Equipment and Tools****3.1 Holding Fixtures and Adapters**

- AD-1319 holding fixture.
- AD-1567 holding fixture.
- AD-1566 repair holding fixture.
- AT-1319-24 adapter.

**3.2 Heating Tools**

- AA-400 SuperHeater with No. 979663 Mini -SolderSleeve reflector.
- CV-5300 MiniGun heater with MG-1 reflector.

**3.3 Miscellaneous Tools**

- Raychem AD-1575 conductor folding tool.
- Raychem AA-400-140 magnifier bracket assembly for use with AA-400 heating tool.

#### 4. Materials

- Solder: Sn63 or Sn60 per QQ-S-571
- Flux: Type RMA per MIL-F-14256 (Alpha #611 or equivalent)

#### 5. Termination Procedures

##### 5.1 Coaxial Cable Accomodation

D-602-0150 and D-602-0151 SolderTact contacts can be terminated to coaxial cable of the dimensions shown in Figures 5-1 and 5-2.

- Figure 5-1 applies to cables prepared using conventional stripping.
- Figure 5-2 applies to cables too small for conventional stripping.

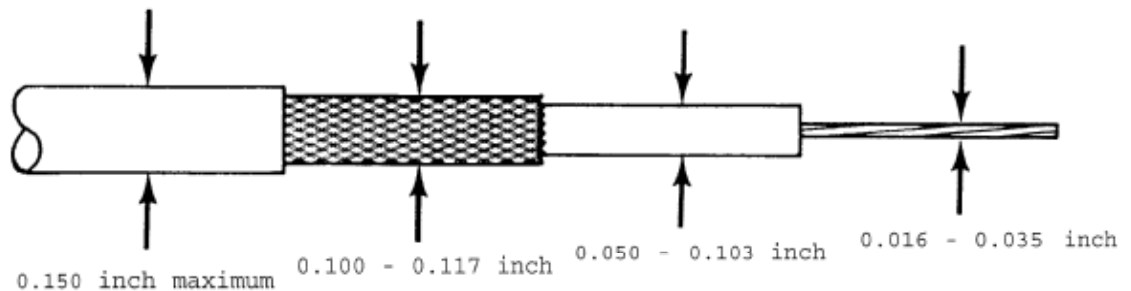

Figure 5-1. Coaxial Cable Size Accommodation: Conventional Stripping

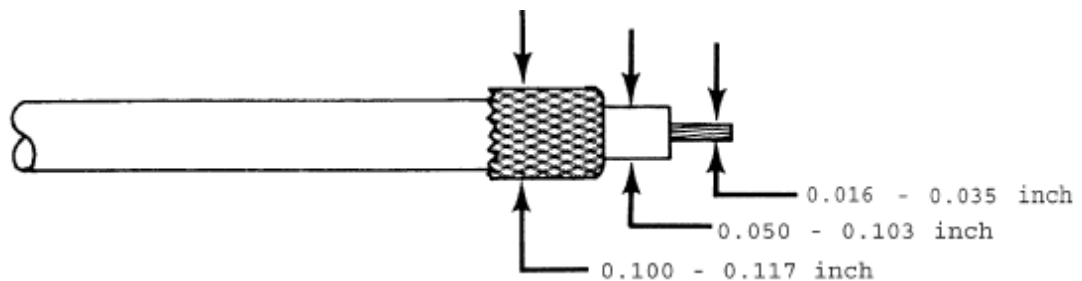

Figure 5-2. Coaxial Cable Size Accommodation: Fold-Back Stripping

5.2 Coaxial Cable Preparation

1. Determine the proper cable stripping method (conventional or braid fold-back), based on the diameter of the cable over the braid (See 5.1).
  2. Prepare the coaxial cable to the dimensions shown in the applicable example in Figure 5-3, based on the following criteria:
    1. Cable stripping method (from step 1 above).
    2. Cable center conductor size (from Table 5-1).
- NOTE: If the braid fold-back method is used, fold braid back over cable jacket and trim to the dimensions shown in Figure 5-3.

**Table 5-1. Coaxial Cable Stripping Dimensions**

| Coaxial Cable Stripping Method | Coaxial Cable Center Conductor Size | Stripping Example in Figure 5-3 |
|--------------------------------|-------------------------------------|---------------------------------|
| Standard                       | AWG 26 and larger                   | A                               |
|                                | AWG 28 and smaller                  | B                               |
| Braid fold-back                | AWG 26 and larger                   | C                               |
|                                | AWG 28 and smaller                  | D                               |

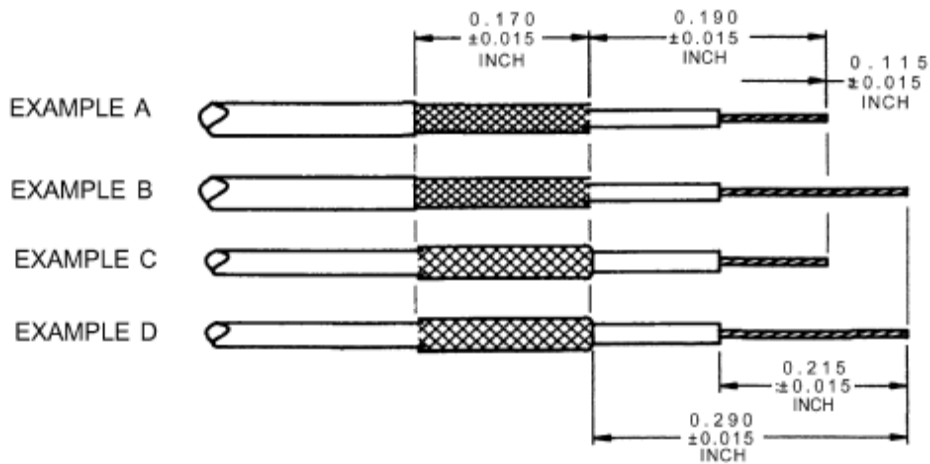

Figure 5-3. Coaxial Cable Stripping Dimensions (Refer to Table 5-1)

3. Straighten the center conductor and make sure that stranded center conductor is twisted into its original lay.
4. Pre-tin stranded center conductor and unplated solid center conductor with Sn63 solder per QQ-S-571.
  - Use RMA flux per MIL-F-14256 (Alpha #611 or equivalent).
5. Make sure that the shield braid is trimmed evenly and that no loose strands are extending out across the exposed dielectric or cable jacket.
6. Smooth the braid ends flat against the dielectric or cable jacket.
7. If the center conductor strip length is 0.215 inch as shown in examples B and D of Figure 5-3, fold the center conductor back on itself as shown in Figure 5-4.
  - The AD-1575 folding tool can be used to help start the fold; however, the fold must be tighter than can be obtained with the AD-1575 tool alone.

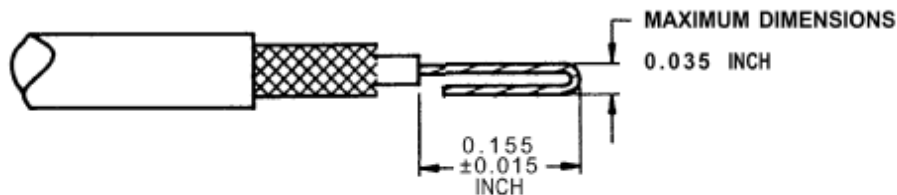

Figure 5-4. Small-Diameter Center Conductor Folded Back

### 5.3 Inserting Prepared Cable Into Contact

1. If required to improve wetting of tin plated shield, add a drop of RMA flux per MIL-F-14256 to the cable shield.
  - Poor wetting of shield is indicated by lack of proper solder fillets between cable shield and body of contact, or by lack of solder coverage on shield visible through inspection windows of contact.
2. Slip the contact over the end of the prepared cable, and carefully push the contact onto the cable until it stops.
  - Rotating the contact slightly during cable insertion will help prevent the braid from catching.
  - If the cable cannot be inserted as required, remove the contact from the cable and check for improper strip dimensions, splayed shield braid, or bent center conductor.
3. Inspect for proper insertion (Figure 5-5).
  - The center conductor must be visible through one of the forward inspection windows.
  - The distance from the rear of the contact outer body to the cable jacket insulation should not exceed 0.1 inch (2.5 mm).
  - If the cable cannot be inserted as required, remove the contact from the cable and check for improper strip dimensions, splayed shield braid, or bent center conductor.

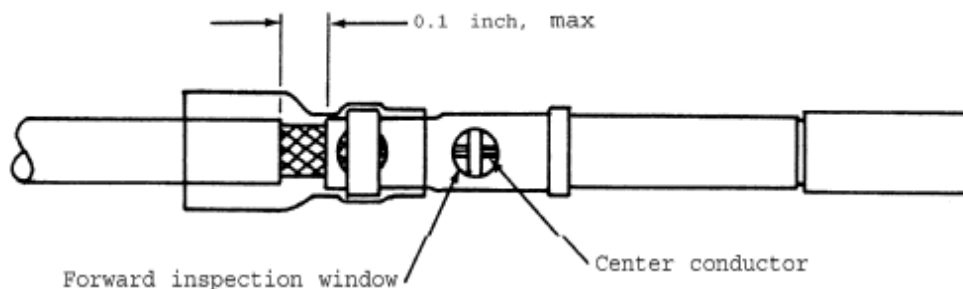

Figure 5-5. Inspection for proper cable insertion

**6. Heating Procedures****6.1 Holding Fixture and Adapter Selection**

Select the appropriate holding fixture and adapter for the contact to be terminated (Table 6-1).

- IMPORTANT: A suitable holding fixture must be used, to prevent damage to the contacts.
- The AD-1566 repair holding fixture is designed for use during the replacement of contacts where limited access prevents the use of the AD-1319 or AD-1567 fixture. The repair holding fixture does not provide cable clamping; therefore the cable must be secured during heating to prevent faulty solder terminations.

**Table 6-1. Holding Fixture and Adapter Selection**

| CONTACT                  | STANDARD HOLDING FIXTURE |            | REPAIR HOLDING FIXTURE |
|--------------------------|--------------------------|------------|------------------------|
|                          | BASIC FIXTURE            | ADAPTER    |                        |
| D-602-0150<br>D-602-0151 | AD-1319 or AD-1567       | AT-1319-24 | AD-1566                |

## 6.2 Holding Fixture Setup

### 6.2.1 Setup Procedures for AD-1319 Holding Fixture.

1. Install the AT-1319-24 adapter onto the AD-1319 holding fixture (See Figure 6-1).
2. Insert a contact in the adapter and set up the dimensions as shown in Figure 6-1.
  - Make sure that the contact is inserted in the appropriate end of the adapter:
    - a. D-602-0150 outer pin contacts in the “P” end.
    - b. D-602-0151 outer socket contacts in the “S” end.
  - If using a hot-air heating tool, the spacer collar is not needed, but may be left in place.

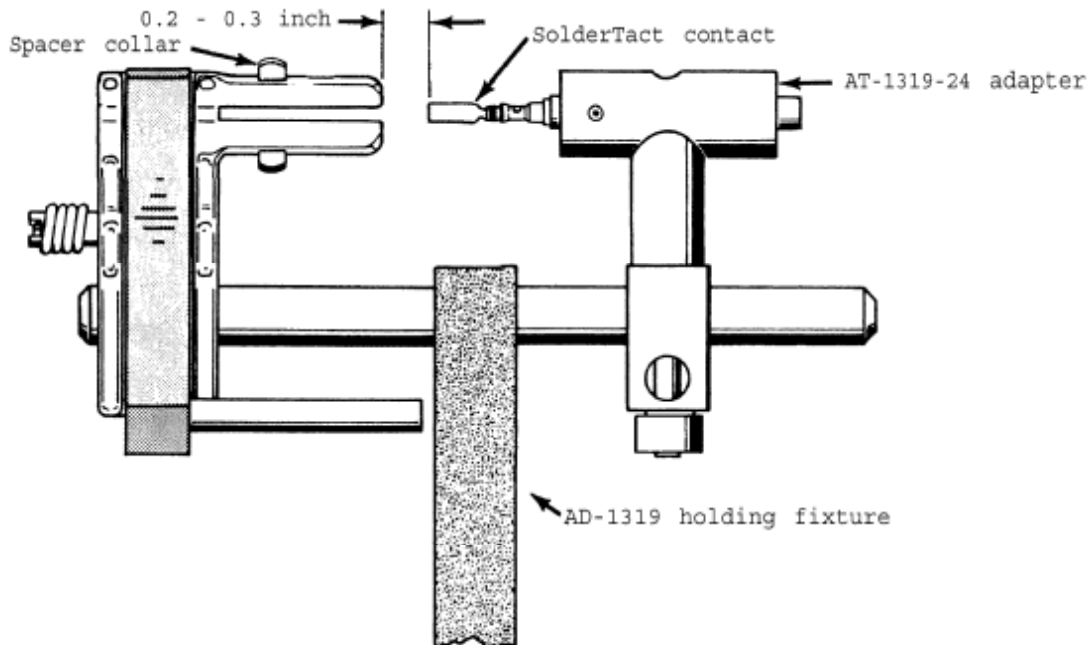

Figure 6-1. Setup Dimensions for AD-1319 Holding Fixture

## 6.2.2 Setup Procedures for AD-1567 Holding Fixture.

1. Install the AT-1319-24 adapter onto the AD-1567 holding fixture (see Figure 6-2).
  - If installing an adapter for the first time, it is necessary to separate the cylindrical parts of the adapter from the rectangular mounting base. The rectangular base is not used with the AD-1567 holding fixture.
  - Be sure to install two collars, one above the AD-1567 body and one below it.

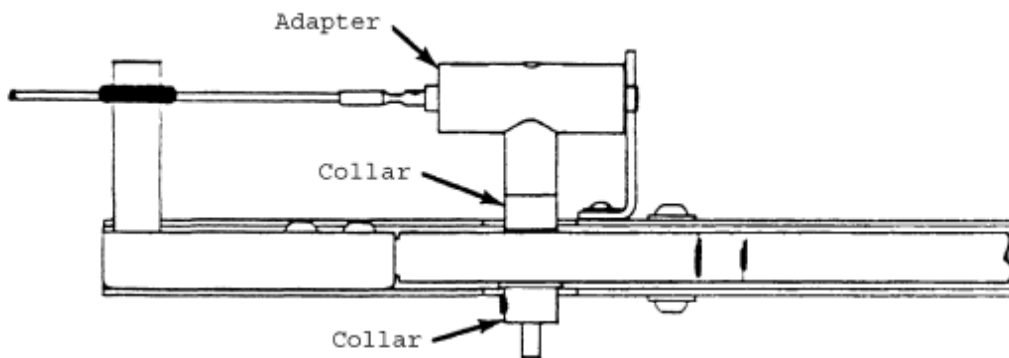

Figure 6-2. Adapter Installation on AD-1567 Holding Fixture



### 6.3 Heating Procedure

1. Insert the contact/cable assembly into the appropriate end of the adapter (Figure 6-3) or repair holding fixture (Figure 6-4).
  - a. D-602-0150 outer pin contacts in the "P" end.
  - b. D-602-0151 outer socket contacts in the "S" end.

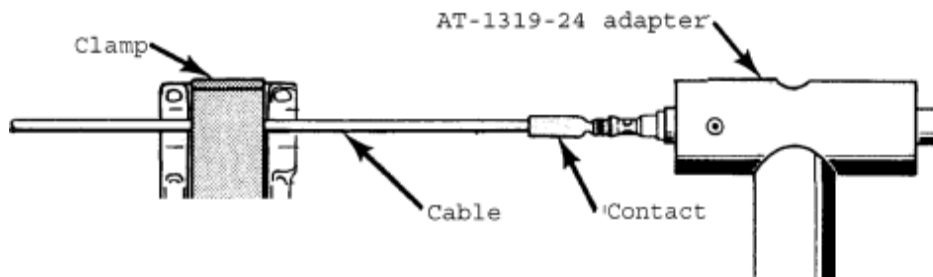

Figure 6-3. Contact Inserted into AT-1319-24 Adapter

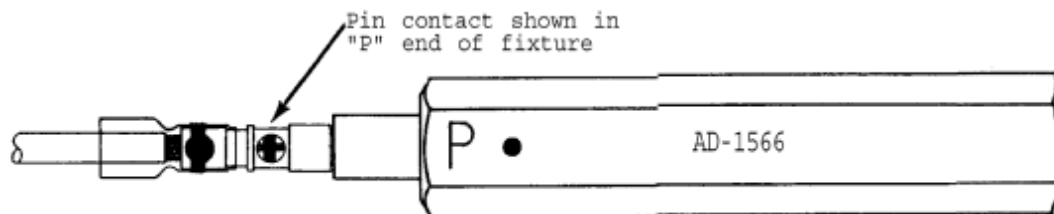

Figure 6-4. Contact Inserted into AD-1566 Repair Holding Fixture

2. Clamp the cable in the AD-1319 or AD-1567 holding fixture (if used)
  - The cable must remain fully inserted in the contact.
  - The contact must be fully inserted in the adapter.
  - The cable must be straight between the contact and the cable clamp.
3. Attach the appropriate reflector and other applicable accessories to the heating tool.
  - For the AA-400 SuperHeater: No. 979663 Mini-SolderSleeve reflector (required) and AA-400-140 magnifier bracket assembly (optional).
  - For the CV-5300 MiniGun: MG-1 reflector.
4. Turn the heating tool on and allow to warm up.
  - See instructions for tool used.

**CAUTION**

The heating tools have hot nozzle surfaces and produce hot air that can cause burns. To prevent burns, do not touch the nozzle, and keep hands and fingers away from the hot air stream.

- 5 Heat the contact as follows:
  - a. Using the holding fixture, position the contact in the heating tool reflector as shown in Figure 6-5, with the forward inspection window centered in the reflector.
  - b. Continue heating until the small solder preform in the forward inspection window has melted and flowed. The large solder preform in the rear inspection window should have melted and flowed by this time; if it has not, direct hot air at the rear inspection window until it does.
    - If contact is UNDERHEATED, there will be visible remnants of the original shapes of the solder preforms. An underheated contact must be reheated as directed in 8.1.
    - If contact is OVERHEATED, solder will wick away from the joint areas, leaving no solder fillets. An overheated contact must be removed and a new contact installed as directed in 8.2.



MINI SOLDER SLEEVE REFLECTOR FOR AA-400 SUPERHEATER

Center the contact front to back in upper half of slot

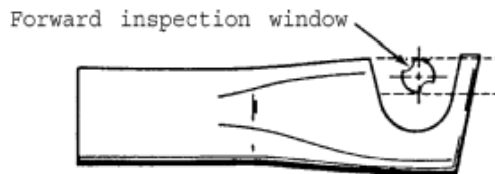

MG-1 REFLECTOR FOR CV-5300 MINIGUN

Figure 6-5 Contact Position in Heating Tool Reflector

6. After the contact has cooled for at least 10 seconds, remove the contact and cable from the holding fixture.
7. Inspect the completed termination according to Section 7.0.

**7.0 Inspection**

If contacts are underheated, overheated, or improperly assembled, they must be reworked as directed in Section 8.0.

**7.1 Inspection for Proper Assembly**

Inspect the completed termination for correct assembly according to the following criteria:

1. The cable shield must extend into the contact at least as far as the front edge of the rear inspection windows.
2. The center conductor must be visible through one of the forward inspection windows.

**7.2 Inspection for Proper Heating**

Inspect the completed termination for proper heating according to the following criteria:

1. The solder preform in the forward inspection windows must be melted and flowed so that:
  - a. None of the original preform shape remains.
    - Any remaining preform shape indicates underheating.
  - b. Solder fillet is visible between the center conductor and the inner contact soldering surface.
    - Insufficient visible solder indicates overheating.
2. The solder preform in the rear inspection window must be melted and flowed so that:
  - a. None of the original preform shape remains.
    - Any remaining preform shape indicates underheating.
    - The original position of the solder preform may be visible in the form of a contrasting band.
  - b. Solder fillet is visible between cable braid and contact body.
    - Insufficient visible solder indicates overheating.
3. The insulating sleeve must be fully shrunk onto the cable braid and jacket at the rear of the contact.

Continued next page.

4. The insulating sleeve must not be darkened so as to obscure the solder joints or hinder inspection.
  - If the solder joints cannot be seen due to darkening of the sleeve material, the termination is overheated.
5. The coaxial cable insulation must not show signs of damage or overheating outside of the insulating sleeve.

## **8. Repair and Rework**

### **8.1 Underheated Terminations**

Reheat underheated areas as directed in Section 6.0 and reinspect per Section 7.0. Avoid reheating areas that have been properly heated.

### **8.2 Overheated or Improperly Assembled Terminations**

1. Remove the contact from the cable as directed in Paragraph 8.3.
2. Check the cable for damage and incorrect stripping.
  - If the cable is damaged, cut off the damaged portion and restrip as described in Section 5.0.
3. If stripping is incorrect, restrip as required (Section 5.0).
4. Install new contact (Sections 5.0, 6.0, 7.0).

### **8.3 Removing Contact From-Coaxial Cable**

1. Use a sharp knife or razor blade to score the outer insulating sleeve full length on two opposite sides of the contact.
  - Avoid cutting into cable jacket.
2. Peel off the outer insulating sleeve.

#### **CAUTION**

Safety glasses must be worn during the following operation. Hot solder can fly off the wires and cause burns to unprotected eyes.

3. Holding the contact with pliers, heat the contact until the solder melts, and quickly pull the heated contact off the cable.