

Singlemode Fiber Optic Cable Assemblies Terminated With LC Connectors**1. INTRODUCTION**

1.1. Purpose

Singlemode fiber optic cable assemblies, terminated with LC connectors, were tested to determine their conformance to the requirements stated in this document. The connectors used a right angle strain relief and were terminated to 1.6 mm simplex cable.

1.2. Scope

This report covers optical and mechanical performance of singlemode fiber optic cable assemblies, which consisted of LC connectors with right angle strain reliefs and 1.6 mm simplex cable, manufactured by the Fiber Optic Group of Tyco Electronics. Testing was performed between July 7, 2000 and August 31, 2000. The test file number for this testing is OIL B022041-004.

1.3. Conclusion

The singlemode fiber optic cable assemblies terminated with LC connectors, listed in paragraph 1.5, meet the optical and mechanical performance requirements stated in this document.

1.4. Product Description

Tyco Electronics singlemode fiber optic cable assemblies terminated with LC connectors are used in telephone company central offices, CATV head-ends, inter-building backbones and customer premise applications.

1.5. Test Samples

Samples were constructed by Tyco Electronics Fiber Optic Group. Fiber used in the following tests was 9/125 μm singlemode optical fiber. The following sample quantities were used for the test group.

Test Group	1
Fiber Type	Singlemode
Cable Type	1.6 mm Simplex
Cable Assembly PN	1457118-3
Coupling Receptacle PN	1457062-1
Test cable length (m)	2
Test samples required	8
Source wavelengths	1310 nm 1550 nm

Figure 1

1.6. Design Verification Test Sequence

Test or Examination	Test Group (a)
	1
Test Sequence (b)	
Examination of Product	1
Initial Attenuation	2
Initial Return Loss	3
Transmission with Applied Load - 0.55 lb _f	4
Transmission with Applied Load - 1.54 lb _f	5
Transmission with Applied Load - 3.30 lb _f	6
Transmission with Applied Load - 4.40 lb _f	7
End of Test Optical Measurements	8

NOTE (a) See paragraph 1.5.
 (b) Numbers indicate sequence in which tests are performed.

Figure 2

2. SUMMARY OF TESTING

2.1. Examination of Product

All samples submitted for testing were built by the Fiber Optic Group of Tyco Electronics. The samples were inspected for conformance to the production print.

2.2. Attenuation

All loss measurements met the stated performance requirement. The maximum allowable attenuation is 0.40 dB. Attenuation was measured at 1310 nm and 1550 nm wavelengths.

Test Group	1310 nm Attenuation Actual (dB)		1550 nm Attenuation Actual (dB)	
	Average	Maximum	Average	Maximum
1	0.07	0.25	0.08	0.33

2.3. Return Loss

All return loss measurements met the stated performance requirement. The minimum allowable return loss is 40 dB. Return loss was measured at 1310 nm and 1550 nm wavelengths.

Test Group	1310 nm Return Loss Actual (dB)			1550 nm Return Loss Actual (dB)		
	Minimum	Average	Maximum	Minimum	Average	Maximum
1	49.2	52.4	55.8	51.5	54.0	56.7

2.4. Transmission with Applied Load

At all load levels and load angles, all samples met the stated performance requirements. All change in attenuation measurements met the maximum allowed requirement. The maximum allowable change in attenuation is 0.5 dB. The minimum permitted return loss during test is 40 dB. In addition to the summary below, test results are also plotted in the Appendix.

Test Group	1310 nm Maximum Change in Attenuation Actual (dB)			1550 nm Maximum Change in Attenuation Actual (dB)		
	0°	90°	135°	0°	90°	135°
1	-0.09	0.11	0.02	0.14	0.25	0.34

Test Group	1310 nm Minimum Return Loss Actual (dB)			1550 nm Minimum Return Loss Actual (dB)		
	0°	90°	135°	0°	90°	135°
1	48.3	48.3	48.7	50.6	50.5	50.9

2.5. End of Test Optical Measurements

All loss measurements met the stated performance requirement. The maximum permitted attenuation is 0.50 dB. All return loss measurements met the stated performance requirement. The minimum permitted return loss is 40 dB. Attenuation and return loss were measured at 1310 nm and 1550 nm wavelengths.

Test Group	1310 nm Attenuation Actual (dB)		1550 nm Attenuation Actual (dB)	
	Average	Maximum	Average	Maximum
1	0.05	0.22	0.07	0.35

Test Group	1310 nm Return Loss Actual (dB)			1550 nm Return Loss Actual (dB)		
	Minimum	Average	Maximum	Minimum	Average	Maximum
1	48.5	52.1	55.8	50.8	53.8	56.7

3. TEST METHODS

All optical measurements were performed with the utilization of a singlemode test system. This measurement facility is compliant with Telcordia GR-326-CORE. Loss and reflectance was measured at 1310 nm and 1550 nm wavelengths. Following the installation of the samples, sequential testing was performed.

3.1. Examination of Product

Product drawings and quality inspection plans were used to examine the samples. They were examined visually and functionally.

3.2. Attenuation

Initial optical power, through the selected launch connector fiber, was measured. The connector assembly was then mated and final optical power measured from the receive-side cable assembly. Cable assembly attenuation loss was calculated by taking the difference between the initial measurement and the final measurement.

3.3. Return Loss

Return loss measurements were performed using optical time domain reflectometry.

3.4. Transmission with Applied Tensile Load

A. Test Sequence 4

A 0.55 lb_f [0.25 kg_f] load was applied to the receive side cable at 0, 90 and 135 degrees normal to the mated samples, using a 7.5 cm diameter mandrel. Attenuation and return loss were recorded before, during (after the load was applied for a minimum of 10 seconds) and after testing each load and angle combination.

B. Test Sequence 5

A 1.54 lb_f [0.7 kg_f] load was applied to the receive side cable at 0 and 90 degrees normal to the mated samples, using a 7.5 cm diameter mandrel. Attenuation and return loss were recorded before, during (after the load was applied for a minimum of 10 seconds) and after testing each load and angle combination.

C. Test Sequence 6

A 3.30 lb_f [1.5 kg_f] load was applied to the receive side cable at 0 and 90 degrees normal to the mated samples, using a 7.5 cm diameter mandrel. Attenuation and return loss were recorded before, during (after the load was applied for a minimum of 10 seconds) and after testing each load and angle combination.

D. Test Sequence 7

A 4.40 lb_f [2.0 kg_f] load was applied to the receive side cable at 0 and 90 degrees normal to the mated samples, using a 7.5 cm diameter mandrel. Attenuation and return loss were recorded before, during (after the load was applied for a minimum of 10 seconds) and after testing each load and angle combination.

APPENDIX

Change in Attenuation during Zero Degree Tensile Load
LC Simplex Connectors with Right Angle Strain Reliefs Terminated to 1.6mm Jacket

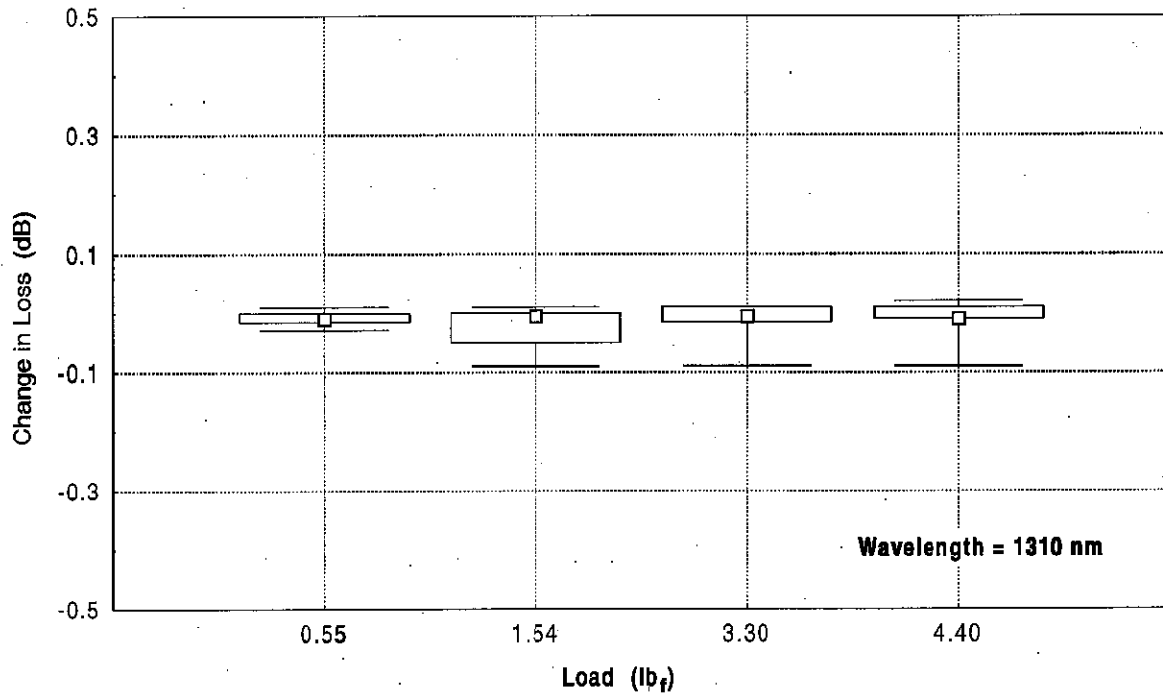

Change in Attenuation during Zero Degree Tensile Load
LC Simplex Connectors with Right Angle Strain Reliefs Terminated to 1.6mm Jacket

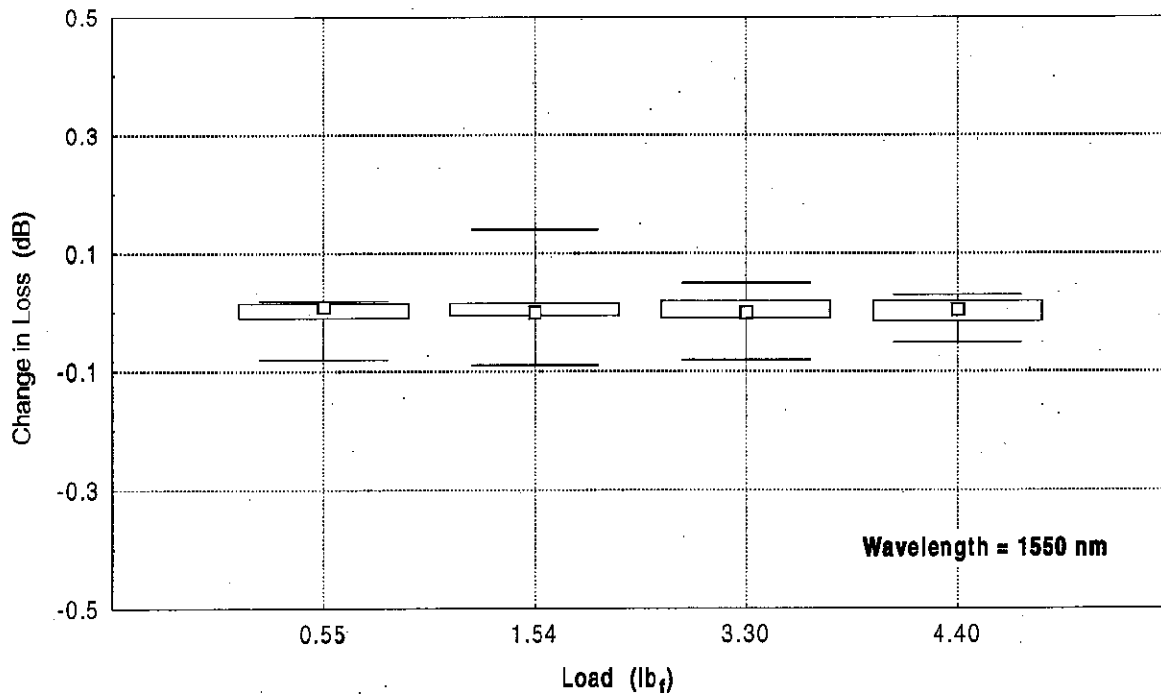

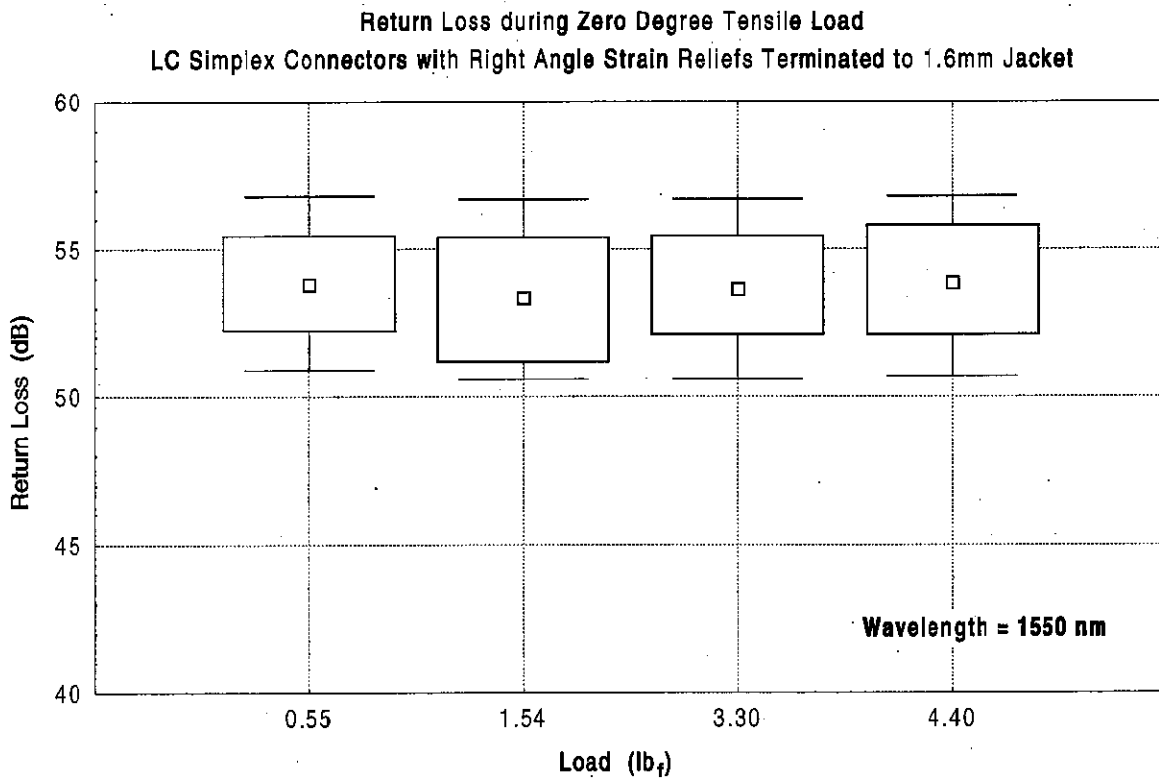
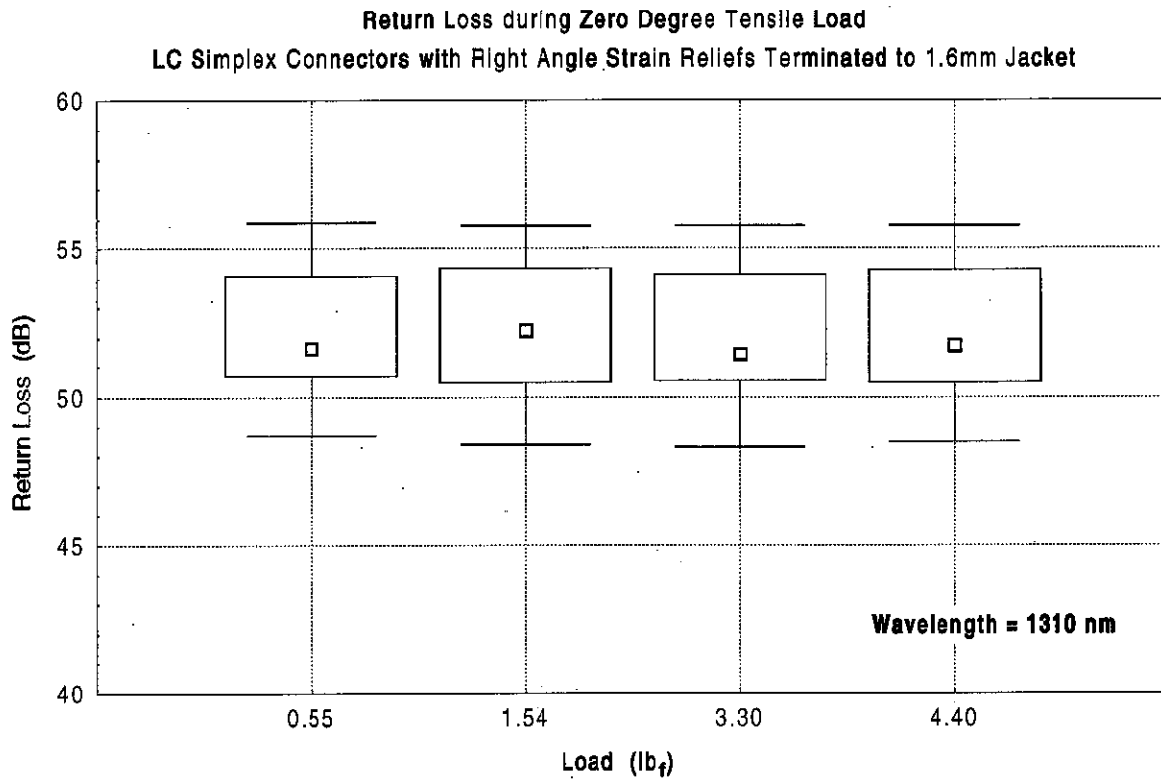

Average Attenuation in Transmission during Zero Degree Tensile Load
LC Simplex Connectors with Right Angle Strain Reliefs Terminated to 1.6mm Jacket

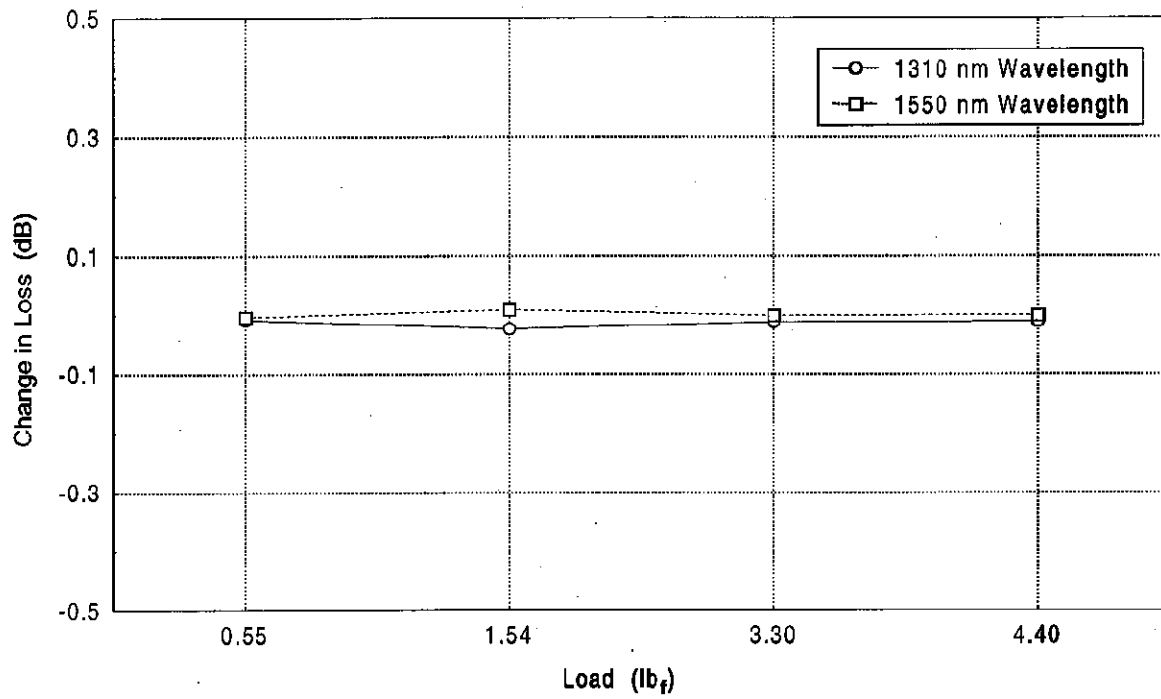

Average Return Loss during Zero Degree Tensile Load
LC Simplex Connectors with Right Angle Strain Reliefs Terminated to 1.6mm Jacket

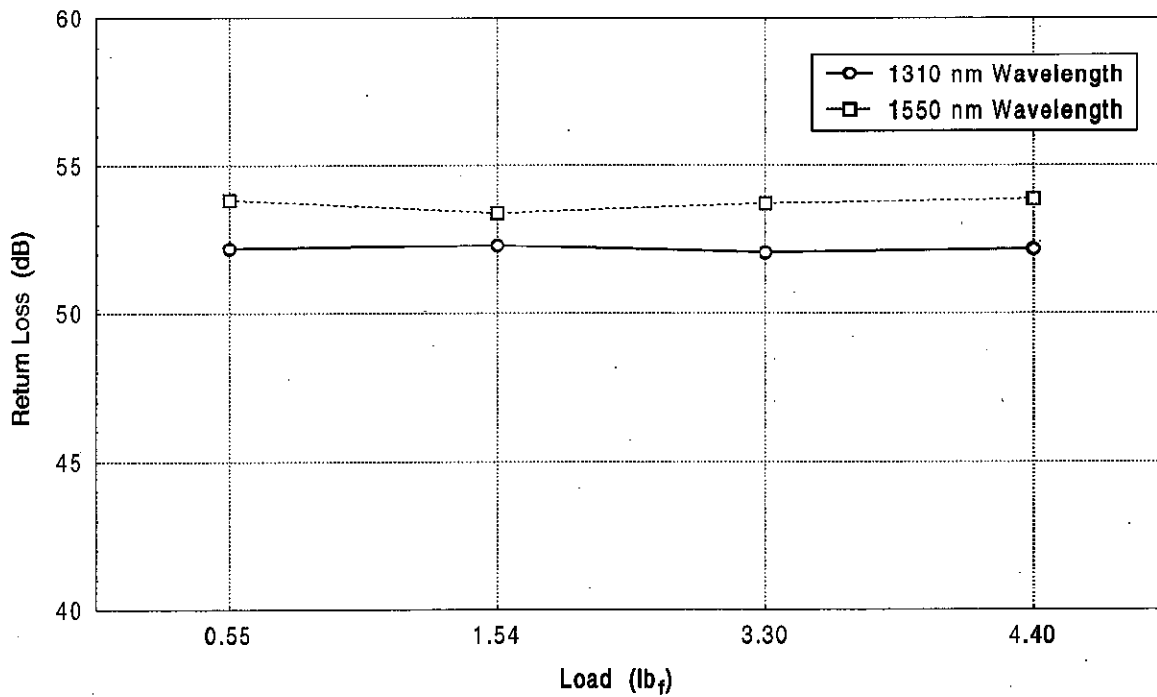

Change in Attenuation during 90-degree Tensile Load
 LC Simplex Connectors with Right Angle Strain Reliefs Terminated to 1.6mm Jacket

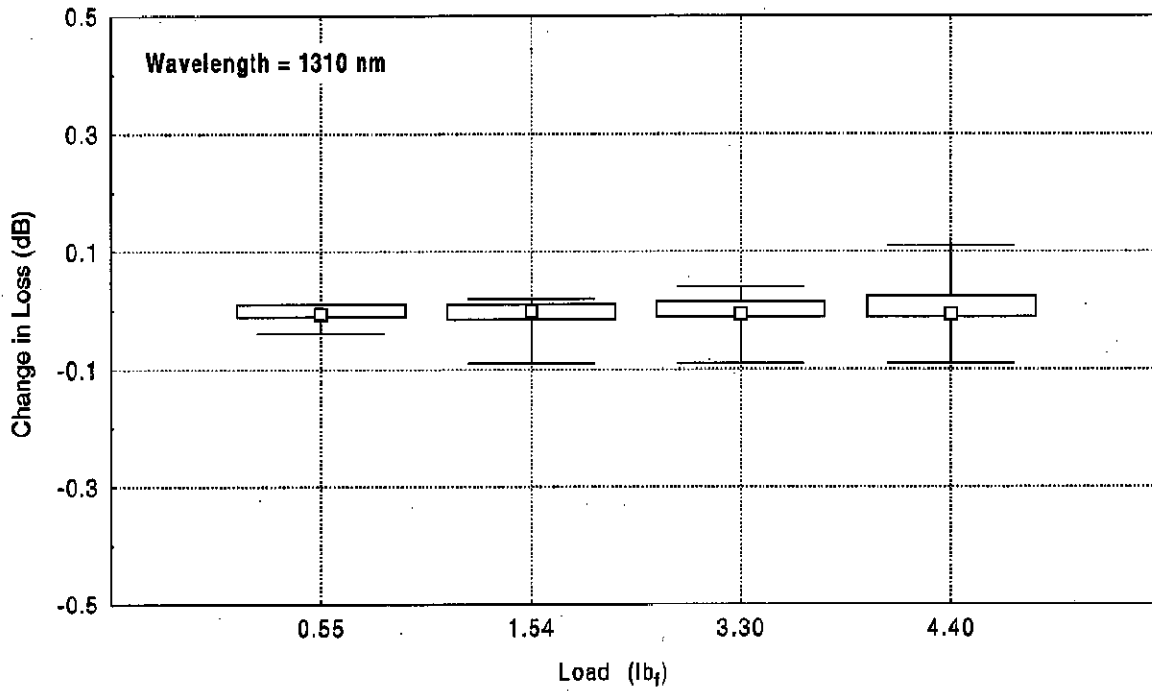

Change in Attenuation during 90-degree Tensile Load
 LC Simplex Connectors with Right Angle Strain Reliefs Terminated to 1.6mm Jacket

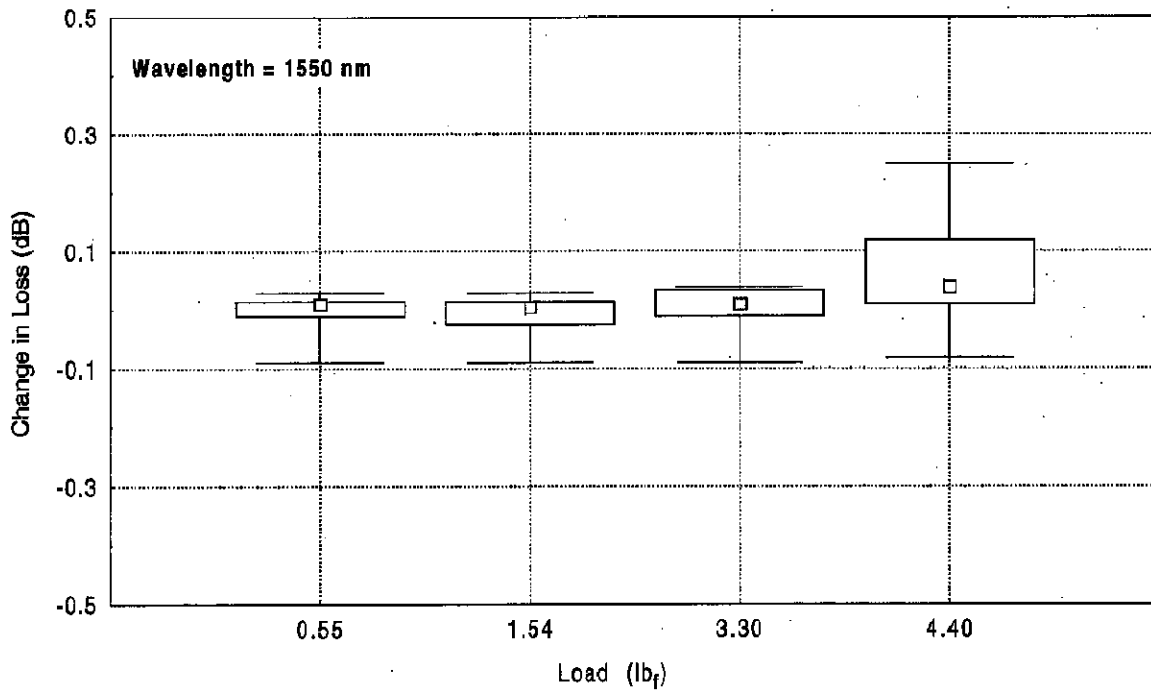

Return Loss during 90-degree Tensile Load
 LC Simplex Connectors with Right Angle Strain Reliefs Terminated to 1.6mm Jacket

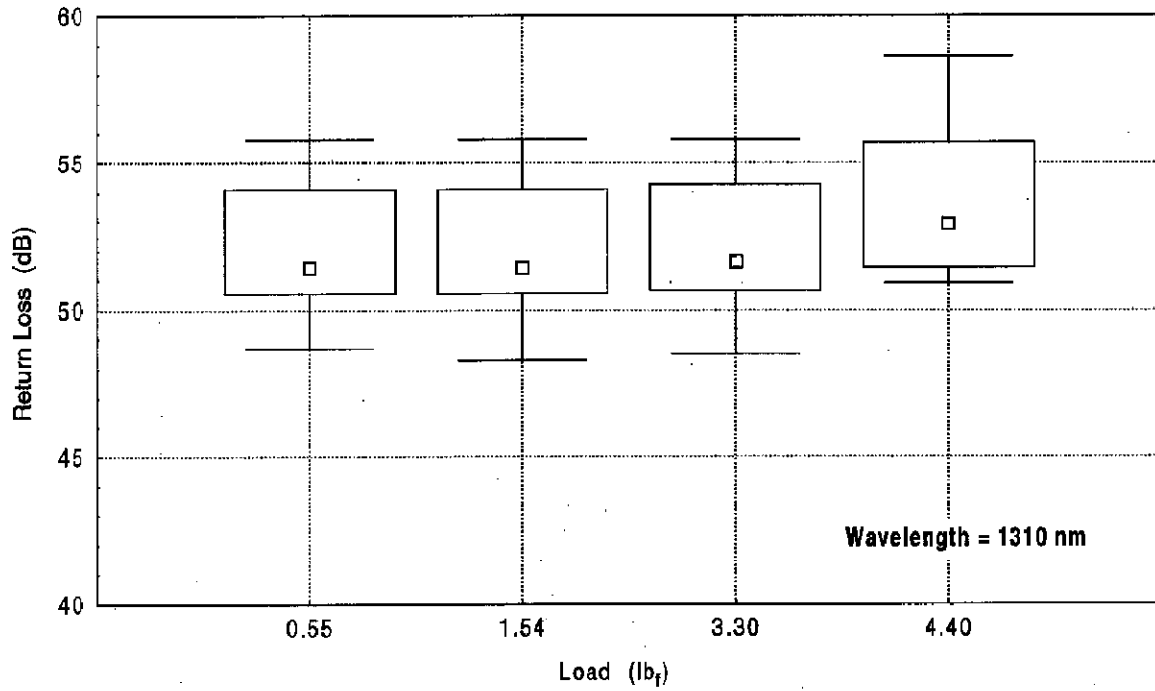

Return Loss during 90-degree Tensile Load
 LC Simplex Connectors with Right Angle Strain Reliefs Terminated to 1.6mm Jacket

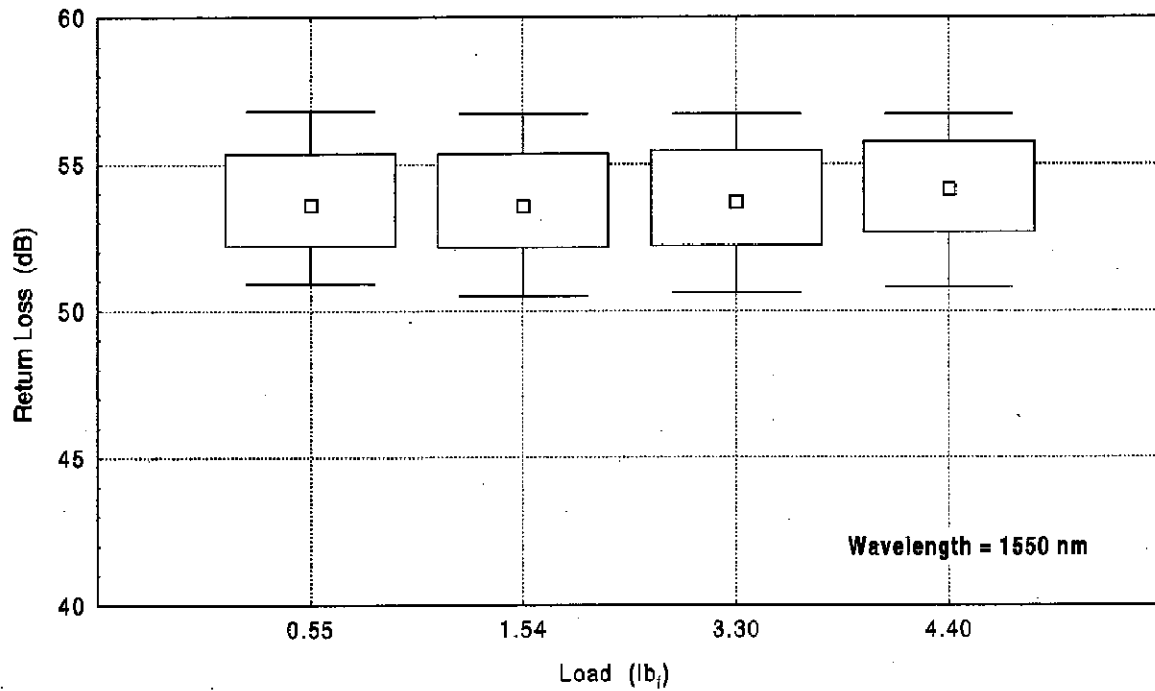

Average Change in Attenuation during 90-degree Tensile Load
 LC Simplex Connectors with Right Angle Strain Reliefs Terminated to 1.6mm Jacket

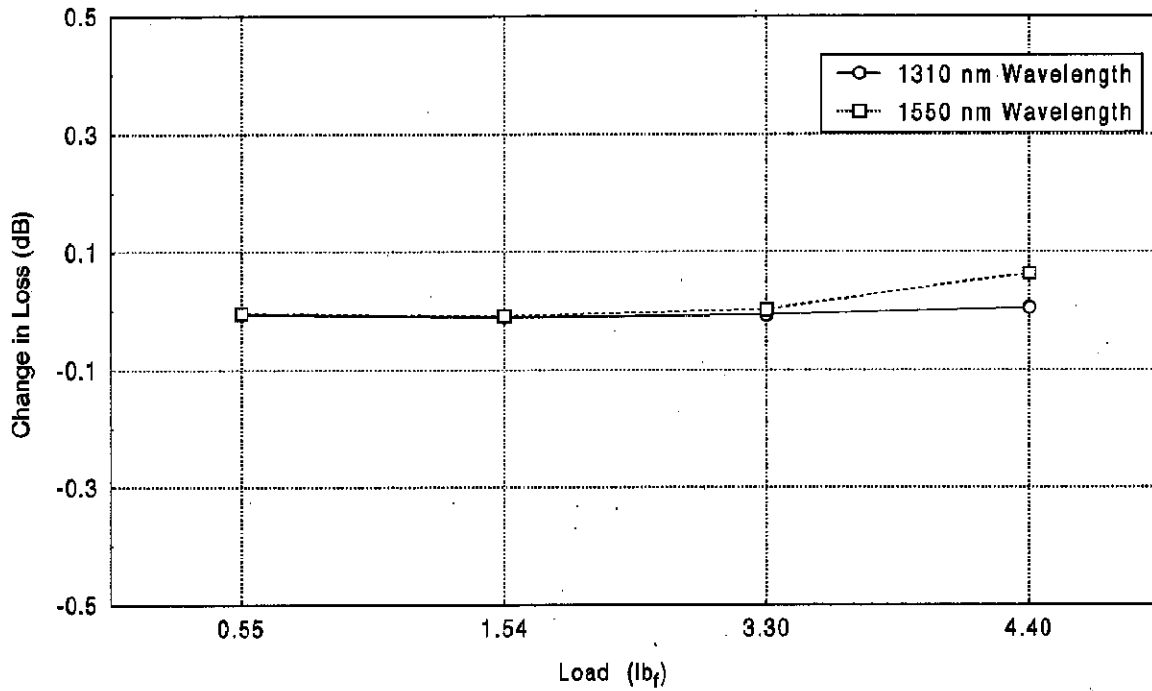

Average Return Loss during 90-degree Tensile Load
 LC Simplex Connectors with Right Angle Strain Reliefs Terminated to 1.6mm Jacket

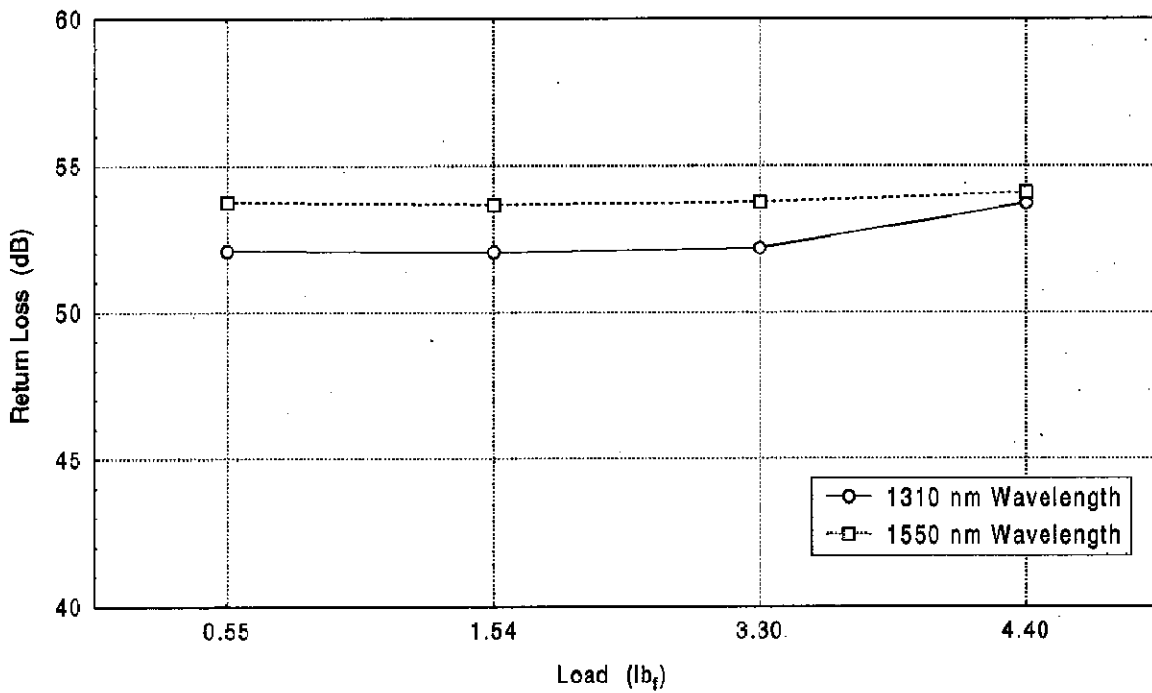

Change in Attenuation during 135-degree Tensile Load
 LC Simplex Connectors with Right Angle Strain Reliefs Terminated to 1.6mm Jacket

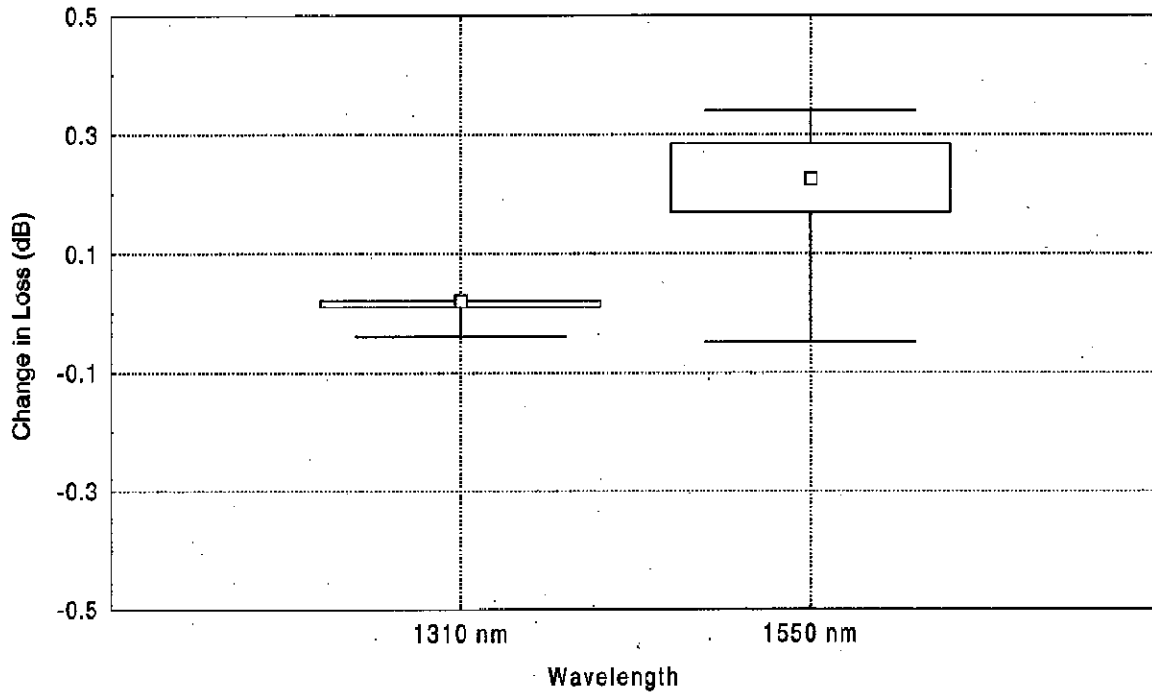

Return Loss during 135-degree Tensile Load
 LC Simplex Connectors with Right Angle Strain Reliefs Terminated to 1.6mm Jacket

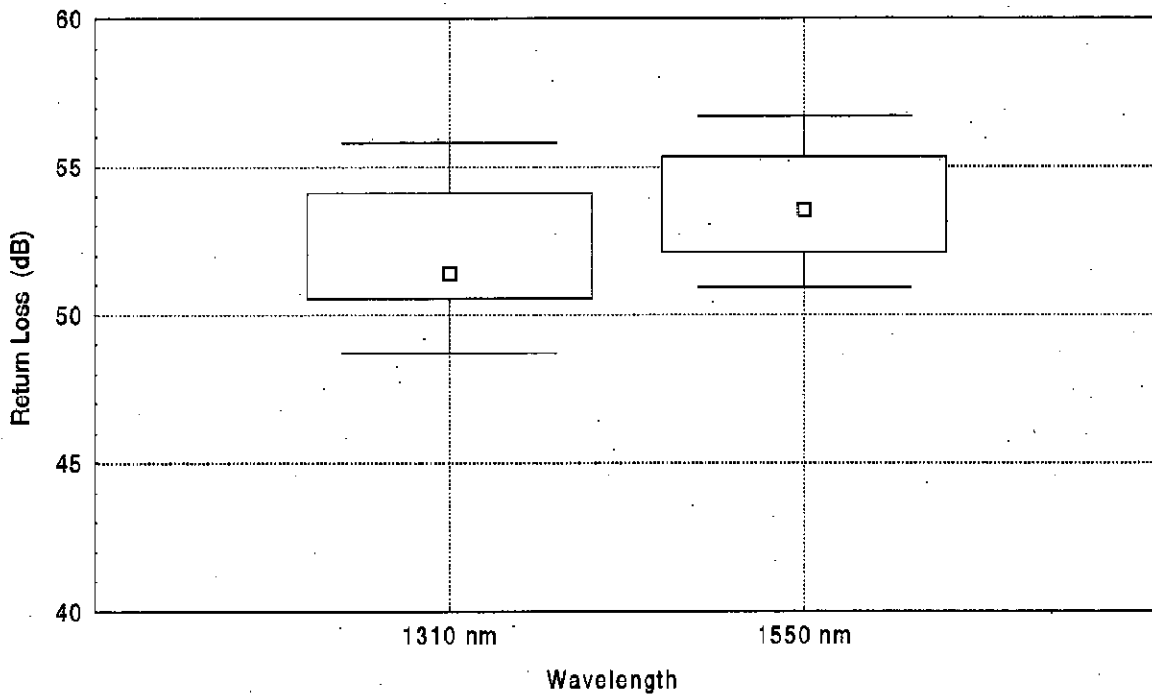

Comparative Attenuation Before and After Test Sequence
 LC Simplex Connectors with Right Angle Strain Reliefs Terminated to 1.6mm Jacket

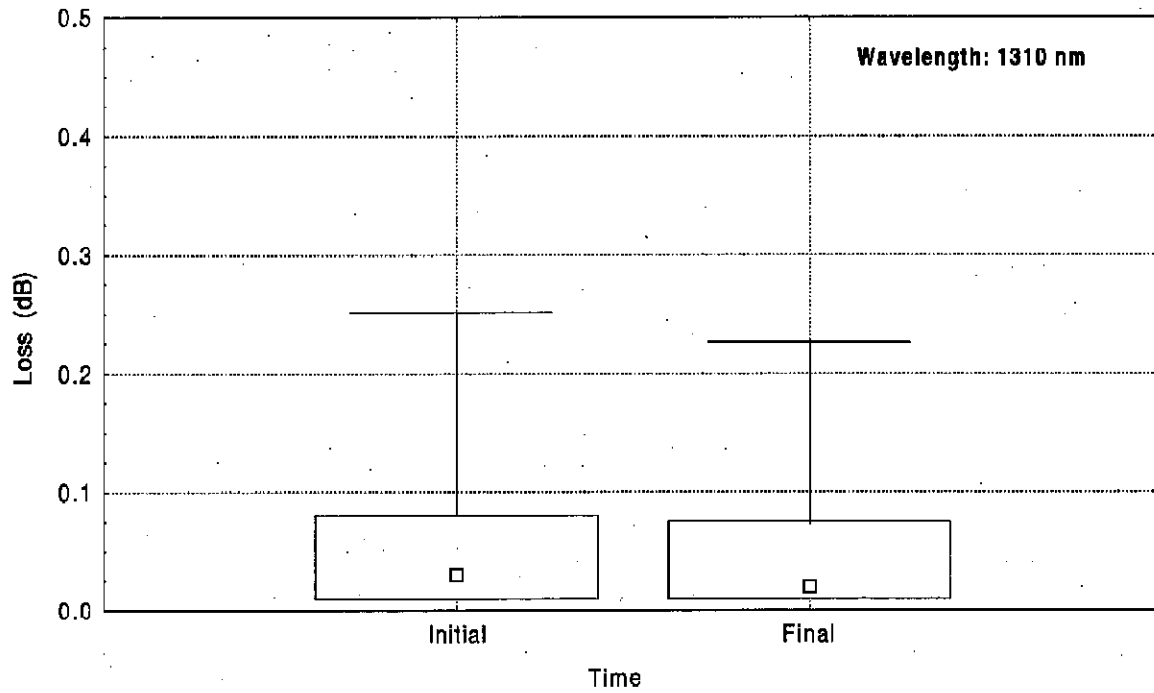

Comparative Attenuation Before and After Test Sequence
 LC Simplex Connectors with Right Angle Strain Reliefs Terminated to 1.6mm Jacket

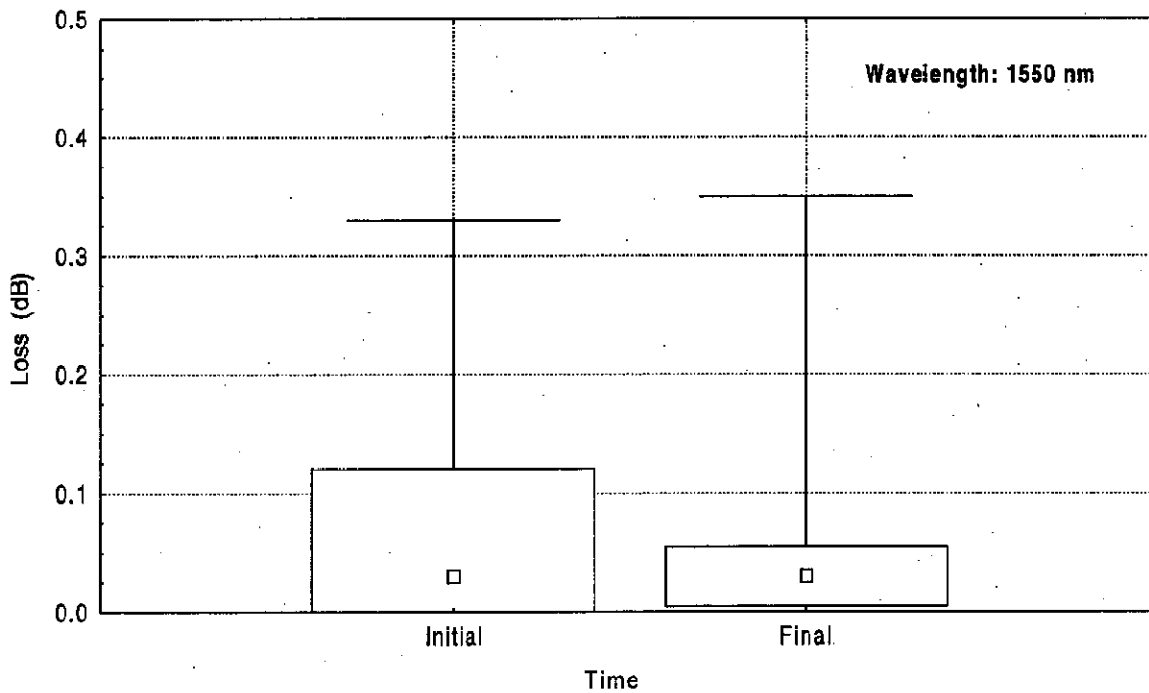

Comparative Return Loss Before and After Test Sequence
 LC Simplex Connectors with Right Angle Strain Reliefs Terminated to 1.6mm Jacket

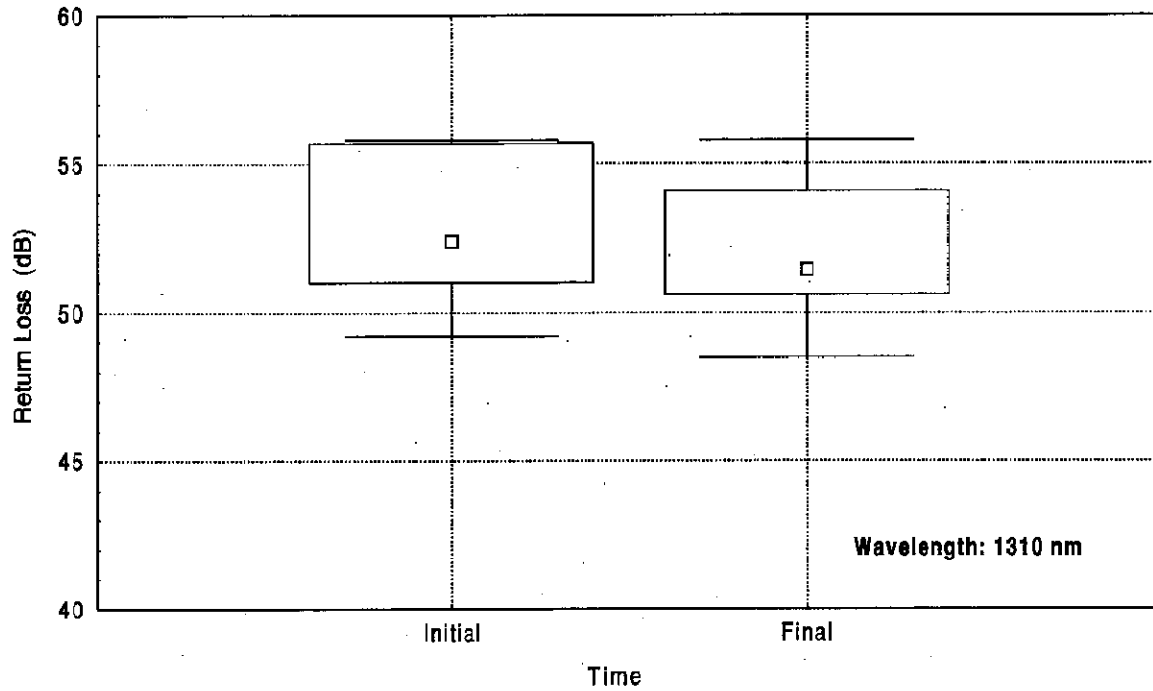

Comparative Return Loss Before and After Test Sequence
 LC Simplex Connectors with Right Angle Strain Reliefs Terminated to 1.6mm Jacket

