

.040 Series, Multilock I/O Connector, Mark II**Customer Manual**

Note: This manual is subject to change without prior notification.

CONTENTS

No.	Section	Page
1.	Product Names and Part Numbers	2
	1.1 Housing	2
	1.2 Contact	2
	1.3 Product Part Numbers	2
2.	Contact and Housing Inspection	3
	2.1 AMP Products Shipping Inspection	3
	2.2 Customer Receiving Inspection	3
3.	Crimping Operation	4
	3.1 Storage and Handling	4
	3.2 Documents for Crimp Control (Wire Stripping and Wire Crimp Inspection)	5
	3.3 Crimped Lead Inspection Prior to Harness Assembly	8
4.	Harness Assembly Operation	9
	4.1 Loading of On-Wire Contacts into Housing	9
	4.2 Double Lock Setting	10
	4.3 Extracting Contacts from the Housing	11
	4.3.1 Unlocking double lock ratchet	11
	4.3.2 Extracting contacts	12
	4.4 Harness Product Control	12
5.	Mounting On Vehicles	13
	5.1 Acceptance Inspection	13
	5.2 Mounting Operation Control	13
	5.3 Unmating Connectors	13

1. Product Names and Part Numbers

1.1. Housing

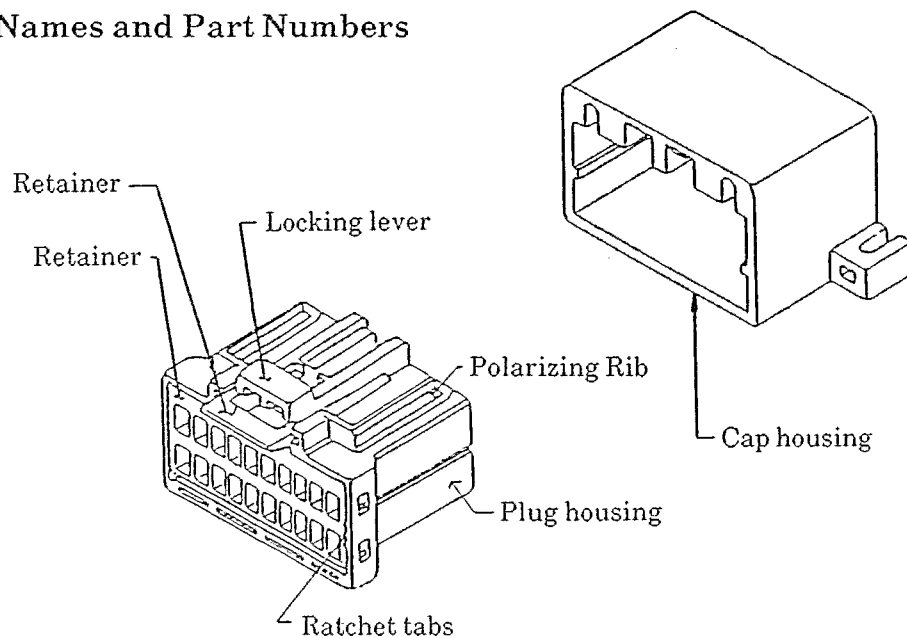

1.2 Contact

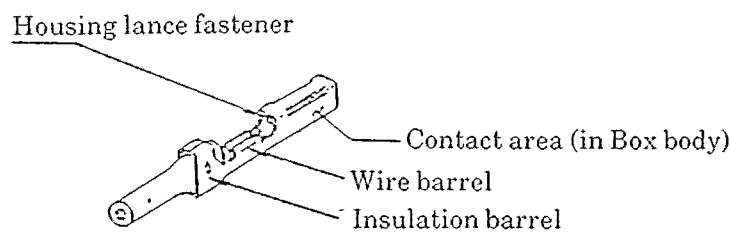

1.3 Product Part Numbers

1.3.1 Housing

Name	Model	Wire Size	Insulation Dia.
.040 Receptacle	173681-□	AVS 0.3 to 0.5 mm ²	1.8 - 2.0 mm ²
.040 Receptacle	173716-□		

1.3.2 Housing

Name	Part Number	Remarks
8 Pos. Plug Housing	175964-□	
1 2 Pos. Plug Housing	175965-□	
1 6 Pos. Plug Housing	175966-□	
2 0 Pos. Plug Housing	175967-□	
8 Pos. Cap Housing Horizontal Type	175973-□	Wire-to-Board
1 2 Pos. Cap Housing Horizontal Type	175974-□	Wire-to-Board
1 6 Pos. Cap Housing Horizontal Type	175615-□	Wire-to-Board
2 0 Pos. Cap Housing Horizontal Type	175975-□	Wire-to-Board
2 8 Pos. Cap Housing Horizontal Type	175976-□	Wire-to-Board
3 6 Pos. Cap Housing Horizontal Type	174912-□	Wire-to-Board
3 6 Pos. Cap Housing Vertical Type	175977-□	Wire-to-Board
3 6 Pos. Cap Housing Holder Vertical Type	1747211-□	Wire-to-Board

2. Contacts and Housing Inspection

2.1 AMP Products Shipping Inspection

We conduct inspections referring to specific standards, under strict statistical management, and according to our quality control regulations, to maintain an overall lot control. In principle, each package is marked with manufacturing date to facilitate tracing production history using inspection, manufacturing, and machinery adjustment records. Manufacturing date code (denoted as date code) is as follows:

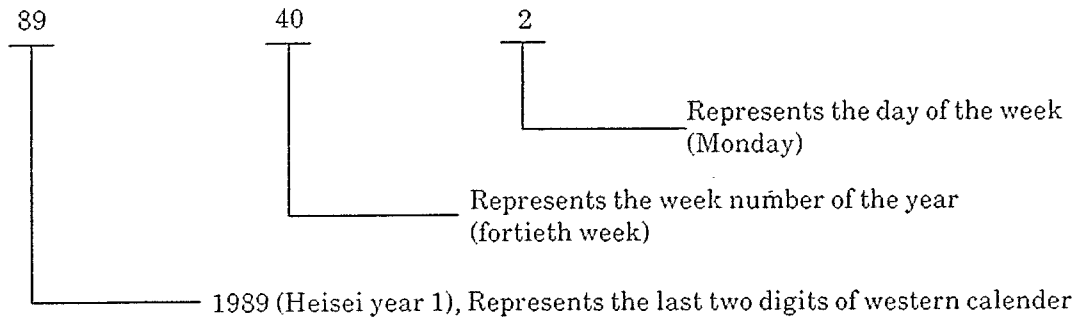

2.2 Customer Receiving Inspection

In addition, the customers should conduct at least the following receiving inspections based on the specific customer drawings.

(Terminal)

Item	Inspection Description and Methods	Measuring Methods
Appearance Inspection	1) Shape	Visual inspection
	2) Plated condition	Visual inspection
	3) Reeled condition	Visual inspection
Dimension Inspection	1) Wire barrel width and height	Vernier Calipers
	2) Insulation barrel width and height	Vernier Calipers
	3) Locking lever height	Vernier Calipers

When reels are delivered, each reel is classified by date code and inspected visually for AQL 4% based on II (MIL-STD-105) standards, including additional inspection of 5 contacts on reel ends. The lot may be accepted if all reels successfully pass the inspection.

(Housing)

Item	Inspection Description and Methods	Measuring Methods
Visual Inspection	1) Burrs, discoloring, and deformation	Visual inspection
	2) Cracks, fissure, or chipping	Visual inspection
Functional Inspection	3) Mating/Unmating: Corresponding tabs fit into each other to allow them to lock. The unlocking leg can be smoothly pulled out while being depressed.	By hand

Each package is classified by date code and inspected for appearance for AQL 40% based on Level II (MIL-STD-105) standards, and then inspected for the functions of 5 pieces in each package. The lot may be accepted if all of them successfully pass the inspection.

3. Cautions for Products Handling and Crimping Operation :

Any crimping of contacts must be performed by using appropriate AMP tools according to the applicable Instruction Sheet and specification.

The part numbers and date code (such as the above example, 89402) should be recorded for future reference.

3.1 Storage and Transportation

- 1) Avoid carrying unpacked products. Carry and store in the containers.
- 2) Carrying reels by only one of flanges can damage the reel and make it unusable, or unloadable onto crimping machines. Be sure to carry a reel by holding both flanges as shown.

Do not carry reels horizontally holding only one flange

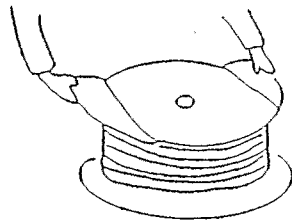

Recommended method

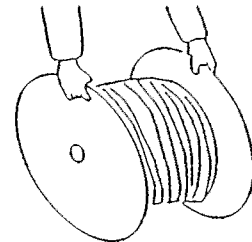

- 3) Do not place reels in places with high humidity. Reels should be stored in a relatively dry, clean room indoors, place where they will not be exposed to direct sunlight, and maintained at normal temperature and humidity. (5 to 35 °C and 45 to 85% relative humidity.)
- 4) If reels are temporarily taken off the crimping machine when suspending operation, tie the reel end to the flange with string to prevent the reel from loosening.

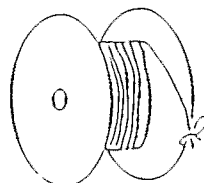

Tie reel ends to prevent them from loosening.

3.2 Crimping Procedure Control

Procedure control should be documented referring to the following documents to develop a "procedure instruction manual".

Contact Extraction Tool	IS-288
Application Specification	114-5094
Automatic Machine Manual	CM-022J
Applicator Inspection	AI-8025

Take the following precautions.

- (1) When stripping the wire, care must be taken not to nick, cut or scrape the conductors.

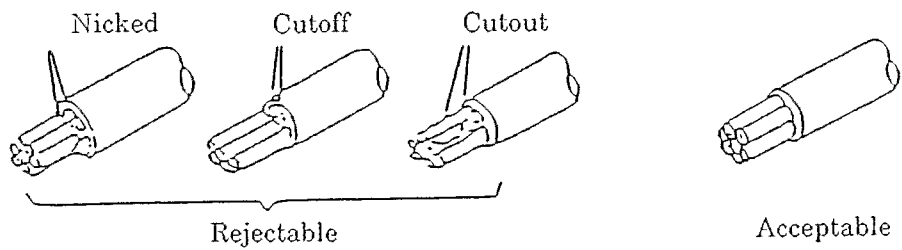

- (2) Wire insulation stripping length :

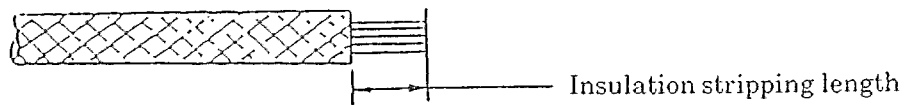

The length of the wire barrel of the contact used + 0.5 to 1.0 mm is applicable.

- (3) Crimp cross-sectional diagram

Note : The crimping height tolerance depends on the terminal.

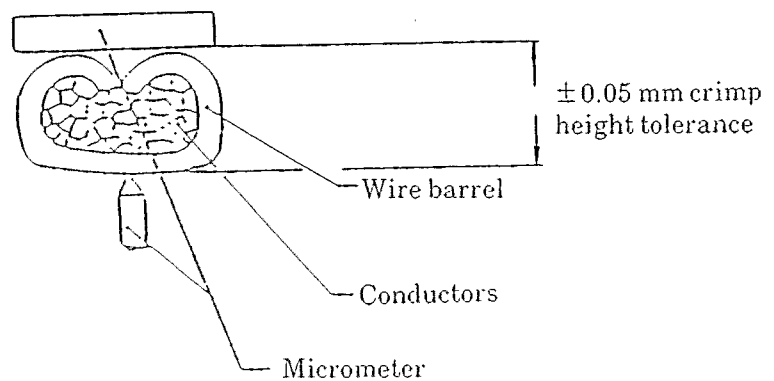

- (4) Micrometer (For measuring the crimp height)

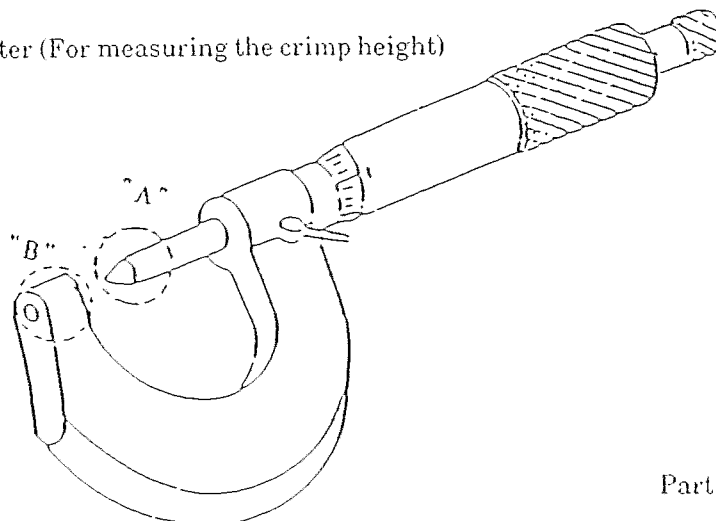

3.2.1 Inspection of Wire-Crimped Contact:

(Refer to 114-5094, Application Specification, Crimping .040 Series Contacts for details.)

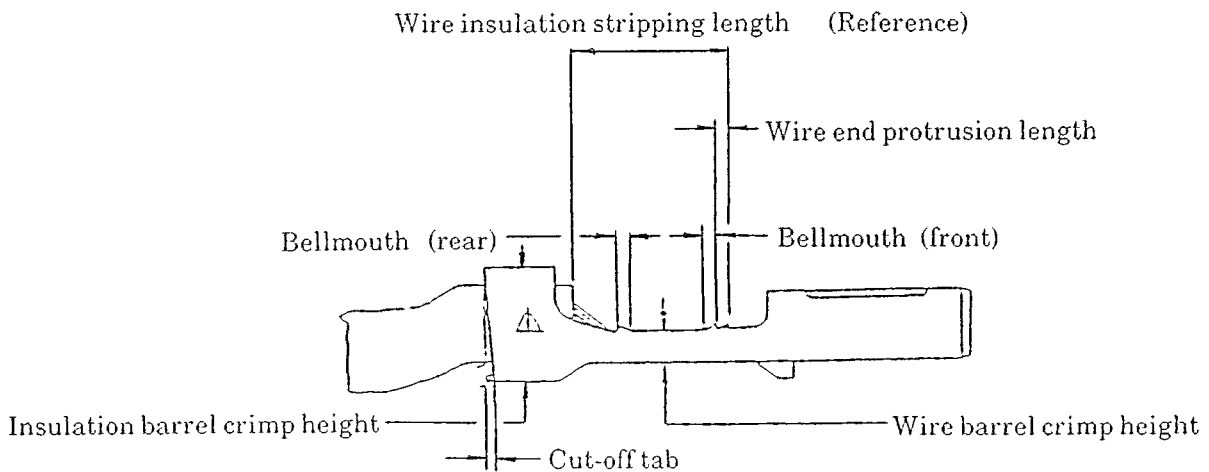
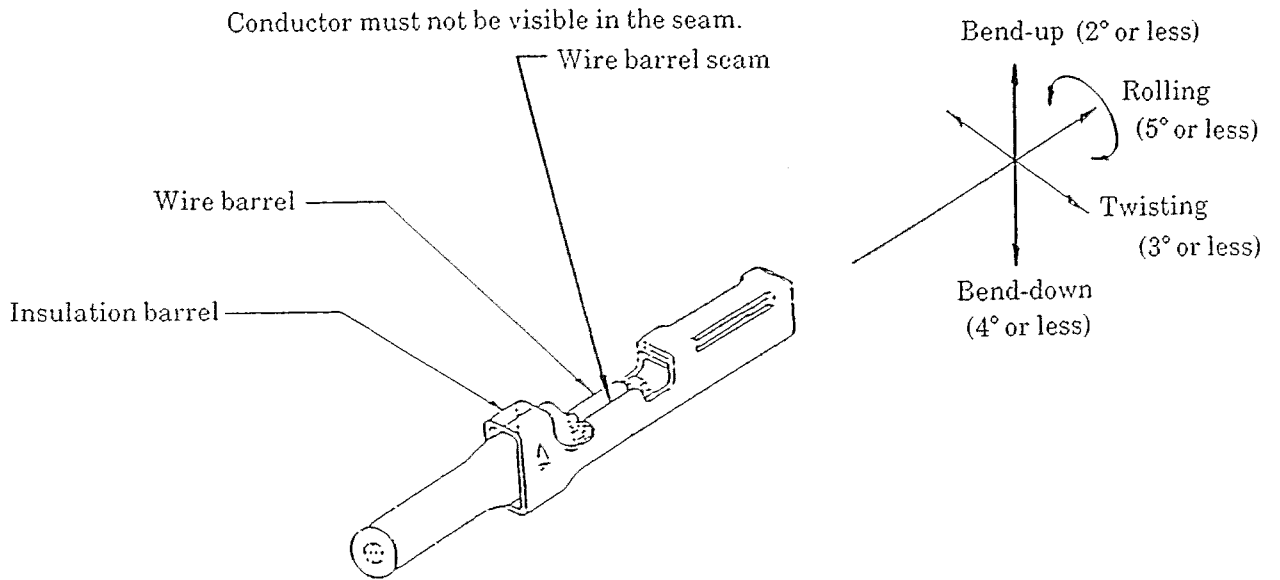

3.2.2 Crimping data (Applicator numbers and dimensions are listed below. Refer to figures in the following table whenever you start operation.)

0.04 Series Receptacle

Contact Part No. (Strip form)	Wire Type (Nominal)	Applicator Part No.	Wire Barrel Crimp			Insulation barrel crimp			Crimp Tensile strength (kg)
			Width (mm)	Height ± 0.05 mm (Fig. 1 ⑧)	Disk	Width (mm)	Height (mm) (Fig. 1 ⑨)	Disk (Ref.)	
173681	0.3	755830-2	1.57 F	0.92	B	1.78	13.7 \pm 0.1	4	6 Minimum
173716	0.5			1.02	A			5	9 Minimum

- Note:
1. Crimp tensile strength includes the strength with the support of the insulation.
 2. Applicable wire: Low voltage cables for automobiles, AV 0.3 to 0.5 mm²

3.3 Crimped Lead Inspection Prior to Harness Assembly

3.3.1 Inspection

We recommend that crimped products be inspected under the same conditions and observing the following table. Each product is an inspection unit. That is, either products successively manufactured during one adjustment cycle of a crimping machine, or products manufactured within one working day are assumed to be one lot.

Type of inspection	Timing	Inspection item
First-sight inspection	When applicator is setup for a specific wire for the first time.	Appearance and dimensions inspection (All items described below).
Lot inspection	When daily operation starts.	Same as above
	Any time during successive manufacturing processing.	Appearance (All items described below) and dimensions inspection (Section 3)

Item	Inspection Standards and Methods	Measuring Methods
Appearance Inspection	1. Wire conductors not gripped in wire crimp or cut conductor(s)	Visual inspection
	2. Inspection crimp form (Bellmouth) (Wire-end protrusion)	Visual inspection
	3. Flash edges of formed contact bottom	Visual inspection
	4. Insulation not gripped in insulation barrel	Visual inspection
	5. Inadequate forming of contact area of contact	Visual inspection
	6. Locking lever falling	Visual inspection
Dimensions Inspection	1. Cut-off tab dimension: less than 0.25 mm	Calipers
	2. Terminal deformation (bending, rolling, and twisting)	Magnifying glass
	3. Crimp height	Micrometer
	4. Front and rear Bellmouth for core crimp: front: 0 - 0.4 mm, rear: 0.15 - 0.65 mm	Vernier Calipers
	5. Locking lever height: more than 3.5 mm	Vernier Calipers

*Vernier calipers or other equivalent measuring instruments

3.3.2 Storage

- a) Storage must be done in a dry, clean place. Products must be covered if stored for more than one day.
- b) If units are bundled, one bundle must not have more than 100 units in it.
- c) Stacking large amounts of crimped wire leads can entangle the contacts and or cause deformation by the weight. These will cause defective contacts.
- d) Be careful that the terminals do not become intertwined when separating units from the bundle.

4. Harness Assembly Operation

4.1 Contact Loading into Housing

- (1) Before loading contacts into the housing, verify that there are no incomplete crimps and then place the contact with the locking lever facing upward as shown in Fig. 1 and insert the contact straight until it stops at the end of housing cavity.

If the contact is not easily seated in housing, do not force it, but make sure that it is going in the right direction.

Terminals forced in backwards can accidentally scrape the housing lance off.

- (2) Verify that the terminal has been firmly locked to the housing lance. If the crimp is located at the center of the retainer during contact mounting as shown in Fig. 2, contact locking is not engaged rightly, causing the contact to slip out. Push the contact into the lance as shown in Fig. 3. Locking it to the housing lance correctly will make a clicking sound.

After inserting the contact in place, check it by pulling the wire backward. Whenever the contact has to be removed for remounting, use the specified pulling tools.

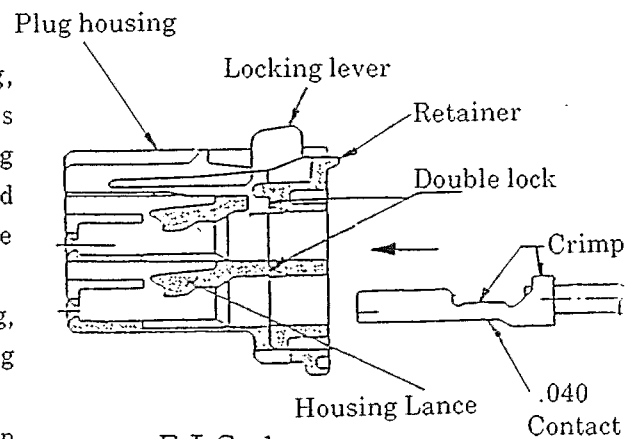

FIG 1

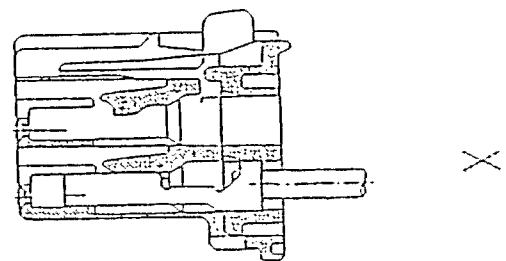

Fig. 2 Contact is not locked.

4.2 Double Lock Ratchet:

- (1) A double lock ratchet is used to reinforce contact support. The insulation barrel is supported at the retainer type double lock area. See Fig. 4.
- (2) If contacts are not mounted correctly inside the housing, double lock may not completely lock or effectively lock. See Figs. 2 and 6.
- (3) Verify that the double lock is firmly locked. When completing and verifying steps (1) and (2) above, press the retainer press area. The retainer moves downward and the ratchet clicks to be released. Make sure it is locked by lightly pulling the wire outward. The conditions shown in Figs. 4 and 5 will be seen if the retainer behaves correctly.

If any contacts are not completely fixed, the retainer does not work properly resulting in the condition shown in Fig. 6, in which the retainer is effective only on one side and the ratchet teeth are lifted on one side. If this happens, remount the contact in the correct position using a removing jig.

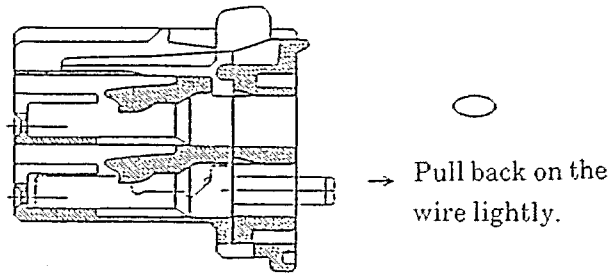

Fig. 3 When contact is correctly locked.

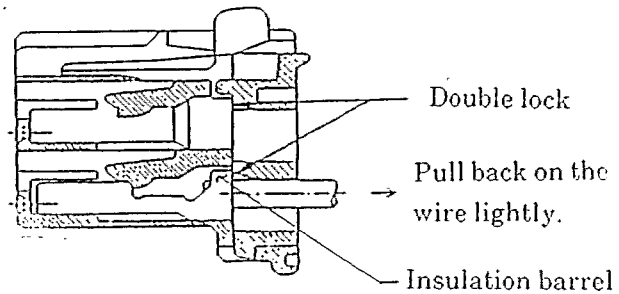

Fig. 4 When double lock is completed

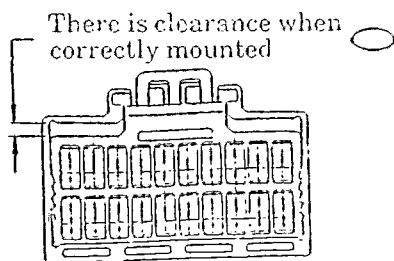

Fig. 5 When double lock is completed

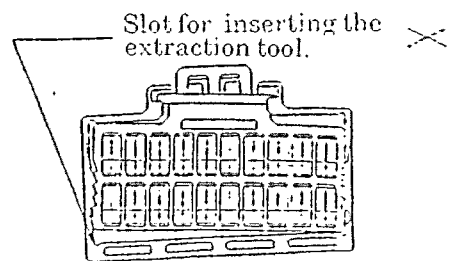
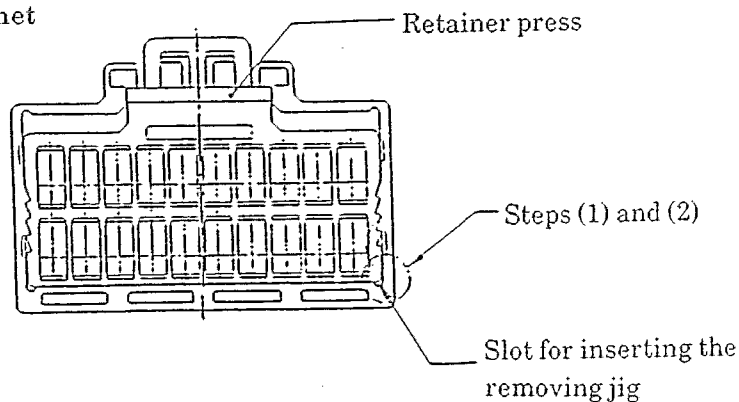

Fig. 6 When detent locking is incomplete (Ratchet teeth are effective on only one side).

4.3 Extracting Contacts from the Housing

This jig is used to pull .040 series ML C/I/O connector MK-II+ contacts out of the plug housings.

4.3.1 Unlocking the double lock ratchet



Procedures

Unlock the detent lock

(1) Insert the jig into the insertion slot.

(2) Release the ratchet teeth by turning the jig in the direction of the arrow so that the housing wall bends to allow you to lift the retainer press area upward. Repeat the same procedure for the other side as well.

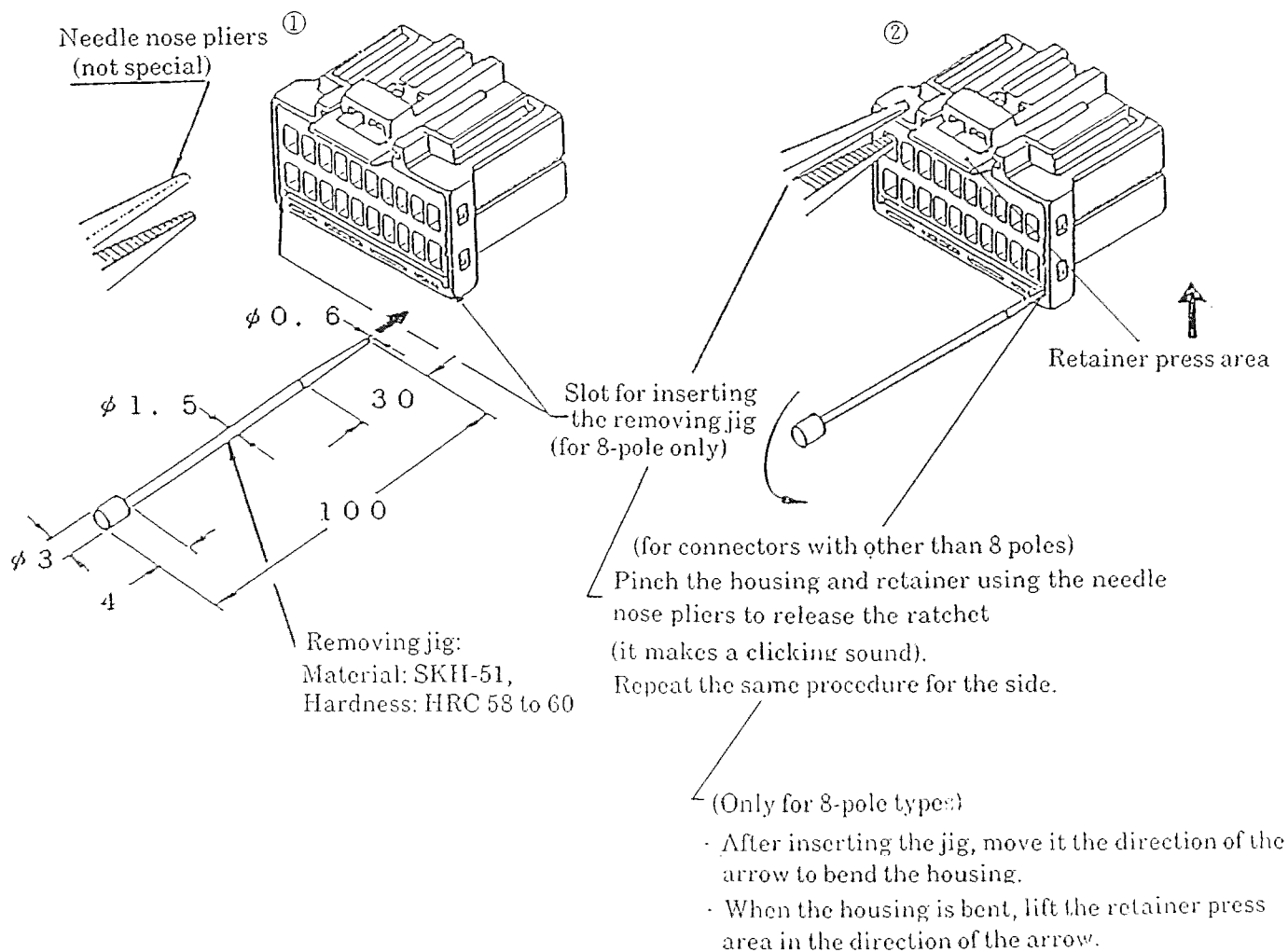

Note: Bending the wall excessively may damage it.

4.3.2 Extracting Contacts

Remove contacts by inserting the jig from the connector fitting side to lift up the connector housing lance.

- ① Depress the contact in the direction of the arrow.
- ② Insert jig.
- ③ Lift up the lance.
- ④ Remove the contact.

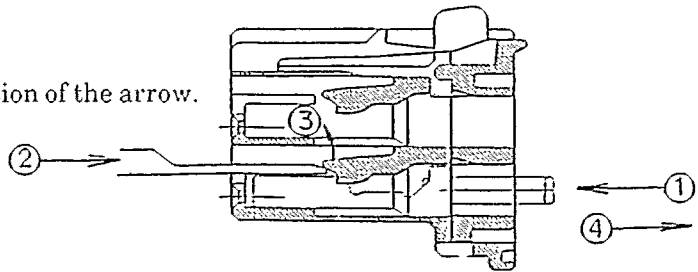

Note: Do not insert the removing jig into the contacting area of receptacle contacts (in order to prevent the contact leaf from deforming).

4.4 Harness Product Control

4.4.1 Inspection

While total product inspection is required based on an inspection unit of one completed harness product, the following requirements must also be satisfied.

- a. Corresponding tab or its equivalent should be used as a probe to check the entire circuit within the connector.
- b. Inserting an inspection probe into the terminal is strictly prohibited, since it may cause deformation of the fitting.

4.4.2 Storage

- a) Storage must be done in a dry, clean area. The product should not be stored without covering for more than one day.

4.4.3 Shipment and transportation

- a) Use appropriate packaging cartons to avoid dust or moisture, and handle the cartons with care.
- b) Cartons must have the necessary information on them.

5. Mounting On Vehicles

5.1 Acceptance Inspection

A minimum of the following points must be checked.

- a) Bundling location of each wire protruding out of the housing (more than 20 mm for unbent wire, and more than 10 mm for bent wire).
- b) Acceptability of contact mounting to the housing
- c) Contact cracks, defects, discoloring, and deformation, etc.
- d) Housing cracks, defects and discoloration, etc.
- e) Confirmation and removal of defective parts.

5.2 Mounting Operation Control

- a) Mating action should be made straight along the mating axis. Then, confirm that the locking mechanism works correctly. When engaged correctly, a small clicking sound is heard. Pull the connector outward lightly after making fittings to make sure they are locked.
- b) Do not repeat mating / unmating connectors if not necessary.
- c) When the contact has to be pulled out of the housing during processing, use the specified removing jig and follow the instructions in section 5.
- d) When checking the circuit, use the corresponding tabs or their equivalent.
- e) Handle the harness with as much care as possible. Take the following precautions in handling.
 - i) Do not handle the harnesses roughly such as throwing them around.
 - ii) Do not draw the harness bundle dragging on the floor.
 - iii) Do not carry harnesses by the connectors. Carry them by holding the wires.
 - iv) Do not handle them in such a way that pulls on the wire and puts unnecessary force on the connectors.
- f) If connectors have to be removed, follow the instructions in paragraph 5.3.

5.3 Unmating Connectors

Hold the housing locking lever and press downward. While pressing downward, pull the connector straight out.

- Note: * Do not pull the connector by the wires.
* Pull the connector straight.