

HVS-1520S-W Series

15kV Class Splice for Extruded Dielectric (Poly/EPR) Power Cables:
Metallic Tape, Wire Shield, UniShield, or Lead Sheath Cables

ENERGY DIVISION

Suggested Installation Equipment (not supplied with kit)

- Cable preparation tools
- Tyco Electronics P63 cable preparation kit or cable manufacturer approved solvent
- Clean, lint-free cloths
- Non-conducting abrasive cloth, 120 grit or finer
- Electrician's tape
- Connector(s) and installation tools
- Tyco Electronics recommended torch

Safety Instructions

Warning: When installing electrical power system accessories, failure to follow applicable personal safety requirements and written installation instructions could result in fire or explosion and serious or fatal injuries.

To avoid risk of accidental fire or explosion when using gas torches, always check all connections for leaks before igniting the torch and follow the torch manufacturer's safety instructions.

To minimize any effect of fumes produced during installation, always provide good ventilation of confined work spaces.

As Tyco Electronics has no control over field conditions which influence product installation, it is understood that the user must take this into account and apply his own experience and expertise when installing product.

Kit Contents

The following items should be included in this kit:

- 1 Black stress control tube
- 1 Red insulating tube
- 1 Black/red dual wall tube
- 1 Green/Black wraparound re-jacketing tube
- 2 Wraparound channels
- 1 Channel clip
- 1 Copper braid
- 2 Roll springs
- 1 Installation instruction
- 2 Ground connectors
- 4 Strips copper tape
- 2 Angle-cut strips stress relief material
- Rolls copper mesh
- Long strips stress relief material
- Strips red sealant

Recommended Tyco Electronics Torches

Install heat-shrinkable cable accessories with a "clean burning" torch, i.e., a propane torch that does not deposit conductive contaminants on the product.

Clean burning torches include the Tyco Electronics FH-2629, FH-2649 (uses refillable propane cylinders) and FH-2618A (uses disposable cylinder).

Adjusting the Torch

Adjust regulator and torch as required to provide an overall 12- inch bushy flame. The FH-2629 will be all blue, the other torches will have a 3- to 4-inch yellow tip. Use the yellow tip for shrinking.

Regulator Pressure

FH-2618A	Full pressure
FH-2649	25 psig
FH-2629	15 psig

General Shrinking Instructions

- Apply outer 3- to 4-inch tip of the flame to heat-shrinkable material with a rapid brushing motion.
- Keep flame moving to avoid scorching.
- Unless otherwise instructed, start shrinking tube at center, working flame around all sides of the tube to apply uniform heat.

To determine if a tube has completely recovered, look for the following, especially on the back and underside of the tube:

1. Uniform wall thickness.
2. Conformance to substrate.
3. No flat spots or chill marks.
4. Visible sealant flow if the tube is coated.

Note: When installing multiple tubes, make sure that the surface of the last tube is still warm before positioning and shrinking the next tube. If installed tube has cooled, re-heat the entire surface.

1. Product selection.

Check kit selection with cable diameter dimensions in Table 1.

Note: Table is for 100% insulated cable. For 133% insulated cable, check actual cable dimensions.

2. Check ground braid.

Verify that ground braid(s) or bond wire have equivalent cross-section to cable metallic shield. Additional braid may be needed for lead sheath cables, or if external grounding or shield interrupting is required.

Tyco Electronics HVS-EG supplies ground braid, spring clamp and suggested modifications to make an external ground or shield interrupt.

Table 1

Kit	Nominal Cable Range	Maximum Jacket Diameter	Insulation Diameter Range	Maximum Connector Dimensions	
				Length	Diameter
HVS-1521S-W	#2-4/0 AWG	1.25 (32mm)	0.65-1.05 (17-27mm)	4.25 (108mm)	0.90 (23mm)
HVS-1522S-W	250-350 kcmil	1.50 (38mm)	0.90-1.30 (23-33mm)	5.50 (140mm)	1.15 (29mm)
HVS-1523S-W	500-750 kcmil*	1.85 (47mm)	1.10-1.60 (28-41mm)	8.00 (203mm)	1.60 (41mm)
HVS-1524S-W	750-1000 kcmil	2.10 (53mm)	1.25-1.80 (32-46mm)	8.00 (203mm)	1.85 (47mm)
HVS-1525S-W	1250-2000 kcmil	2.80 (71mm)	1.60-2.50 (41-64mm)	11.00 (279mm)	2.40 (60mm)

* For 750 kcmil 133% insulation level, use HVS-1524S-W

3. Prepare cables.

Choose the cable type (Choice 1-3) and use the dimensions shown in Table 2 to prepare the cables.

Table 2

Kit	Jacket Cutback A	Metallic shield Cutback		semi-con Cutback C
		B		
HVS-1521S-W	9-1/2" (240mm)	8"	(203mm)	4-1/2" (115mm)
HVS-1522S-W	10-1/2" (265mm)	9"	(230mm)	5" (125mm)
HVS-1523S-W	11-1/2" (290mm)	10"	(255mm)	6-1/2" (165mm)
HVS-1524S-W	12" (305mm)	10-1/2"	(265mm)	6-1/2" (165mm)
HVS-1525S-W	14" (355mm)	12"	(305mm)	8" (203mm)

CHOICE 1

If Metallic Tape Shield, or Lead Sheath Cable

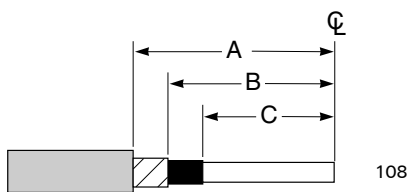

CHOICE 2

If Drain Wire Shield Cable

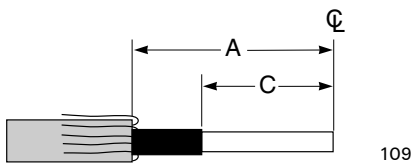

CHOICE 3

If UniShield Cable

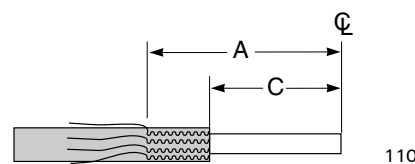

4. Remove insulation.

Refer to Table 3 and cut back the insulation as shown.

Table 3

Kit	Maximum Connector Dimensions		Expansion Gap "X"
	Length	Diameter	
HVS-1521S-W	4-1/4" (108mm)	1.00" (25mm)	1/4" (5mm)
HVS-1522S-W	5-1/2" (140mm)	1.35" (34mm)	1/4" (5mm)
HVS-1523S-W	8" (203mm)	1.60" (41mm)	1/2" (10mm)
HVS-1524S-W	8" (203mm)	1.85" (47mm)	1/2" (10mm)
HVS-1525S-W	11" (279mm)	2.40" (60mm)	1/2" (10mm)

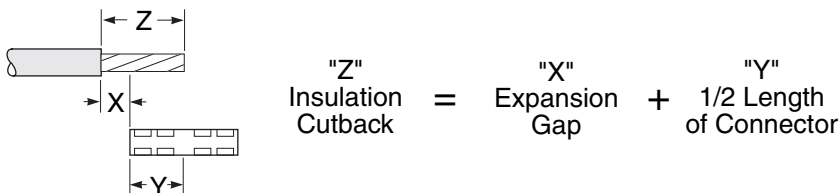

5. Abrade insulation.

Abrade the insulation, as necessary to remove imbedded semi-con, and clean.

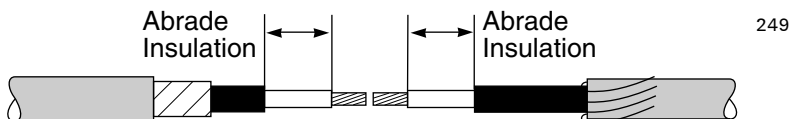

6. Clean cable jackets.

Clean cable jackets for the length of the tubes.

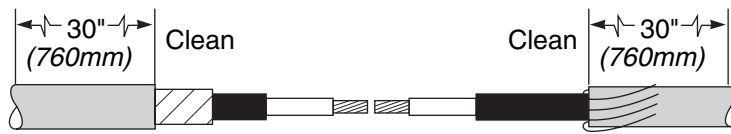

271

7. Place nested tubes over cable as shown.

Protect tubes from end of conductor as they are placed over cable end.

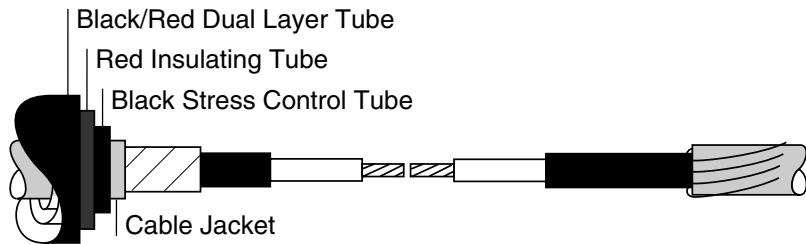

602

8. Install connector.

After installation, deburr connector.

Using an approved solvent, clean the insulation as shown.

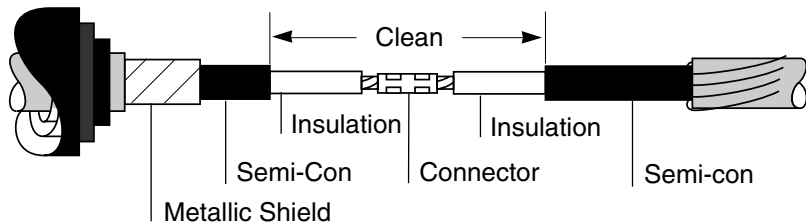

603

9. Apply SRM over connector.

Remove backing from one side of the *long strip* of Stress Relief Material (sRM). Roll the SRM and remaining backing strip into a convenient size. Remove the remaining backing strip and tightly wrap the SRM around the connector and exposed conductor. Be sure to fill the gaps and low spots around the connector.

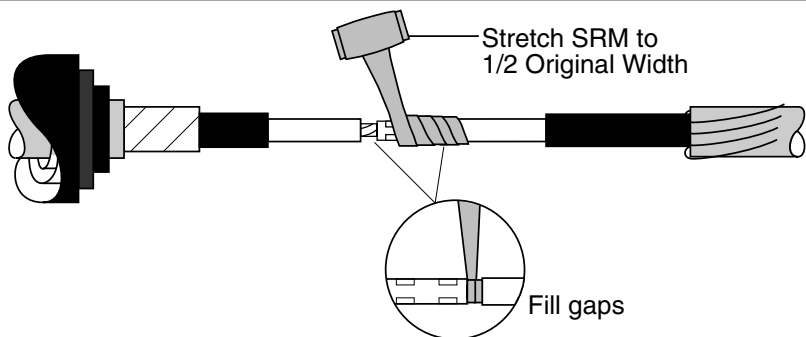

604

Continue to wrap SRM onto the solvent cleaned insulation as shown.

Note: If connector diameter is larger than insulation diameter, apply two half-lapped layers of SRM over the entire connector. Discard any excess SRM (long strips).

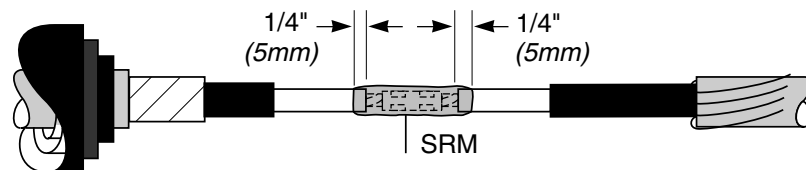

605

10. Apply SRM at semi-con cutback.

Remove backings from the *short angle-cut piece* of SRM. Place tip of SRM at semi-con cutback and tightly wrap to fill semi-con step. Overlap semi-con and insulation as shown. Taper SRM down to meet insulation.

Note: If using Unishield cable, apply SRM as shown to fill conductive jacket step.

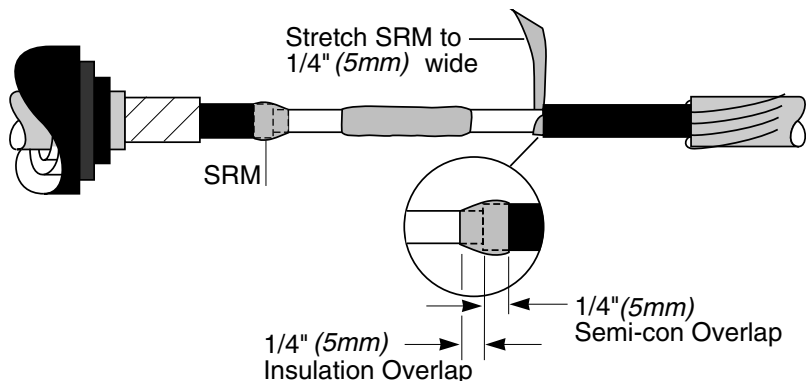

606

11. Apply Silicone Grease.

Snip open the end of the silicone grease tube and apply a thin film of grease on the SRM over the connector and semi-con steps.

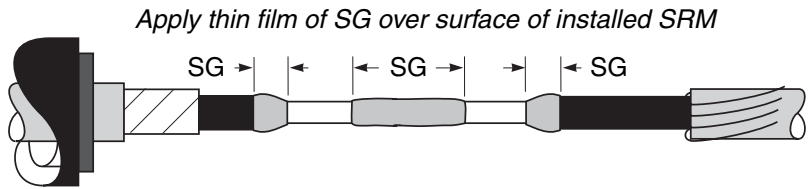

113a

12. Position black stress control tube; shrink in place.

Center the tube over the splice. Begin shrinking at the center (1) of the tube, working the torch around all sides of the tube. After the center portion shrinks, work towards one end (2), then to the opposite end (3).

Note: Do not point the flame at the cable semi-con.

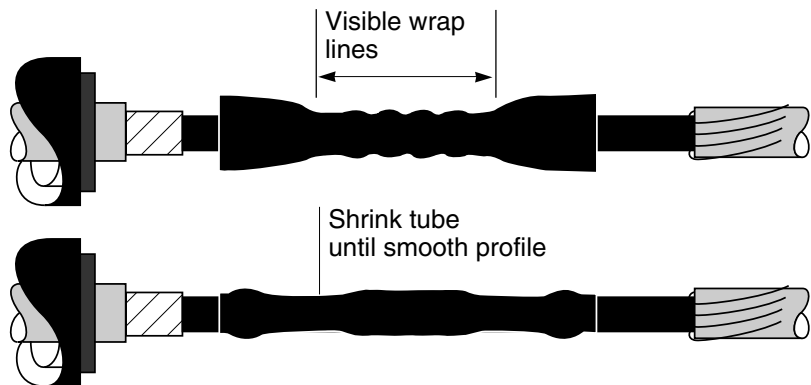
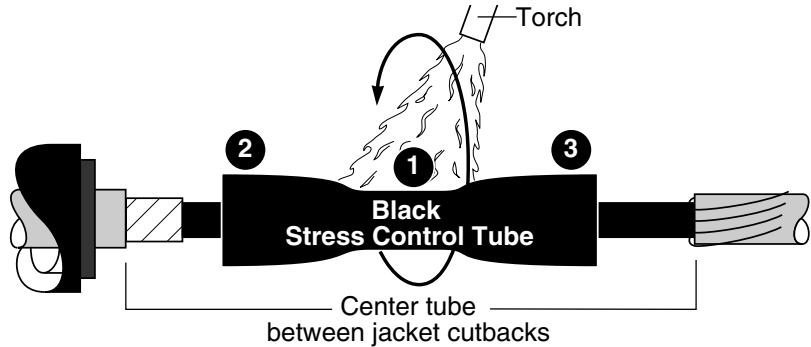

607

The rings from the SRM wraps may be visible as the tubing is shrunk.

Post heat the connector area until the tube surface is smooth and the under-lying SRM wraps are no longer visible.

13. Position red insulating tube; shrink in place.

Center the tube over the black stress control tube. Shrink in place using the same method as in step 12.

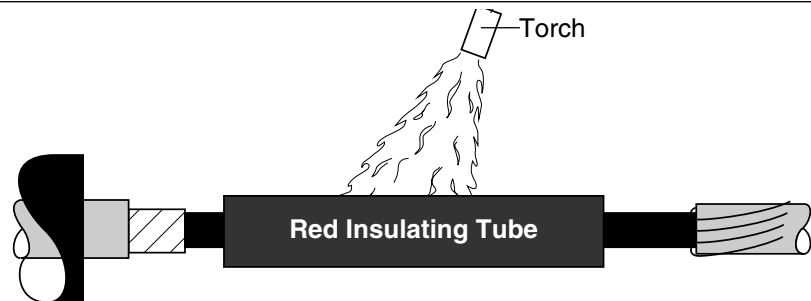

608

14. Apply red sealant.

Remove backing from red sealant. Using light tension, wrap sealant over the cable, butted against the tubes as shown. Build the sealant to the level of the red insulating tube.

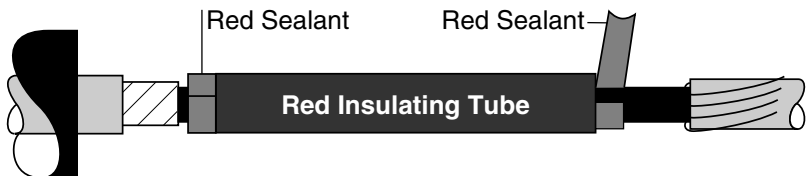

609

15. Position black/red dual layer tube; shrink in place.

Center tube over the red insulating tube. Shrink in place using the same method as in Step 12.



106

Note: If External Grounding or Shield Interrupting

Refer to Tyco Electronics HVS-EG, "Guide for External Grounding and Shield Interrupting of Power Cable Splices" for modifications to these instructions.

16. Install ground.

Choose the appropriate cable type (Choice 1-3) and follow the directions given.

CHOICE 1

If Drain Wire or Unshield Cable

Pigtail the shield wires on each side. Crimp the ground braid onto one pigtail with the connector provided.

Lay braid across splice tubes and attach to pigtail on the other side. Cut off excess braid and trim pig-tailed wires.

Discard spring clamps and foil tape.

Go to step 17.

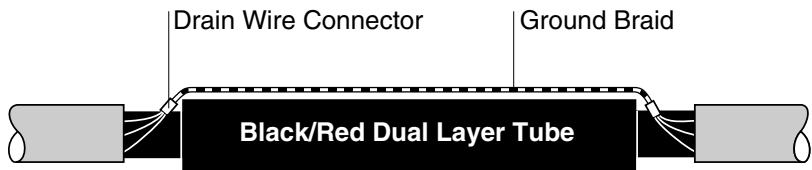

610

CHOICE 2

If Metallic Tape shield Cable

(1) Flare one end of the ground braid and place it onto the metallic tape butted up to the installed splice tubes. (2) Attach the braid to the shield by placing two wraps of the spring clamp over the braid. (3) Fold the braid back over the spring clamp wraps. Continue to wrap the remaining clamp over the braid. Tighten clamp by twisting it in the direction it is wrapped and secure with copper foil tape provided.

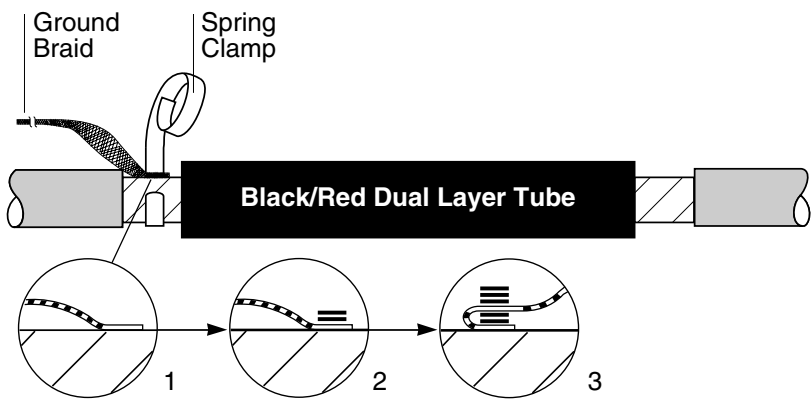

611

(4) Lay the braid across the splice tube and onto the exposed tape shield on the other side. (5) Make two wraps of the clamp over the braid. (6) Fold the braid back toward the splice and finish wrapping the clamp. Tighten and secure. Cut off excess braid.

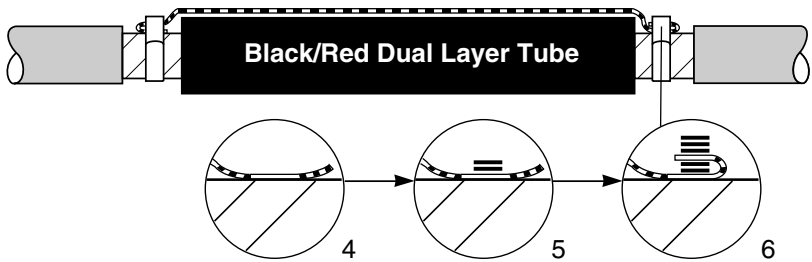

Discard connectors.

Go to step 17.

612

CHOICE 3

If Lead Sheath Cable

Solder ground braid(s) or bonding wire on to lead sheath. Deburr connection. Discard spring clamps, connectors, and foil tape.

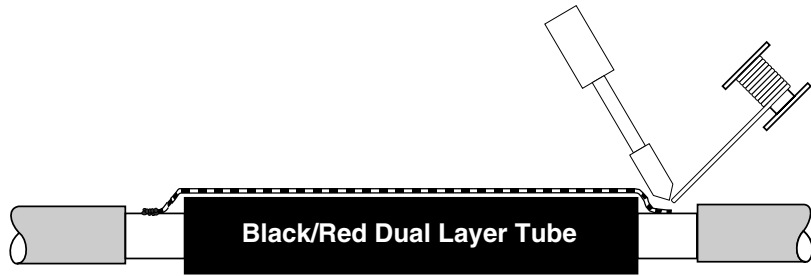

613

17. Install the shielding mesh.

Wrap a half-lapped layer of the mesh across the entire splice and tie-off.

Abrade and solvent clean cable jackets as shown to provide an oil-free surface.

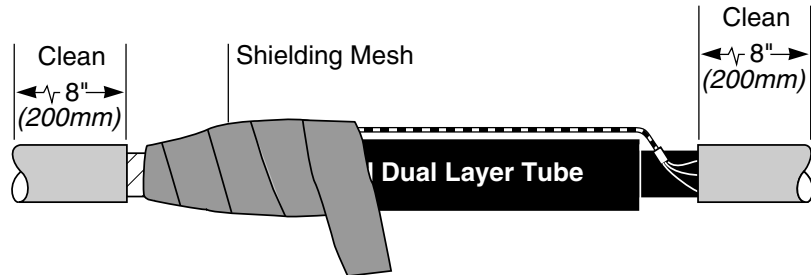

614

18. Apply red sealant.

Remove release paper from red sealant and place one full wrap at cable jacket cutbacks as shown.

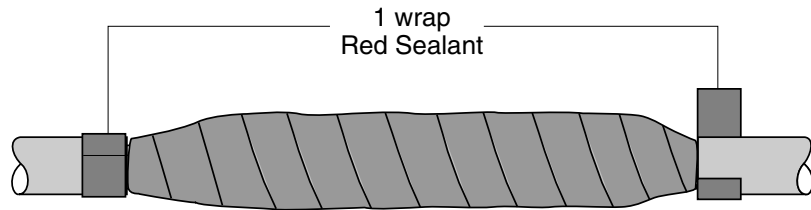

614a

19. Position wraparound sleeve.

Remove or tape over all sharp points to prevent puncture of wraparound sleeve. Remove backing from the wraparound sealing sleeve and center sleeve over splice. Slide metal retention clip onto the butted rails.

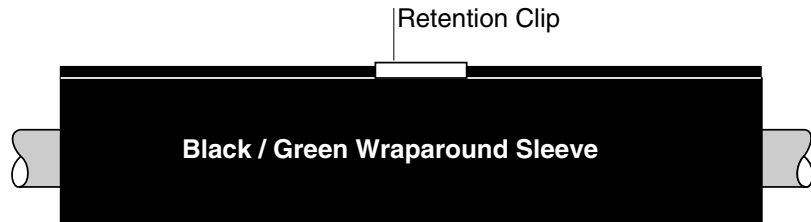

614b

20. Install channels.

Connect the channels by overlapping the retention clip as shown at right.

Note: Channels must overlap sleeve edge by 1/4 inch (5mm) minimum.

If channels slide on easily go to step 21. If channel fit seems tight, continue with next paragraph.

As shown in illustration A, make sure flap is not pinched between the rails. Push the sleeve up from the bottom and down from the top while sliding on channel as shown in illustration B. The idea is to flatten the rails together to prevent the channels from binding.

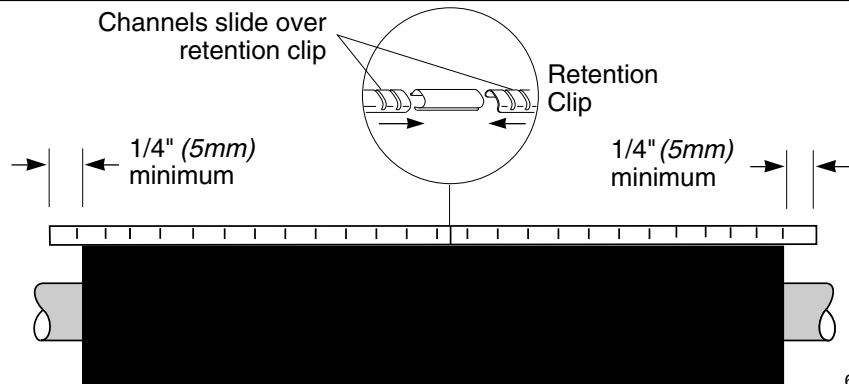

614c

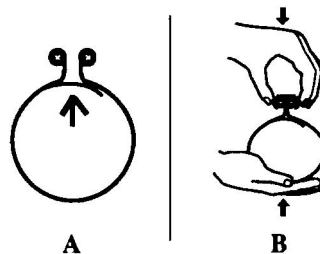

22. Shrink the wraparound sleeve.

Preheat evenly along both sides of the rail/channel area until this area begins to shrink. To achieve uniform heating, move the flame back and forth from one side of the channel to the other as shown in illustration "A" while moving flame along the entire length of the channel as shown in illustration "B" until the sleeve starts to shrink. This technique will assure a properly preheated rail and channel area.

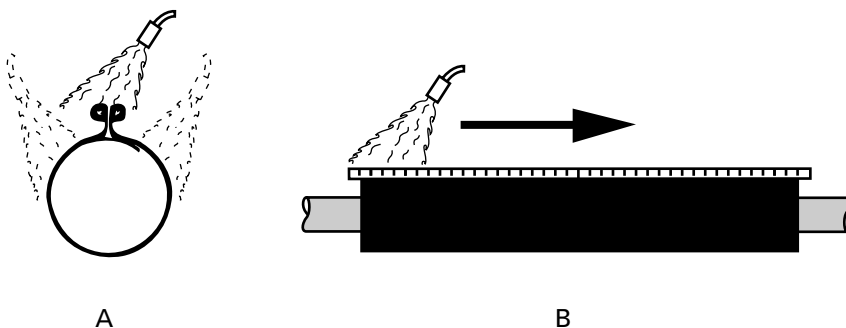

Begin shrinking at the center of the sleeve and work toward each end. Apply heat until the sleeve is fully shrunk and the heat-sensitive green paint is completely converted to black. Continue heating the rail/channel area for another 5 seconds per foot. A white line should be visible in the channel gaps indicating sufficient heating.

Note: Green heat-sensitive paint will turn black as sleeve shrinks in place.

This completes the splice.

Note: Allow to cool before moving or placing in service.

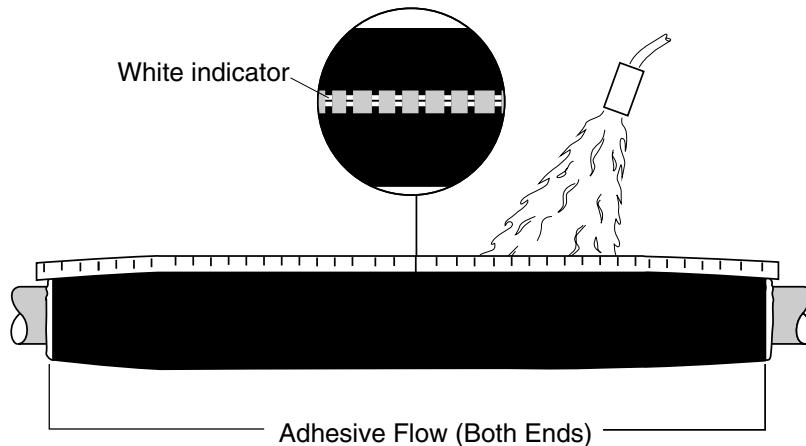

614d

The Information contained in these installation instructions is for use only by installers trained to make electrical power installations and is intended to describe the correct method of installation for this product. However, Tyco Electronics has no control over the field conditions which influence product installation. It is the user's responsibility to determine the suitability of the installation method in the user's field conditions. Tyco Electronics' only obligations are those in Tyco Electronics' standard Conditions of Sale for this product and in no case will Tyco Electronics be liable for any other incidental, indirect or consequential damages arising from the use or misuse of the products. Raychem is a trade mark of Tyco Electronics Corporation. * UniShield is a registered trademark of BICC General Cable Industries, Inc.