

## HVS-3-820S 8kV Class

Splice for 3/C Extruded Dielectric  
(Poly/EPR) Power Cable:  
Metallic Tape, Wire Shield,  
or UniShield® Cable

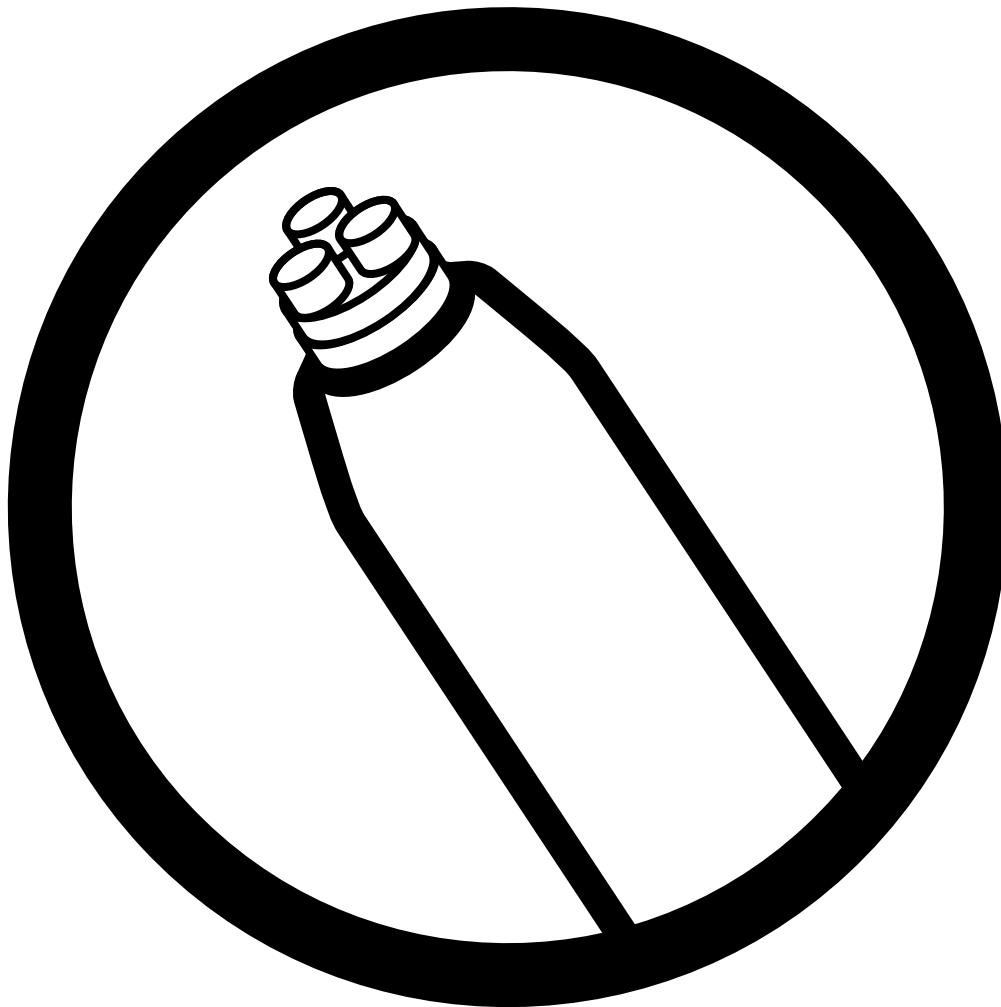

UniShield is a registered trademark of Cablec Corporation.

## General Instructions

### Suggested Installation Equipment (not supplied with kit)

- |   |   |   |
|---|---|---|
| <ul style="list-style-type: none"> <li>• Cable preparation tools</li> <li>• Raychem P42 cable preparation kit or cable manufacturer approved solvent</li> </ul> | <ul style="list-style-type: none"> <li>• Clean, lint-free cloths</li> <li>• Non-conducting abrasive cloth, 120 grit or finer</li> <li>• Electrician's tape</li> </ul> | <ul style="list-style-type: none"> <li>• Connector(s) and installation tools</li> <li>• Raychem recommended torch</li> <li>• Solder and soldering iron</li> </ul> |
|---|---|---|

### Recommended Raychem Torches

Install heat-shrinkable cable accessories with a "clean burning" torch, i.e., a propane torch that does not deposit conductive contaminants on the product.	Clean burning torches include the Raychem FH-2609, FH-2629 (uses refillable propane cylinders) and FH-2616A1 (uses disposable cylinder).
---	--

### Safety Instructions

<p><b>Warning:</b> When installing electrical power system accessories, failure to follow applicable personal safety requirements and written installation instructions could result in fire or explosion and serious or fatal injuries.</p>	<p>To avoid risk of accidental fire or explosion when using gas torches, always check all connections for leaks before igniting the torch and follow the torch manufacturer's safety instructions.</p>	<p>To minimize any effect of fumes produced during installation, always provide good ventilation of confined work spaces.</p>
--	--	---

### Adjusting the Torch

Adjust regulator and torch as required to provide an overall 12- inch bushy flame. The FH-2629 will be all blue, the other torches will have a 3- to 4-inch yellow tip. Use the yellow tip for shrinking.
---

### Regulator Pressure

FH-2616A1	Full pressure
FH-2609	5 psig
FH-2629	15 psig

### General Shrinking Instructions

<ul style="list-style-type: none"> <li>• Apply outer 3- to 4-inch tip of the flame to heat-shrinkable material with a rapid brushing motion.</li> <li>• Keep flame moving to avoid scorching.</li> <li>• Unless otherwise instructed, start shrinking tube at center, working flame around all sides of the tube to apply uniform heat.</li> </ul>	<p>To determine if a tube has completely recovered, look for the following, especially on the back and underside of the tube:</p> <ol style="list-style-type: none"> <li>1. Uniform wall thickness.</li> <li>2. Conformance to substrate.</li> <li>3. No flat spots or chill marks.</li> <li>4. Visible sealant flow if the tube is coated.</li> </ol>	<p><b>Note:</b> When installing multiple tubes, make sure that the surface of the last tube is still warm before positioning and shrinking the next tube. If installed tube has cooled, re-heat the entire surface.</p>
--	--	---

## Installation Instructions

### 1. Product selection.

Check kit selection with cable diameter dimensions in Table 1.

\*If using 5/8kV (115 mils) cable use 8kV selection.

### 2. Check ground braid.

Verify that ground braid(s) or bond wire have equivalent cross-section to cable metallic shield. Additional braid may be needed for LC shield, lead sheath cables, or if external grounding or shield interrupting is required.

Raychem HVS-EG supplies ground braid, spring clamp and suggested modifications to make an external ground or shield interrupt.

Table 1 Kit	5kV	8kV	Minimum Jacket Diameter	Insulation Diameter Range	Maximum Connector Dimensions	
	Nominal Cable Range	Nominal Cable Range			Length	Diameter
<b>Dimensions in inches</b>						
HVS-3-821S	#6-2/0 AWG*	#6-#2 AWG	0.90	0.35-0.65	3.0	0.50
HVS-3-822S	3/0-300 kcmil*	#1-4/0 AWG	1.30	0.55-0.90	4.25	0.75
HVS-3-823S	350-750 kcmil*	250-350 kcmil	1.30	0.80-1.25	6.0	1.10
HVS-3-824S	750-1500 kcmil*	500-750 kcmil	1.55	1.00-1.60	8.0	1.45
HVS-3-825S		750-1000 kcmil	1.55	1.30-2.25	8.0	1.85
<b>Dimensions in millimeters</b>						
HVS-3-821S	#6-2/0 AWG*	#6-#2 AWG	23	9-17	76	13
HVS-3-822S	3/0-300 kcmil*	#1-4/0 AWG	33	14-23	108	19
HVS-3-823S	350-750 kcmil*	250-350 kcmil	33	20-32	152	28
HVS-3-824S	750-1500 kcmil*	500-750 kcmil	39	25-41	203	37
HVS-3-825S		750-1000 kcmil	39	33-57	203	47

## 3. Prepare cables.

Choose the cable type (Choice 1-3) and use the dimensions shown in Table 2 to prepare the cables.

**Table 2**

Kit	Jacket Cutbacks		Metallic Shield Cutback/ Wire Pullback		Semi-con Cutback	
	A1	A2	B	C	B	C
HVS-3-821S	20" (508mm)	10" (254mm)	6" (150mm)	3-1/4" (80mm)	6" (150mm)	3-1/4" (80mm)
HVS-3-822S	22-1/2" (572mm)	11-1/2" (292mm)	7" (180mm)	4" (100mm)	7" (180mm)	4" (100mm)
HVS-3-823S	26-1/2" (673mm)	12-1/2" (318mm)	8" (200mm)	5" (125mm)	8" (200mm)	5" (125mm)
HVS-3-824S	30-1/2" (775mm)	15" (381mm)	9-1/2" (240mm)	6" (150mm)	9-1/2" (240mm)	6" (150mm)
HVS-3-825S	32" (813mm)	15-1/2" (394mm)	10" (250mm)	6" (150mm)	10" (250mm)	6" (150mm)

### CHOICE 1

#### If Metallic Tape Shield Cable

Refer to Table 2 and prepare the cables as shown. Remove any fillers to the jacket cutback. Bend back the grounding conductor(s) over the jacket as shown.

**Go to Step 4, page 4.**

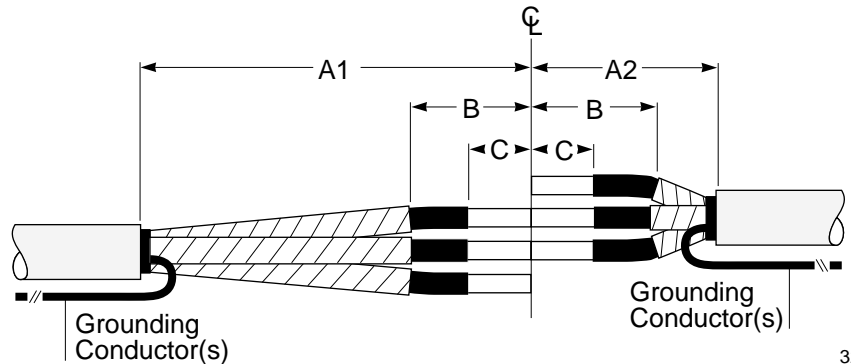

324

### CHOICE 2

#### If Drain Wire Shield Cable

Refer to Table 2 and prepare the cables as shown. Remove any fillers to the jacket cutback. Pull drain wires back to Dimension B and temporarily tape over ends as shown. Bend back the grounding conductor(s) over the jacket as shown.

**Go to Step 4, page 4.**

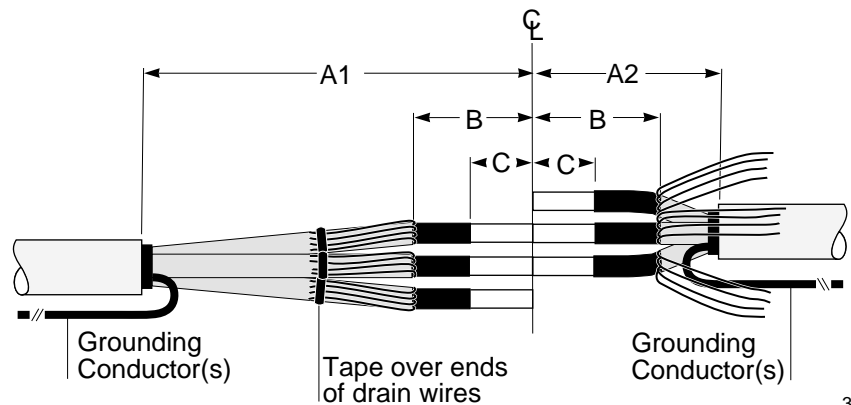

325

### CHOICE 3

#### If UniShield Cable

Refer to Table 2 and prepare the cables as shown. Remove any fillers to the jacket cutback. Pull drain wires back to Dimension B and temporarily tape over ends as shown. Bend back the grounding conductor(s) over the jacket as shown.

**Go to Step 4, page 4.**

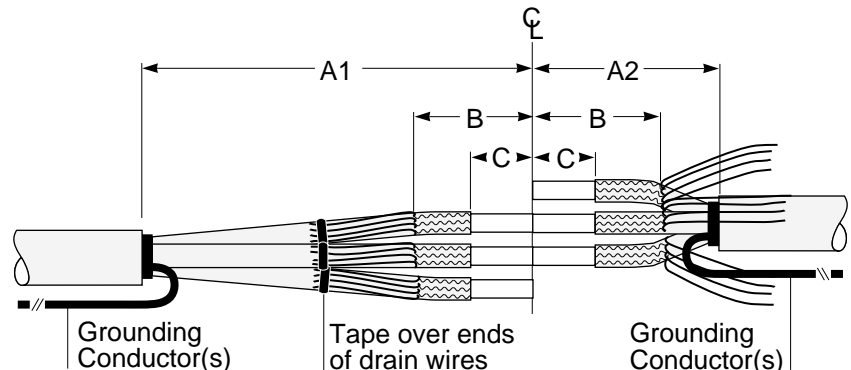

326

## Installation Instructions

### 4. Remove insulation.

Refer to Table 3 and Figure 1; cutback insulation as shown.

**Table 3**

Kit	Maximum Connector Dimensions		Expansion Gap "X"
	Length	Diameter	
HVS-3-821S	3.0" (76mm)	0.50" (13mm)	1/4" (5mm)
HVS-3-822S	4.25" (108mm)	0.75" (19mm)	1/4" (5mm)
HVS-3-823S	6.0" (152mm)	1.10" (28mm)	1/2" (10mm)
HVS-3-824S	8.0" (203mm)	1.45" (37mm)	1/2" (10mm)
HVS-3-825S	8.0" (203mm)	1.85" (47mm)	1/2" (10mm)

**Figure 1: Insulation Cutback**

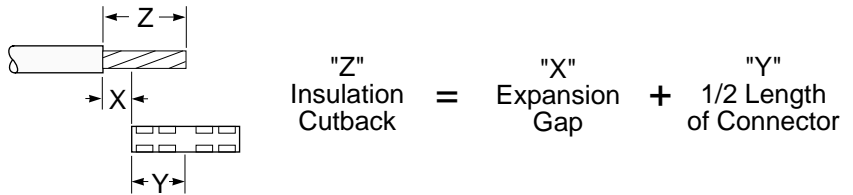

400

### 5. Abrade insulation.

Abrade the insulation, if necessary, to remove imbedded semi-con and clean as shown.

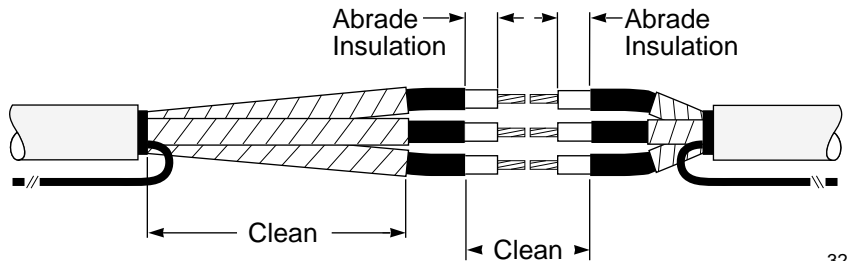

327

### 6. Place tubes over phases.

Place one black/red dual layer tube over each phase as shown.

Protect tubes from end of conductor as they are placed over cable end.

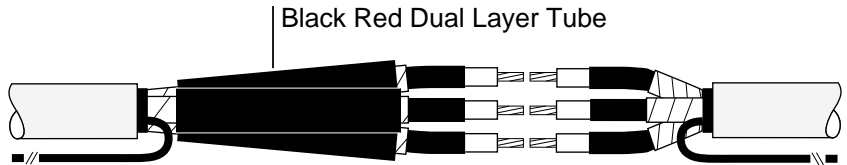

328

### 7. Install connector.

After installation, deburr connector.

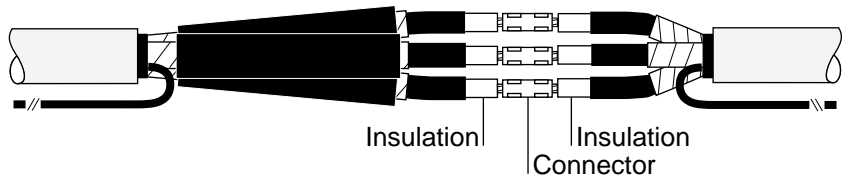

329

## 8. Apply SRM over connector.

**Complete Steps 8-11 working on one phase at a time.**

Clean connector area and insulation, as shown, using an oil-free solvent.

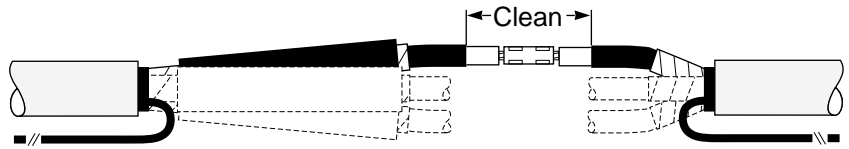

330

Remove backing from one side of the *long strip* of Stress Relief Material (SRM). Roll the SRM and remaining backing strip into a convenient size. Remove the remaining backing strip and tightly wrap the SRM around the connector and exposed conductor. Be sure to fill the gaps and low spots around the connector.

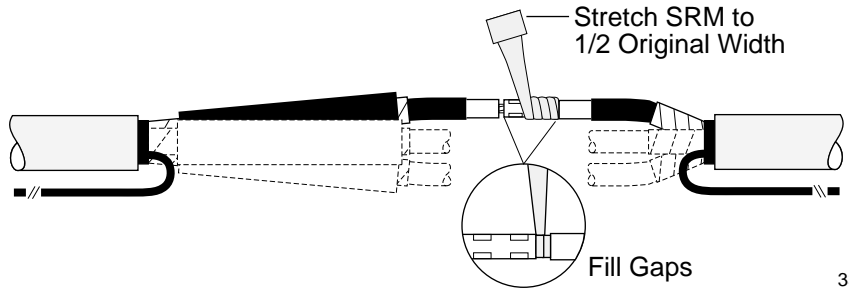

331

Continue to wrap SRM onto the solvent cleaned insulation as shown.

**Note:** If connector diameter is larger than insulation diameter, apply two half-lapped layers of SRM over the entire connector. Discard any excess SRM (long strips).

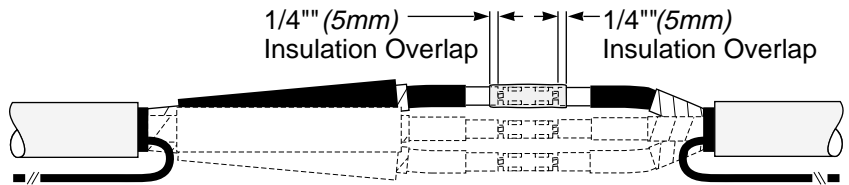

332

## 9. Apply SRM at semi-con cutback.

Remove backings from the *short angle-cut piece* of SRM. Place tip of SRM at semi-con cutback and tightly wrap to fill semi-con step. Overlap semi-con and insulation as shown. Taper SRM down to meet insulation.

**Note:** If using UniShield cable, apply SRM as shown to fill conductive jacket step.

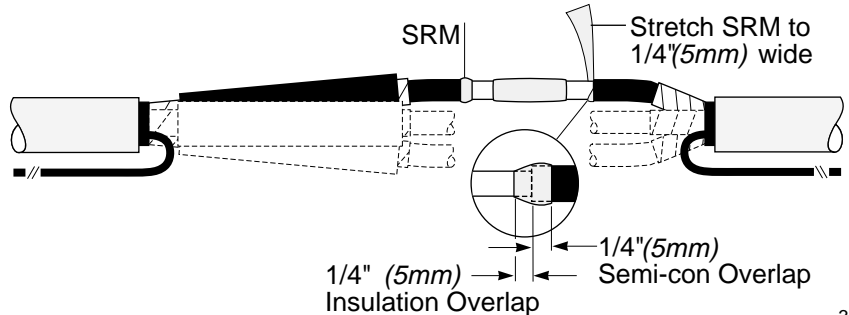

333

## 10. Apply red sealant.

Remove the backing from the red sealant and place one complete wrap onto the cable semi-con butted against the SRM as shown.

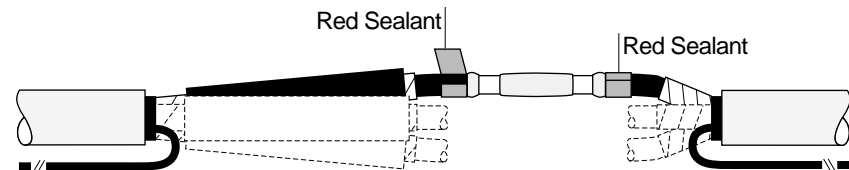

334

## 11. Position tube over connection.

Center black/red dual layer tube over completed connector area.

**Repeat Steps 8-11 on the remaining phases.**

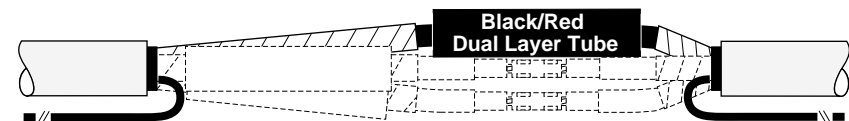

335

**12. Check position of tubes; shrink in place.**

Make sure each tube is centered over the connection area. Shrink all three tubes in place at the same time.

Begin shrinking at center of tube (1), working torch with a smooth, brushing motion around the tube. After center portion shrinks, work torch as before toward one end (2), then to the opposite end (3). Apply sufficient heat to ensure softening of the SRM, indicated by a smooth surface profile.

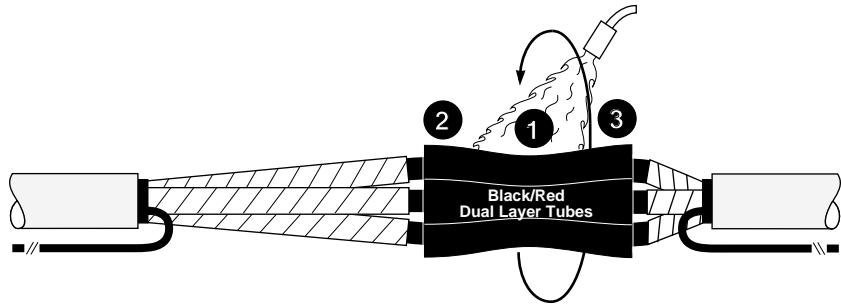

**Note:** Do not point the flame directly at the cable semi-con layer.

336

**Note: If External Grounding or Shield Interrupting**

Refer to Raychem HVS-EG, "Guide for External Grounding and Shield Interrupting of Power Cable Splices" for modifications to these instructions.

**13. Install ground.**

Choose the appropriate cable type (Choice 1-2) and follow the directions given.

**CHOICE 1**

**If Metallic Tape Shield Cable**

(1) Flare one end of the ground braid and place it onto the metallic tape butted up to the installed splice tube.  
 (2) Attach the braid to the shield by placing two wraps of the spring clamp over the braid.  
 (3) Fold the braid back over the spring clamp wraps. Continue to wrap the remaining clamp over the braid. Tighten clamp by twisting it in the direction it is wrapped and secure with copper foil tape provided.

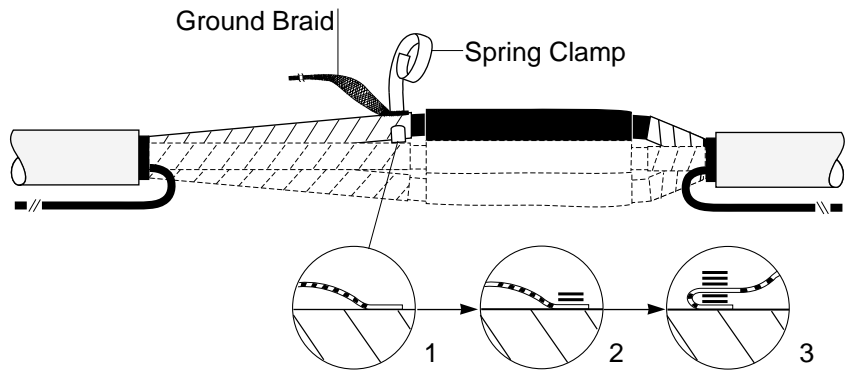

337

(4) Lay the braid across the splice tube and onto the exposed tape shield on the other side.  
 (5) Make two wraps of the clamp over the braid.  
 (6) Fold the braid back toward the splice and finish wrapping the clamp. Tighten and secure. Cut off excess braid. Repeat Choice 1 for remaining phases.

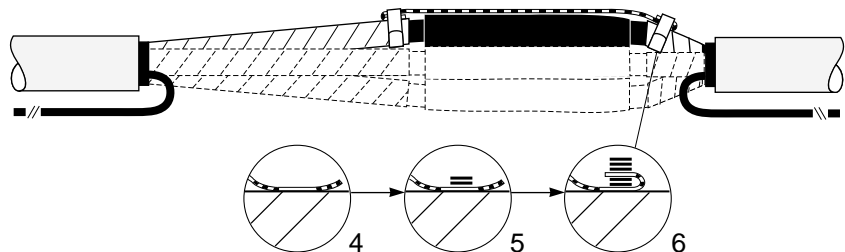

Discard connectors.

**Go to Step 14, page 7.**

338

**CHOICE 2**

**If Drain Wire or UniShield Cable**

Pigtail the wires on each side.  
Crimp the ground braid onto one pigtail with the connector provided.

Lay braids across splice tubes and attach to pigtail on the other side.  
Cut off excess braid and trim pigtailed wires. Repeat Choice 2 for remaining phases.

Discard spring clamps and foil tape.

**Go to Step 14.**

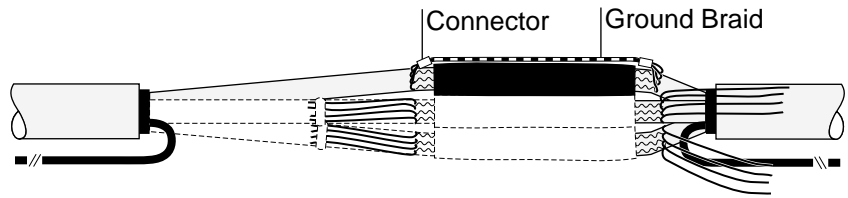

339

**14. Connect grounding conductor(s).**

Bend the grounding conductor(s) back over the tubes and splice with a suitable connector.

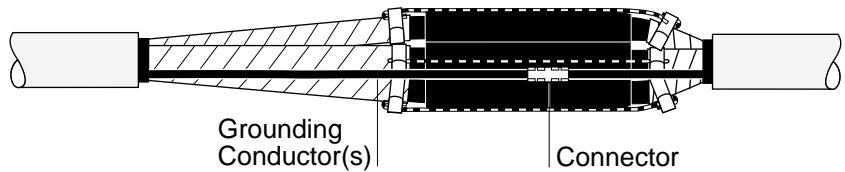

340

**15. Install the shielding mesh.**

Starting on the cable shields, wrap a half-lapped layer of the mesh around all three phases across the length of the tubes and tie off on the shields at the other side of the splice.

Abrade and solvent clean cable jackets as shown to provide an oil-free surface.

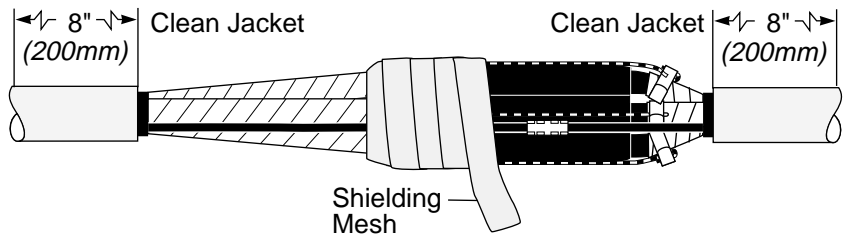

341

**16. Position wraparound sleeve.**

Remove or tape over all sharp points to prevent puncture of wraparound sleeve.

Remove backing from the wraparound sealing sleeve and center sleeve over aplice. Slide metal channel(s) onto the butted rails.

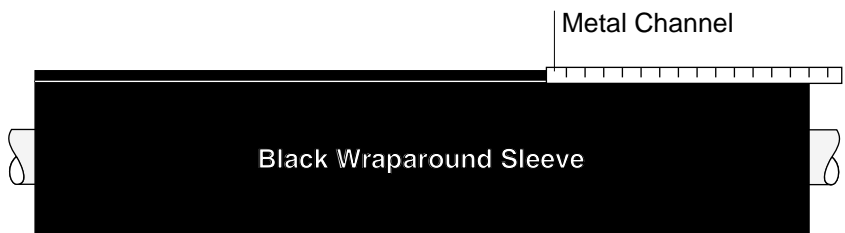

342

## Installation Instructions

### 17. Install channel clip.

If two channels are used, connect the channels with the short channel retention clip. Use pliers to install clip.

**Note:** Channel(s) must overlap sleeve edge by 1/4" (5mm) minimum.

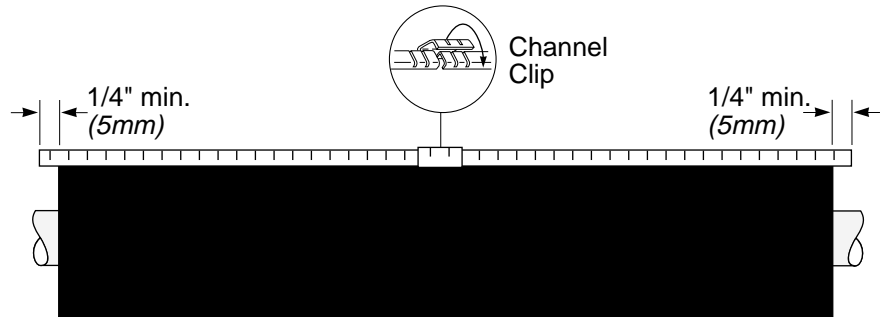

343

### 18. Shrink the wraparound sleeve.

Begin shrinking at the center and work toward each end. Post heat the entire sleeve (concentrating on metal channel area) for 30 seconds after completely shrunk.

**This completes the splice.**

**Note:** Allow to cool before moving or placing in service.

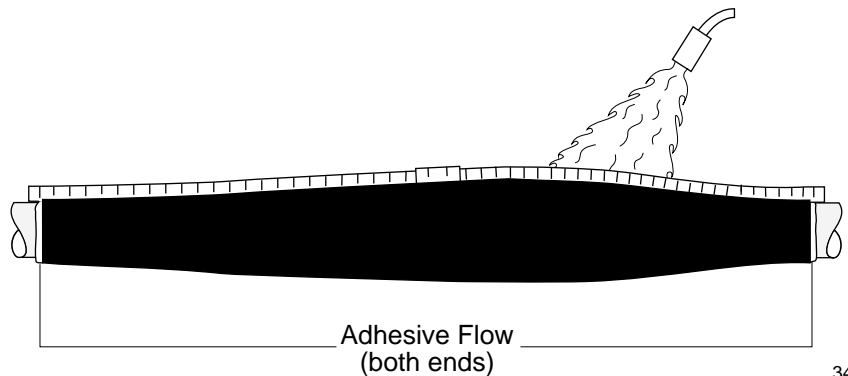

344