

HVS-T-1580S 15kV Class

Trifurcating Transition Splice for 3/C PILC or 3 1/C Extruded Dielectric (Poly/EPR) Power Cables

ENERGY DIVISION

Suggested Installation Equipment (not supplied with kit)

- Cable preparation tools
- Tyco Electronics P63 cable preparation kit or cable manufacturer approved solvent
- Clean, lint-free cloths
- Non-conducting abrasive cloth, 120 grit or finer
- Electrician's tape
- Connector(s) and installation tools
- Tyco Electronics recommended torch

Safety Instructions

DANGER: When installing electrical power system accessories, failure to follow applicable personal safety requirements and written installation instructions could result in fire or explosion and serious or fatal injuries.

To avoid risk of accidental fire or explosion when using gas torches, always check all connections for leaks before igniting the torch and follow the torch manufacturer's safety instructions.

To minimize any effect of fumes produced during installation, always provide good ventilation of confined work spaces.

As Tyco Electronics has no control over field conditions which influence product installation, it is understood that the user must take this into account and apply his own experience and expertise when installing product.

Note: The braids supplied in this kit are sized for shield continuity purposes only. Check sizing of braid to insure they meet the needs of your circuit.

HVS-T-1581S	# 8 AWG
HVS-T-1582S	# 6 AWG
HVS-T-1583S & 1584S	# 4 AWG

Recommended Tyco Electronics Torches

Install heat-shrinkable cable accessories with a "clean burning" torch, i.e., a propane torch that does not deposit conductive contaminants on the product.

Clean burning torches include the Tyco Electronics FH-2629, FH-2649 (uses refillable propane cylinders) and FH-2618A (uses disposable cylinder).

Adjusting the Torch

Adjust regulator and torch as required to provide an overall 12- inch bushy flame. The FH-2629 will be all blue, the other torches will have a 3- to 4-inch yellow tip. Use the yellow tip for shrinking.

Regulator Pressure

FH-2618A	Full pressure
FH-2649	25 psig
FH-2629	15 psig

General Shrinking Instructions

- Apply outer 3- to 4-inch tip of the flame to heat-shrinkable material with a rapid brushing motion.
- Keep flame moving to avoid scorching.
- Unless otherwise instructed, start shrinking tube at center, working flame around all sides of the tube to apply uniform heat.

To determine if a tube has completely recovered, look for the following, especially on the back and underside of the tube:

1. Uniform wall thickness.
2. Conformance to substrate.
3. No flat spots or chill marks.
4. Visible sealant flow if the tube is coated.

Note: When installing multiple tubes, make sure that the surface of the last tube is still warm before positioning and shrinking the next tube. If installed tube has cooled, re-heat the entire surface.

Table 1

Kit	PILC/Poly Nominal Cable Range	PILC Insulation Diameter Range	Poly Insulation Diameter Range	Poly Maximum Jacket Diameter	Maximum Connector Dimensions	
					Length	Diameter
HVS-T-1581S	#4-4/0	0.60-1.00 (15-25mm)	0.65-1.05 (17-27mm)	1.35 (34mm)	4.5 (115mm)	0.90 (23mm)
HVS-T-1582S	4/0-350	0.85-1.10 (22-28mm)	0.90-1.30 (23-33mm)	1.50 (38mm)	5.5 (140mm)	1.15 (29mm)
HVS-T-1583S	500-750	1.05-1.50 (27-38mm)	1.10-1.60 (28-41mm)	1.90 (48mm)	7.0 (178mm)	1.60 (41mm)
HVS-T-1584S	750-1000	1.25-1.75 (32-44mm)	1.25-1.80 (32-46mm)	2.15 (55mm)	8.0 (203mm)	1.85 (47mm)

1. Prepare cables

Choose the splice type (Choice 1-5) and follow the directions given.

Table 2

Kit	Poly Jacket Cutback A	Poly Semi-con Cutback B	PILC Jacket Cutback C*
HVS-T-1581S	10" (254mm)	5-1/2" (140mm)	19" (483mm)
HVS-T-1582S	11" (279mm)	6" (152mm)	20" (508mm)
HVS-T-1583S	12" (305mm)	7" (178mm)	22" (559mm)
HVS-T-1584S	13" (330mm)	7-1/2" (190mm)	23" (584mm)

*Mark PILC cable, if unjacketed.

CHOICE 1

If PILC to Metallic Tape Shield, Lead Sheath or LC Shield Cable

Refer to Table 2 and prepare the cables as shown.

Go to Step 2.

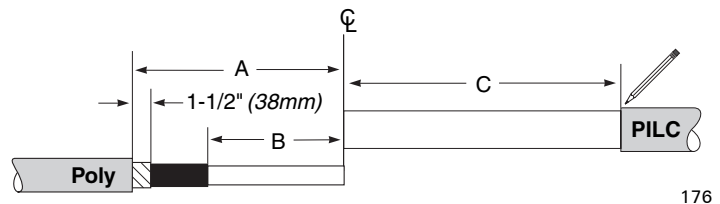

176

CHOICE 2

If PILC to Drain Wire Shield Cable

Refer to Table 2 and prepare the cables as shown.

Go to Step 2.

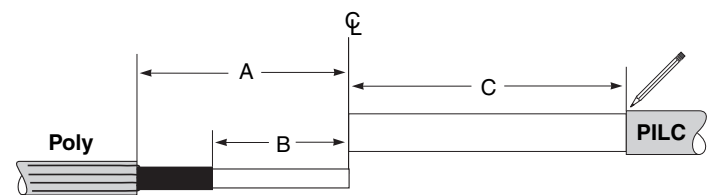

177

CHOICE 3

If PILC to UniShield Cable

Refer to Table 2 and prepare the cables as shown. Pull back the drain wires to Dimension A.

Go to Step 2.

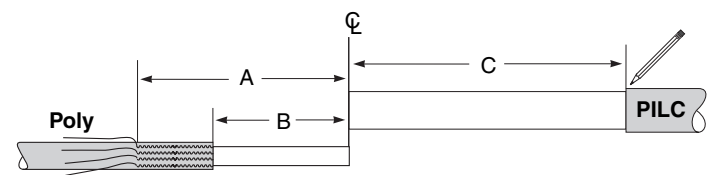

UniShield is a registered trademark of Cablec Corporation.

178

CHOICE 4

If PILC to Jacketed Concentric Neutral Cable

Refer to Table 3 and prepare the cables as shown. Cut neutral wires to dimension E and temporarily tape over ends.

Go to Step 2.

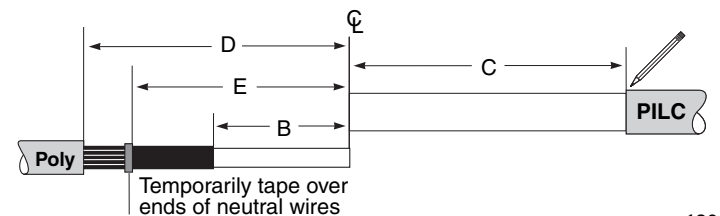

180

Table 3

Kit	Poly Poly Jacket Cutback D	Poly Wire Cutback E	PILC Semi-con Cutback B	Jacket Cutback C*
HVS-T-1581S	13" (330mm)	9" (229mm)	5-1/2" (140mm)	19" (483mm)
HVS-T-1582S	13" (330mm)	9" (229mm)	6" (152mm)	20" (508mm)
HVS-T-1583S	15" (381mm)	10" (254mm)	7" (178mm)	22" (559mm)
HVS-T-1584S	17" (432mm)	11" (279mm)	7-1/2" (190mm)	23" (584mm)

*Mark PILC cable, if unjacketed.

CHOICE 5

If PILC to Concentric Neutral Cable

Refer to Table 4 and prepare the cables as shown. Cut neutral wires to Dimension F and temporarily tape over ends.

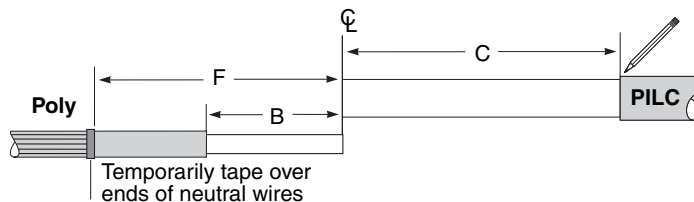

Go to Step 2.

179

Table 4

Kit	Poly Wire Cutback F	Poly Semi-con Cutback B	PILC Jacket Cutback C*
HVS-T-1581S	12" (305mm)	5-1/2" (140mm)	19" (483mm)
HVS-T-1582S	13" (330mm)	6" (152mm)	20" (508mm)
HVS-T-1583S	14" (355mm)	7" (178mm)	22" (559mm)
HVS-T-1584S	15" (381mm)	7-1/2" (190mm)	23" (584mm)

*Mark PILC cable, if unjacketed.

2. Prepare lead sheath.

Abrade the lead sheath and clean with oil-free solvent as shown.

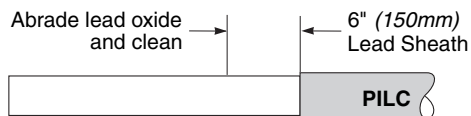

653

3. Remove lead sheath as shown.

Kit	Lead Sheath Cutback G
HVS-T-1581S	14" (355mm)
HVS-T-1582S	15" (380mm)
HVS-T-1583S	16" (405mm)
HVS-T-1584S	17" (430mm)

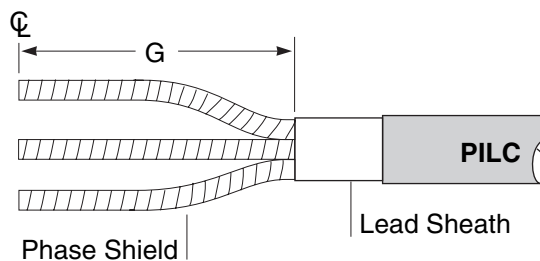

101

4. Cut back shield or belt papers.

Choose the cable type and follow the directions given.

CHOICE 1

If Shielded PILC Cable

Cut back any bedding and/or shielding tapes over all three phases to lead sheath cutback. Cut back phase shields and remove any conductive material from paper insulation as shown.

Tack solder metal tape shields to prevent unwrapping and tape over sharp edges with one wrap of electrician's tape.

Go to Step 5.

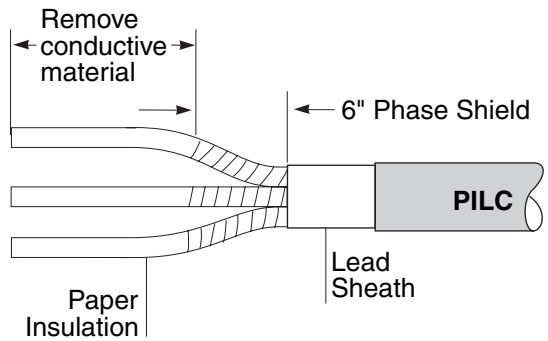

102

CHOICE 2

If Belted PILC Cable

Remove belt papers as shown.

Go to Step 5.

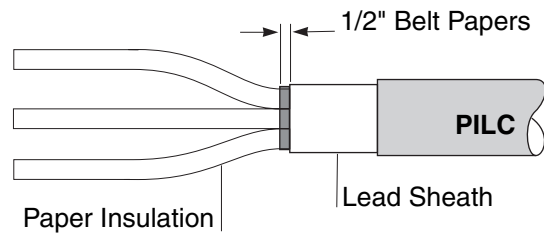

103

5. Mark insulation as shown.

Kit	H	
HVS-T-1581S	3-1/2"	(89mm)
HVS-T-1582S	4"	(102mm)
HVS-T-1583S	5"	(127mm)
HVS-T-1584S	5-1/2"	(140mm)

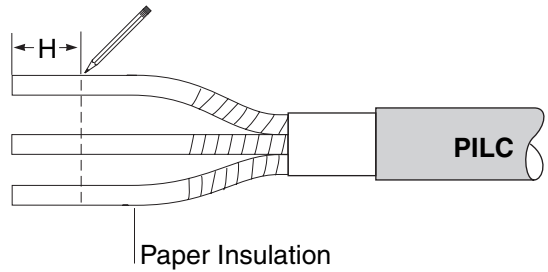

104

6. Apply Stress Relief Material (SRM).

Remove backing strip from one side of a *long strip* of SRM. Roll up the SRM and remaining backing strip into a convenient size.

Removing the remaining backing strip, tightly wrap one, half-lapped layer of SRM around each phase as shown. Wrap SRM in same direction as insulating papers on cable.

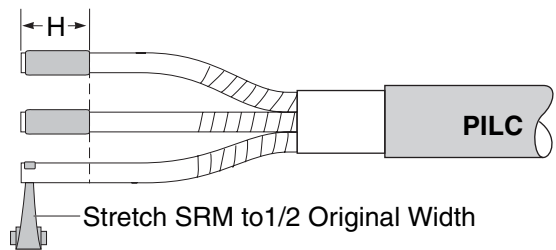

105

7. Position OBT; shrink in place.

Place an Oil Barrier Tube (OBT) over each phase, butted to the lead sheath (or belt paper) cutback. Shrink the three OBTs in place starting at the lead sheath cutback.

Note: To achieve a smooth, wrinkle-free installation, use a reduced flame to install the thin-walled OBT.

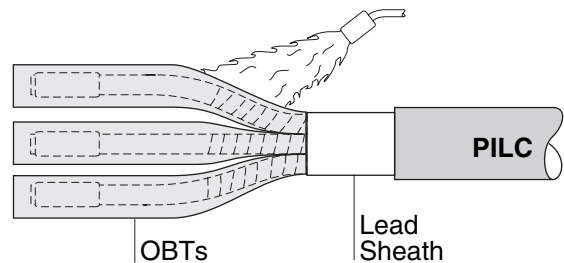

394

8. Inspect OBTs.

The installed OBTs should have a smooth, wrinkle-free surface after shrinking. Reheat to smooth any wrinkled areas.

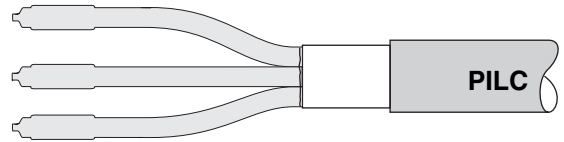

395

9. Mark OBT/ Insulation at l.

Kit	l	
HVS-T-1581S	6-1/2"	(165mm)
HVS-T-1582S	7"	(178mm)
HVS-T-1583S	8"	(203mm)
HVS-T-1584S	8-1/2"	(216mm)

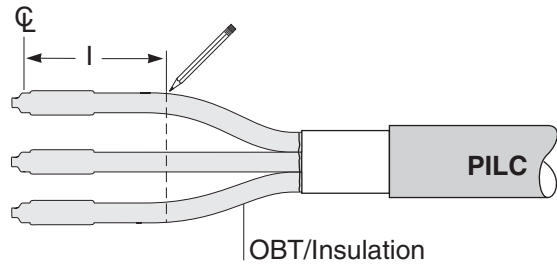

220

10. Position black conductive tubes; shrink in place.

Place black conductive tube over each phase and position at dimension l.

Shrink in place starting at the end nearest to the center of the splice.

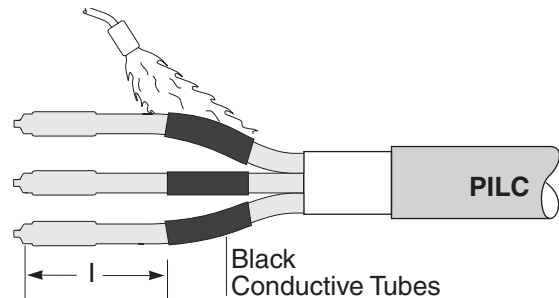

221

11. Clean OBTs.

Using the solvent wipes provided, clean the OBT/Insulation, as shown.

Note: Clean the entire surface of the OBT, not just the outer surface.

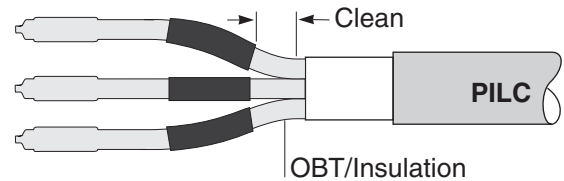

222

12. Install SRM insert.

Assemble SRM insert per box instructions. Using a solvent wipe, wipe the surface of the insert to provide lubrication for easier positioning. Spread the phases and position the insert as shown.

Caution: To prevent insulation damage, do not overbend the phases!

Note: The SRM insert is packaged inside the conductive breakout.

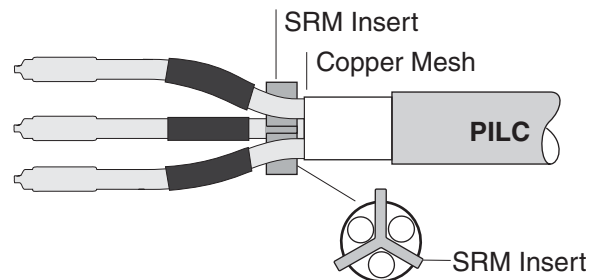

223

13. Trim excess SRM insert.

Trim SRM insert to extend 1/8" (3mm) beyond each phase.

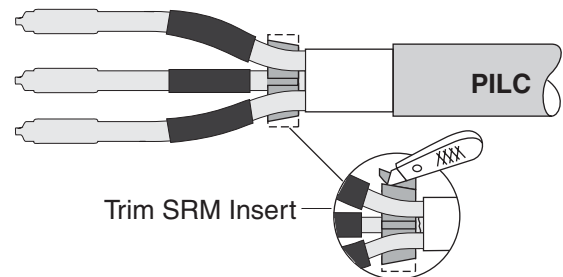

224

14. Clean lead sheath.

Reclean lead sheath as shown using an oil-free solvent.

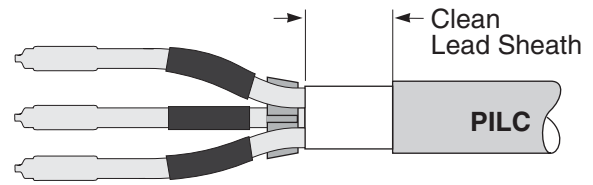

15. Mark lead sheath as shown.

Note: To ensure SRM to OBT adhesion, gently heat the SRM insert and adjacent OBT before moving on to the next step.

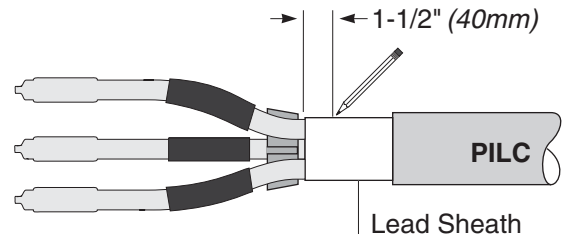

16. Install oil seal.

Remove backing from one side of a *long strip* of SRM. Roll the SRM and remaining backing strip into a convenient size. Removing the remaining backing strip, tightly wrap the SRM from the mark on the lead sheath to the outer edge of the SRM insert. Four to six strips of SRM should be used to build the SRM to the shape shown.

Note: Do not over apply. The finished SRM diameter should not exceed that of the breakout installed in the next step.

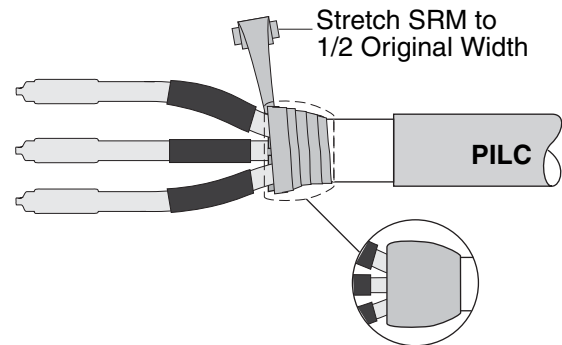

17. Position conductive breakout; shrink in place.

Position the conductive breakout over the SRM so that the inside butts up hard against the SRM.

Shrink in place starting at the fingers and working toward the other end.

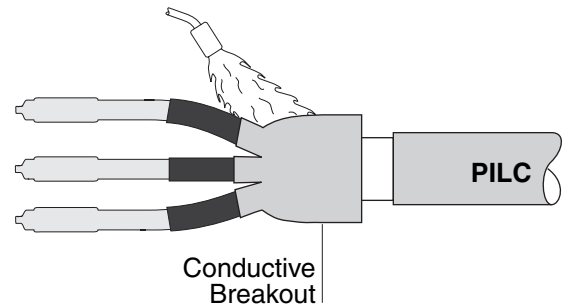

18. Inspect breakout.

After the breakout has shrunk, continue to apply heat until the breakout has a smooth, uniform surface.

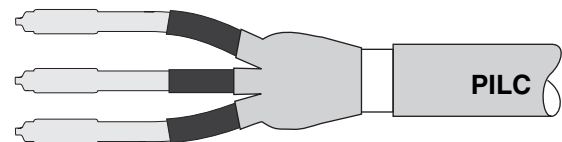

19. Clean cables; position splice components.

Abrade insulation, if necessary, to remove imbedded semi-con. Clean Poly cable jackets for 30" (760mm).

Place sealing breakout over the Poly cables with the fingers pointing away from the splice center.

Place one set of nested tubes over each clean Poly cable.

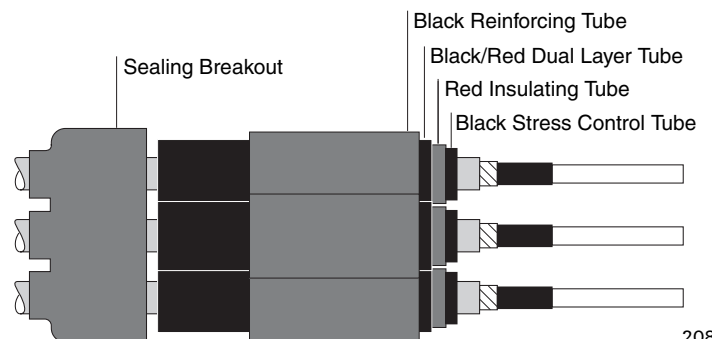

20. Remove insulation.

Refer to Table 5 and cutback the insulation as shown.

Note: If using Tyco Electronics CSBS ShearBolt connectors, refer to the installation instruction packaged with the connector for insulation cutback dimensions.

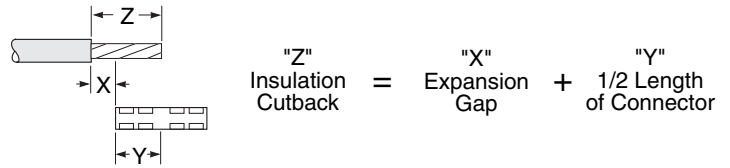

400

Table 5: Connector Dimensions

Kit	Max Length		Max O.D.		Expansion Gap "X"	
		(mm)		(mm)		(mm)
HVS-T-1581S	4-1/2"	(114mm)	0.90"	(23mm)	1/4"	(5mm)
HVS-T-1582S	5-1/2"	(140mm)	1.15"	(29mm)	1/4"	(5mm)
HVS-T-1583S	7"	(178mm)	1.60"	(41mm)	1/2"	(10mm)
HVS-T-1584S	8"	(203mm)	1.85"	(47mm)	1/2"	(10mm)

21. Install connectors.

Make sure connector has center oil stop.

After installation, deburr connections.

Note: A Poly tape shield to PILC splice is shown in this instruction as an example. Any cable combination discussed earlier can be used.

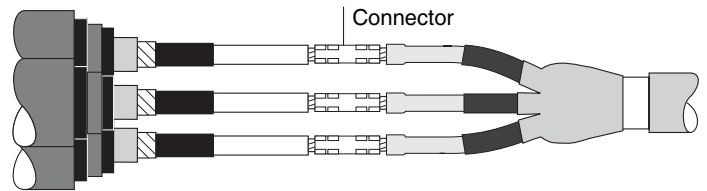

303

22. Clean connector area.

Complete Steps 22-26 working on one phase at a time.

Using an oil-free solvent, clean the insulation as shown, paying particular attention to the OBT/insulation surface.

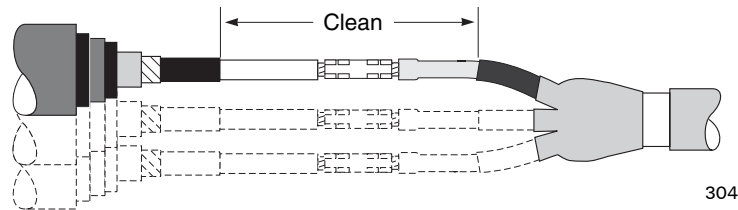

304

23. Apply SRM over connector.

Remove backing from one side of a *long strip* of SRM. Roll the SRM and remaining backing strip into a convenient size. Removing the remaining backing strip, tightly wrap the SRM around the connector and exposed conductor. Be sure to fill the gaps and low spots around the connector.

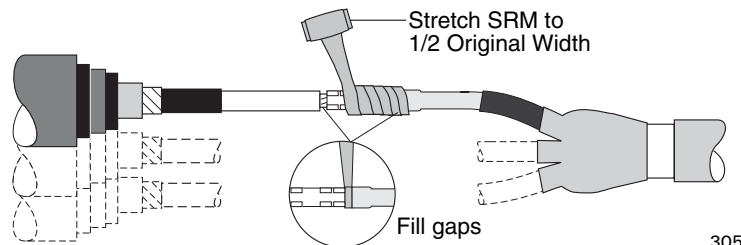

305

Continue to wrap the SRM onto the insulation as shown.

Note: If the connector diameter is larger than the insulation diameter, apply two half-lapped layers of SRM over the entire connector. Discard any excess SRM (long strips).

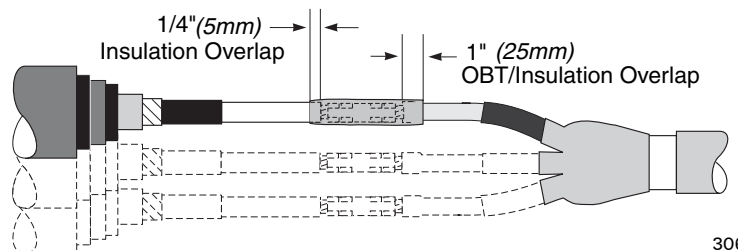

306

24. Apply SRM at black conductive tube step.

Remove backings from the *short angle-cut piece* of SRM. Place tip of SRM at black conductive tube step and tightly wrap to fill the step. Overlap black conductive tube and OBT/Insulation and taper down to meet OBT insulation as shown.

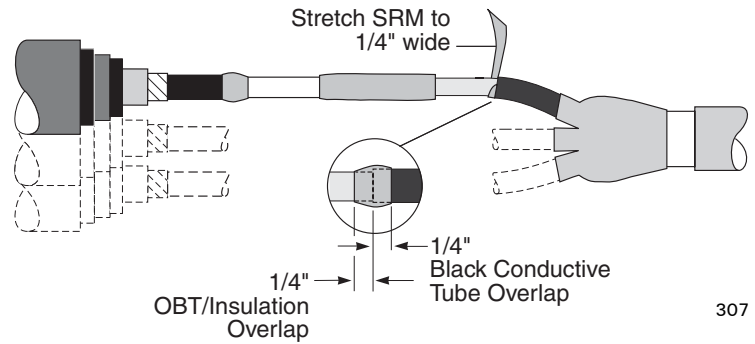

307

25. Apply Silicon Grease (SG).

Apply a thin film of silicone grease over the applied SRM.

Note: If using UniShield cable, apply SRM as shown to fill conductive jacket step.

Snip open the end of the silicone grease tube and apply a thin film of grease on the SRM over the connector and semi-con steps.

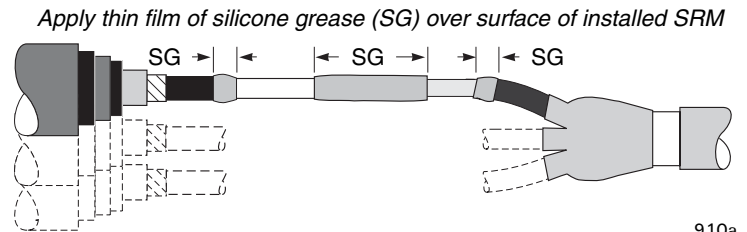

910a

26. Position black stress control tube.

Center black stress control tube over the completed connector area. Be sure to equally overlap the Poly cable semi-con and the PILC cable black conductive tube.

Repeat Steps 23-27 for the remaining two phases.

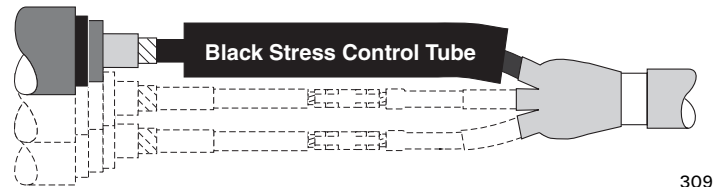

309

27. Check position of black stress control tubes; shrink in place.

Center the tubes over the splice. Begin shrinking at the center (1) of the tubes, working the torch around all sides of the tubes. After the center portion shrinks, work towards one end (2), then to the opposite end (3).

Note: Do not point the flame at the cable semi-con.

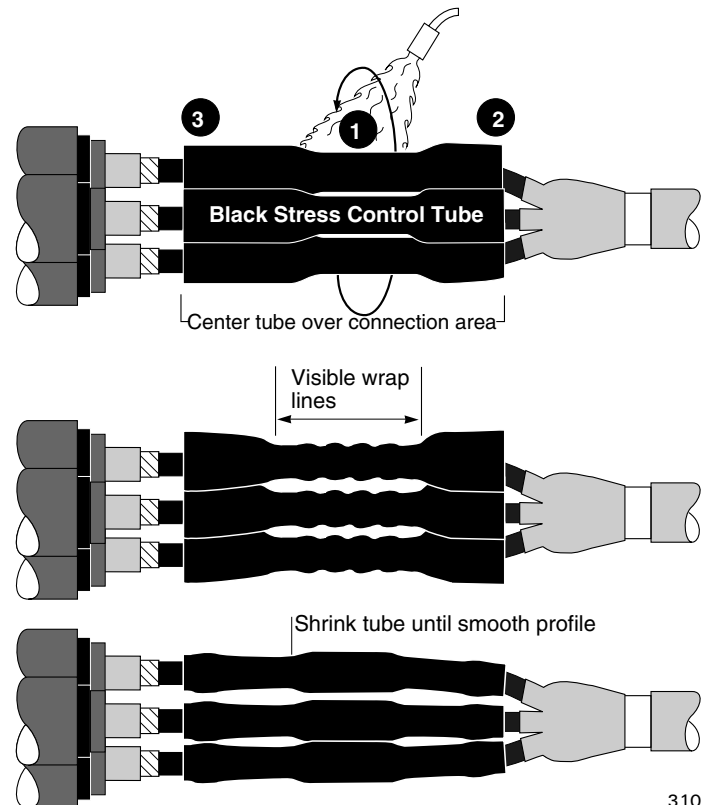

310

28. Position red insulating tubes; shrink in place.

Center tubes over the black stress control tubes. Shrink in place using the same method as in Step 28.

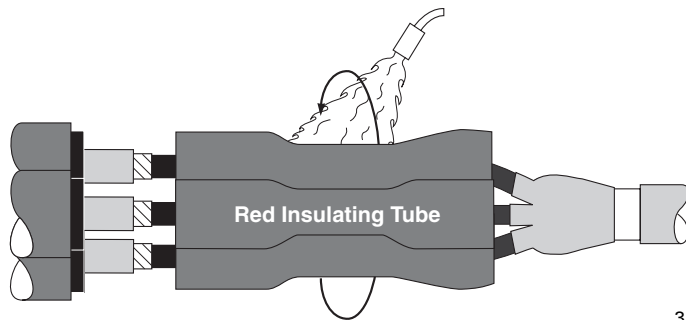

311

29. Apply red sealant.

Remove backing from red sealant. Using light tension, wrap sealant over the cable, butted against the red insulating tube as shown. Build the sealant to the level of the red insulating tube.

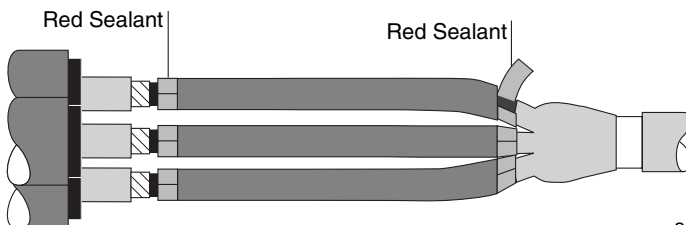

312

30. Position black/red dual layer tubes; shrink in place.

Center tubes over the red insulating tubes. Shrink in place using the same method as in Step 28.

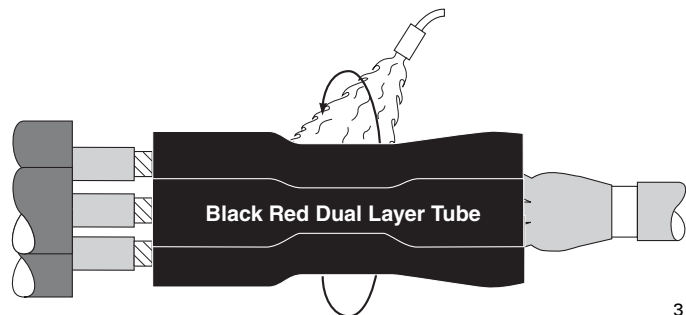

313

31. Position black reinforcing tubes; shrink in place.

Center tubes over the black/red dual layer tubes. Shrink in place using the same method as in Step 28.

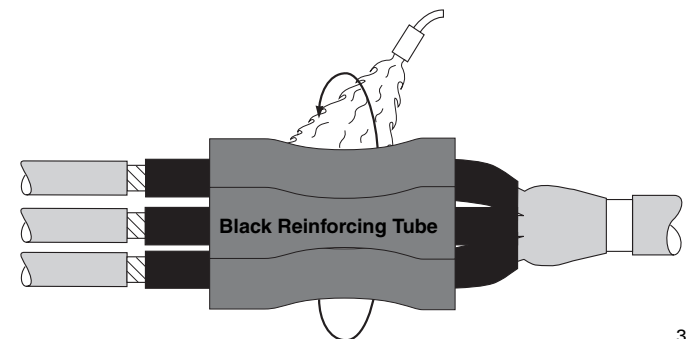

314

Note: If External Grounding or Shield Interrupting

Refer to the Raychem HVS-EG, "Guide for External Grounding and Shield Interrupting of Power Cable Splices" for modifications to these instructions.

32. Install ground.

Choose the appropriate cable type (Choice 1-5) and follow the directions given to ground each phase.

CHOICE 1

If Unjacketed Concentric Neutral Cable

Go to Step 1, page 13.

CHOICE 2

If Drain Wire or UniShield Cable

Pigtail the shield wires and crimp on to the ground braid using the connectors provided.

Lay the braids across the splice tubes and solder ground braids to the lead sheath of the PILC cable. Deburr the connection, cut off excess braid and trim pigtailed wires.

Discard spring clamp and foil tapes.

Go to Step 34.

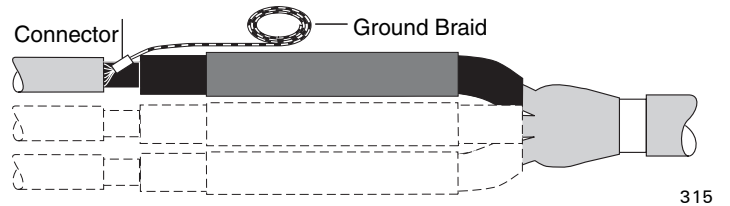

315

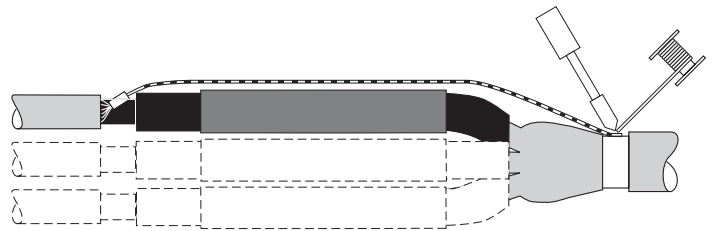

316

CHOICE 3

If Metallic Tape or LC Shield Cable

- (1) Flare one end of the ground braid and place it onto the metallic tape, butted up to the red sealant.
- (2) Attach the braid to the shield by placing two wraps of the spring clamp over the braid.
- (3) Fold the braid back over the spring clamp wraps. Continue to wrap the remaining clamp over the braid. Tighten clamp by twisting it in the direction it is wrapped and secure with copper foil tape provided.

Lay the braids across the splice tubes and solder ground braids to the lead sheath of the PILC cable. Deburr the connection, cut off excess braid and trim pigtailed wires.

Discard drain wire connectors.

Go to Step 34.

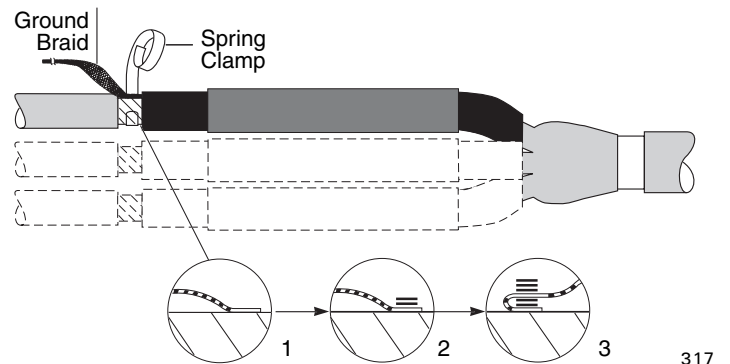

317

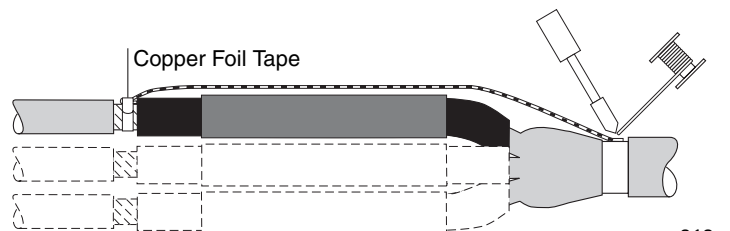

318

CHOICE 4

If Lead Sheath Cable

Solder ground braids onto lead sheath. Lay the braids across the splice tubes and solder to the lead sheath of the other side. Deburr the connection and cut off excess braid.

Discard spring clamps, drain wire connectors, and foil tapes.

Go to Step 34.

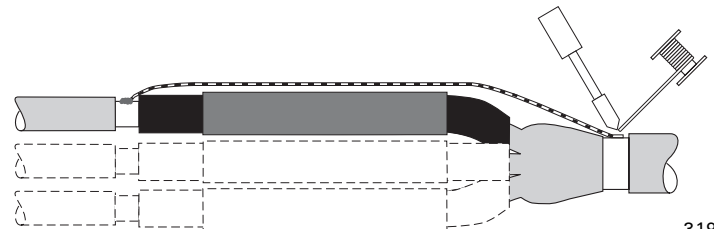

319

CHOICE 5

If Jacketed Concentric Neutral Cable

Pigtail the neutral wires and crimp or solder to the ground braid.

Lay the braids across the splice tubes and solder ground braids to the lead sheath of the PILC cable. Deburr the connection, cut off excess braid and trim pigtailed wires.

Discard spring clamps, drain wire connectors, and foil tapes.

Go to Step 34.

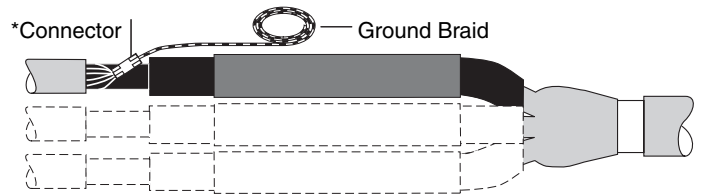

*Not supplied in kit.

361

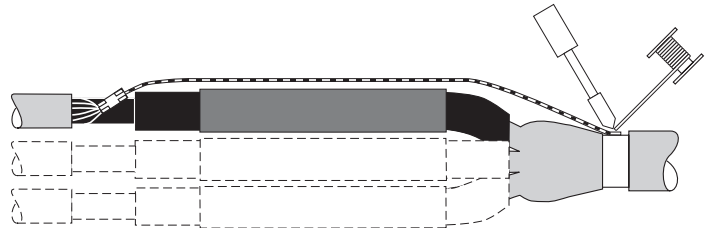

362

34. Apply shielding mesh.

Starting over the ground connections on the extruded dielectric side of the splice, wrap one half-lapped layer of 2-inch (50mm) wide shielding mesh across the splice and solder to the PILC cable lead sheath.

Abrade and solvent clean cable jackets (or lead sheath) as shown using an oil-free solvent.

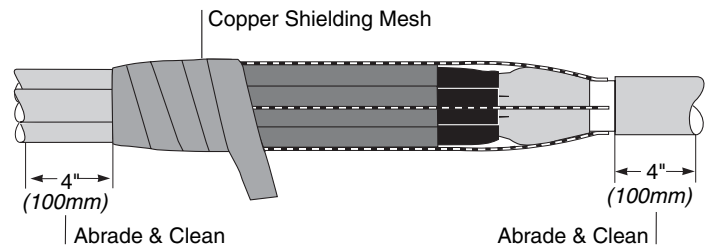

363

35. Position non-conductive sealing breakout; shrink in place.

Make sure that the full length of the fingers of the breakout are over the extruded dielectric cable jackets with the body extending over the splices.

Shrink in place starting at the fingers and working toward the splice center.

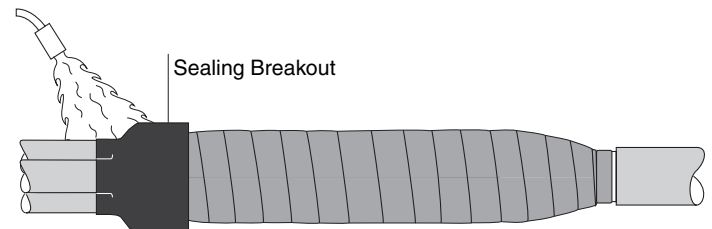

364

36. Apply red sealant.

Allow breakout to cool sufficiently to touch before proceeding.

Apply one wrap of red sealant over the body of the breakout as shown.

Apply one wrap of red sealant over the PILC outer sheath as shown.

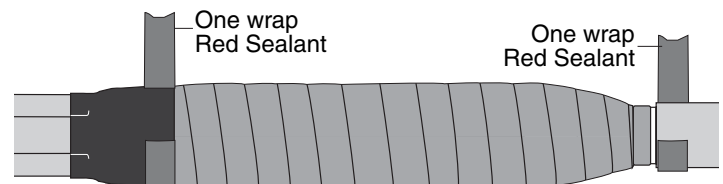

365

37. Position wraparound sleeve.

Remove or tape over all sharp points to prevent puncture of wraparound sleeve.

Remove backing from the wrap-around sealing sleeve and center sleeve over splice. Slide metal retention clip onto butted rails.

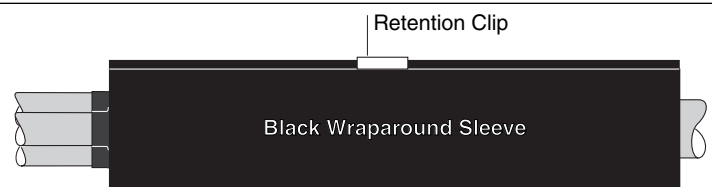

366

38. Install channels.

Slide the channels toward the center from each end of the sleeve and over the retention clip. A minimum of 1/4 inch of channel should be extended beyond the edges of the sleeve.

If channels slide on easily go to step 39. If channel fit seems tight, continue with next paragraph.

As shown in illustration A, make sure flap is not pinched between the rails. Push the sleeve up from the bottom and down from the top while sliding on channel as shown in illustration B. The idea is to flatten the rails together to prevent the channels from binding.

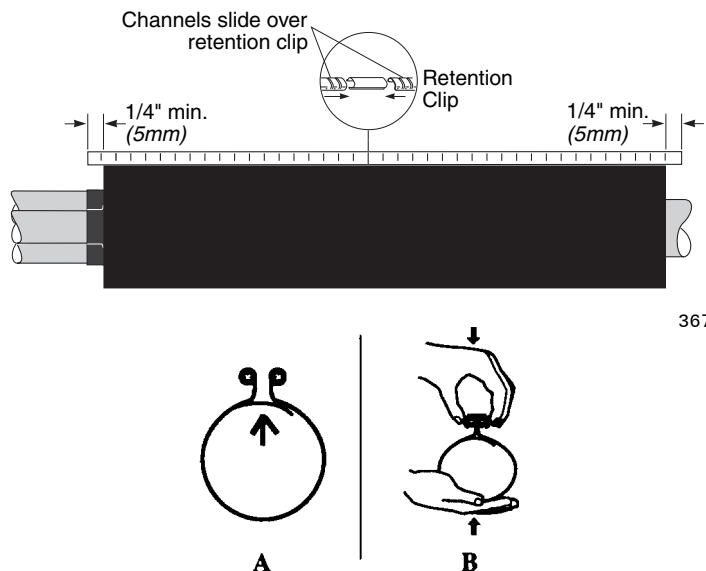

367

39. Shrink wraparound sleeve.

Preheat evenly along both sides of the rail/channel area until this area begins to shrink. To achieve uniform heating, move the flame back and forth from one side of the channel to the other as shown in illustration "A" while moving flame along the entire length of the channel as shown in illustration "B" until the sleeve starts to shrink. This technique will assure a properly preheated rail and channel area.

Begin shrinking at the center of the sleeve and work toward each end. Apply heat until the sleeve is fully shrunk and the heat-sensitive green paint is completely converted to black. Continue heating the rail/channel area for another 5 seconds per foot. A white line should be visible in the channel gaps indicating sufficient heating.

Note: Green heat-sensitive paint will turn black as sleeve shrinks in place.

This completes the splice.

Note: Allow to cool before moving or placing in service.

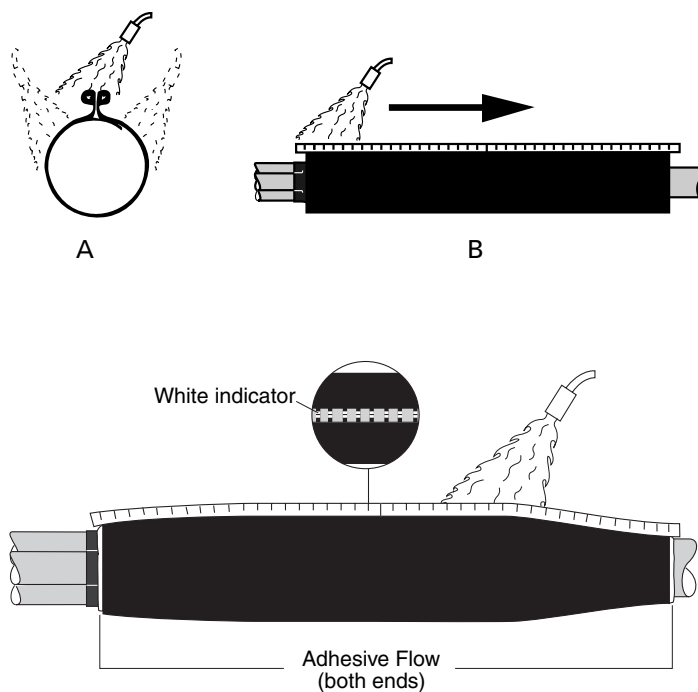

368

Unjacketed Concentric Neutral Cable Only

1. Install ground braids.

Space the braids evenly around the PILC cable and solder to the lead sheath.

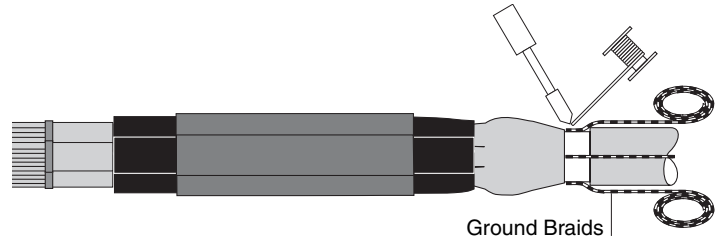

436

2. Solder block ground braids.

To prevent the ingress of moisture, solder-block the ground braids for 2 inches (50mm) from the PILC jacket cut measurement (or equivalent measurement if unjacketed).



437

3. Clean PILC cable jacket.

Solvent clean and abrade the cable jacket as shown.

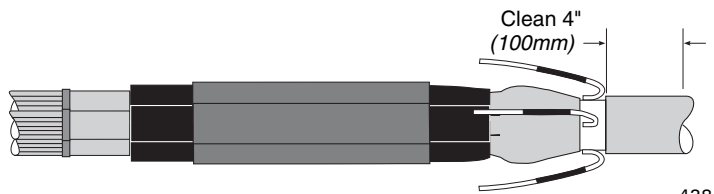

438

4. Apply red sealant.

Apply one layer of red sealant onto the cable jacket as shown.

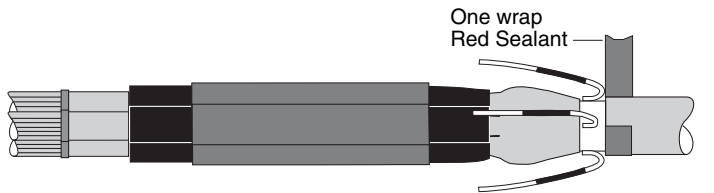

439

5. Apply red sealant.

Bring the braids forward and temporarily tape them to the PILC cable to hold them in position.



440

Press the braids onto the sealant. Apply one layer of sealant directly over the braids and the first layer of sealant.

6. Apply shield mesh.

Starting at the poly cable semi-con, wrap one half-lapped layer of 2-inch (50mm) wide shielding mesh across the splice and solder to the PILC cable lead sheath.

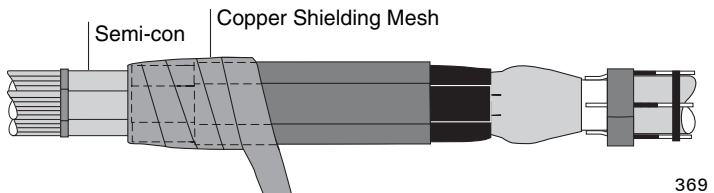

369

7. Position non-conductive sealing breakout; shrink in place.

Position the breakout on the poly cable semi-con, with the fingers clear of the neutral wires and the body over the three splices.

Shrink in place starting with the fingers and working toward the splice center.

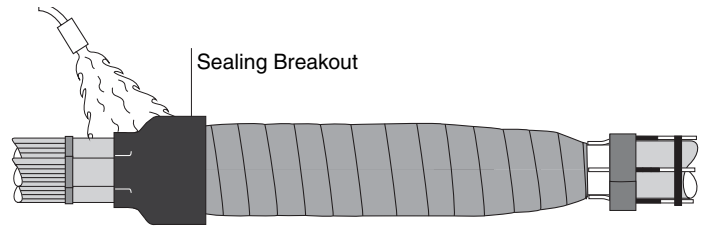

435

8. Apply red sealant.

When the breakout has cooled sufficiently to touch, apply one wrap of red sealant to the body of the breakout.

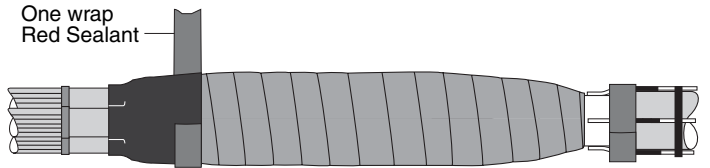

441

9. Position wraparound sleeve.

Remove or tape over all sharp points to prevent puncture of wraparound sleeve.

Remove backing from the wrap-around sealing sleeve and center sleeve over splice. Slide metal retention clip onto butted rails.

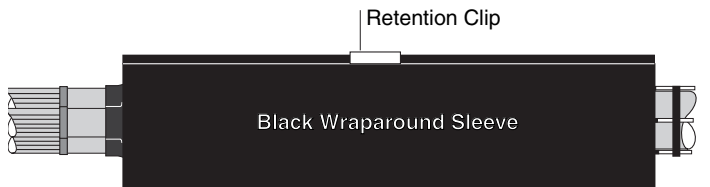

442

10. Install channels.

Slide the channels toward the center from each end of the sleeve and over the retention clip. A minimum of 1/4 inch of channel should be extended beyond the edges of the sleeve.

If channels slide on easily go to step 11. If channel fit seems tight, continue with next paragraph.

As shown in illustration A, make sure flap is not pinched between the rails. Push the sleeve up from the bottom and down from the top while sliding on channel as shown in illustration B. The idea is to flatten the rails together to prevent the channels from binding.

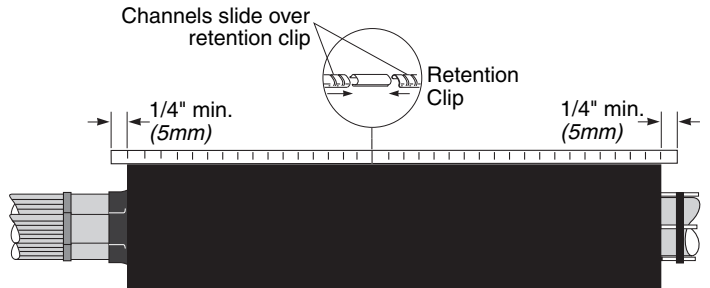

443

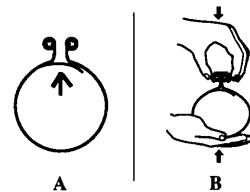

11. Shrink wraparound sleeve.

Preheat evenly along both sides of the rail/channel area until this area begins to shrink. To achieve uniform heating, move the flame back and forth from one side of the channel to the other as shown in illustration "A" while moving flame along the entire length of the channel as shown in illustration "B" until the sleeve starts to shrink. This technique will assure a properly preheated rail and channel area.

Begin shrinking at the center of the sleeve and work toward each end. Apply heat until the sleeve is fully shrunk and the heat-sensitive green paint is completely converted to black. Continue heating the rail/channel area for another 5 seconds per foot. A white line should be visible in the channel gaps indicating sufficient heating.

Note: Green heat-sensitive paint will turn black as sleeve shrinks in place.

This completes the splice.

Note: Allow to cool before moving or placing in service.

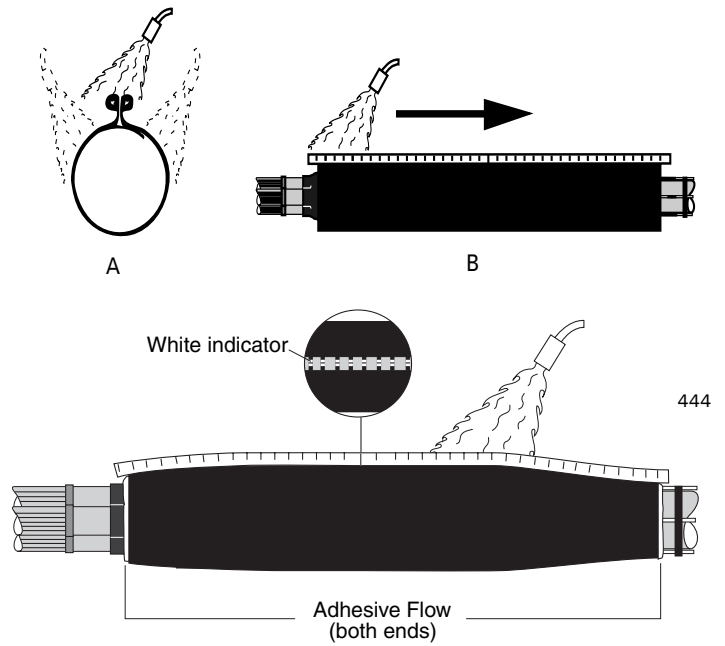

12. Connect ground braids.

Fold braids back over the splice and crimp or solder to the concentric neutral wires.

This completes the splice.

Note: Allow to cool before moving or placing in service.

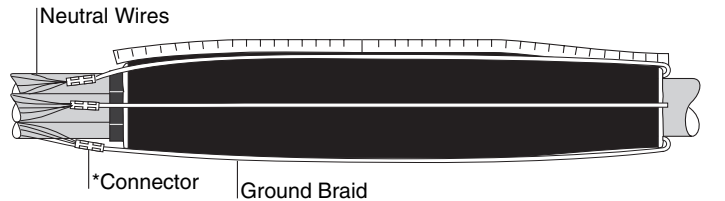

*Not supplied in kit.

The Information contained in these installation instructions is for use only by installers trained to make electrical power installations and is intended to describe the correct method of installation for this product. However, Tyco Electronics has no control over the field conditions which influence product installation. It is the user's responsibility to determine the suitability of the installation method in the user's field conditions. Tyco Electronics' only obligations are those in Tyco Electronics' standard Conditions of Sale for this product and in no case will Tyco Electronics be liable for any other incidental, indirect or consequential damages arising from the use or misuse of the products. Raychem is a trademark of Tyco Electronics Corporation. UniShield is a trademark of BICCGeneral Cable Industries, Inc. Copyright 2007 Tyco Electronics Corporation. All Rights Reserved.