

1. INTRODUCTION

This instruction sheet covers removing Fortis ZD connector modules (reference part number 2000891-1) from the pc board (daughtercard and backplane).

For application requirements of the module, refer to Application Specification 114-13267.

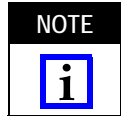

Dimensions in this instruction sheet are in millimeters. Figures are not drawn to scale.

Tools required for removal are:

- adjustable pliers
- needle-nose pliers

2. DESCRIPTION

The header (daughtercard) module consists of a shroud and chicklets that hold compliant pin contacts. The shroud is attached to the chicklets. The receptacle (backplane) module consists of a housing and compliant pin contacts. The housing and chicklets are held onto the pc board by the compliant pin contacts.

3. REMOVAL PROCEDURE

3.1. Header (Daughtercard) Module

1. Using the adjustable pliers, grasp the shroud as shown in Figure 1, Detail A.
2. Support the pc board, and gently rock the shroud back and forth while pulling the shroud away from the housing. It might be necessary to rock the

Detail A

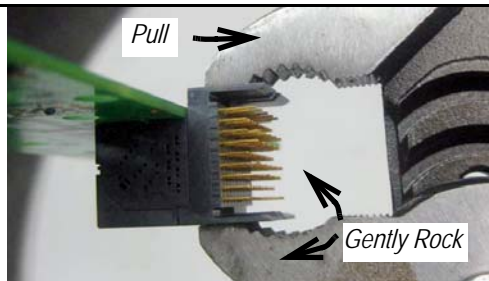

Detail B

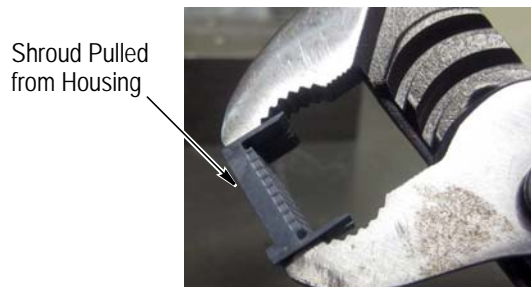
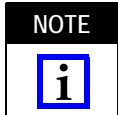

Figure 1

shroud 20 times before it is free from the housing, then slide the shroud straight away from the contact pins. See Figure 1, Detail B.



It is acceptable if the shroud breaks; however, if the contact pins bend, use the needle-nose pliers to straighten them before continuing to remove the shroud.

3. If there is access to an end chicklet, deflect the chicklet to the side, and use the needle-nose pliers to pull the chicklet up and away from the pc board. See Figure 2.

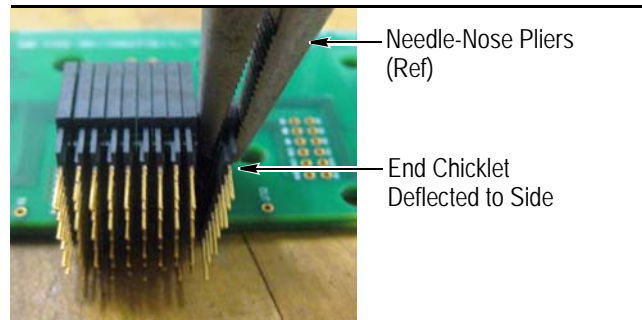
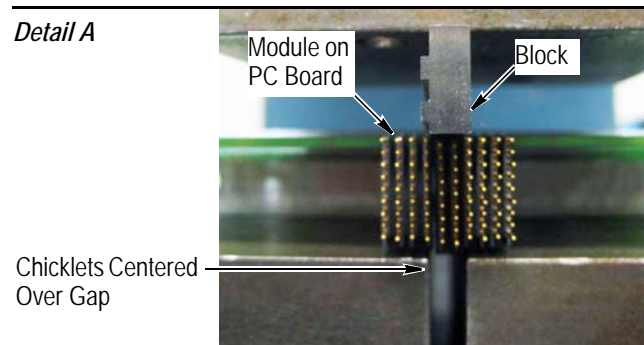

Figure 2

If there is *no* access to an end chicklet, support the module, and center two chicklets over a gap approximately 6 mm wide. Refer to Figure 3, Detail A. Using a block approximately 4-mm wide, push the centered chicklets until they are loosened from the pc board. See Figure 3, Detail B. Remove the loosened chicklets. See Figure 3, Detail C.

Detail A



Detail B

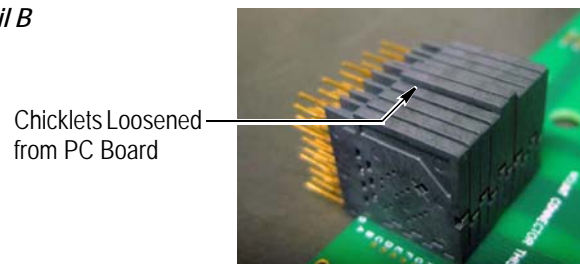

Figure 3 (Cont'd)

Detail C

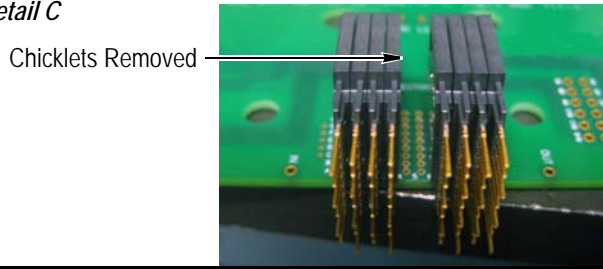

Figure 3 (End)

4. Deflect, and use the needle-nose pliers to remove, each remaining chicklet. See Figure 4.

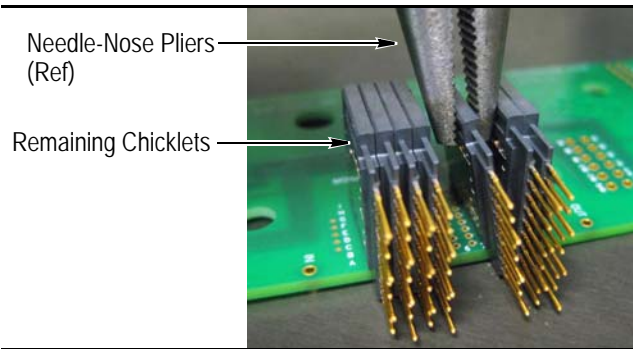

Figure 4

The pc board is ready for the replacement header module.

3.2. Receptacle (Backplane) Module

1. If space allows, use the adjustable pliers to grasp the sides of the housing, and gently rock the housing back and forth while pulling it away from the contacts remaining on the pc board. See Figure 5.

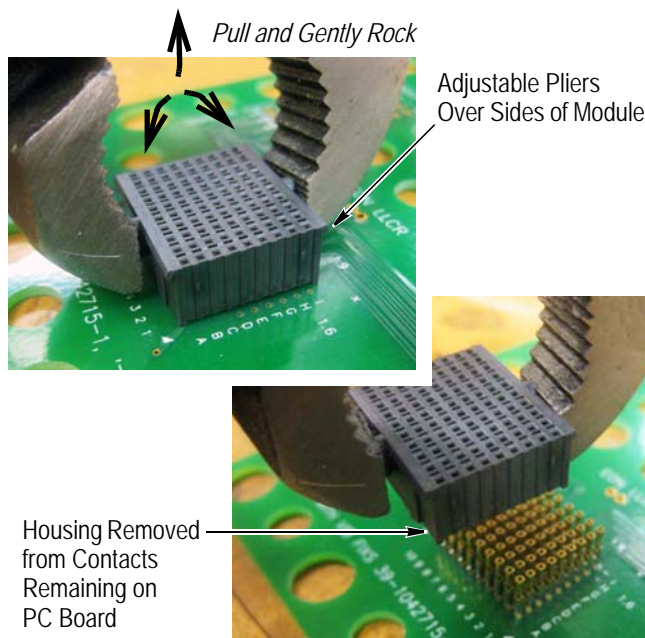

Figure 5

If space *does not* allow, make a tool capable of grasping the alignment lug of the module and pulling it straight away from the contacts. Refer to Figure 6 for recommended tool design.

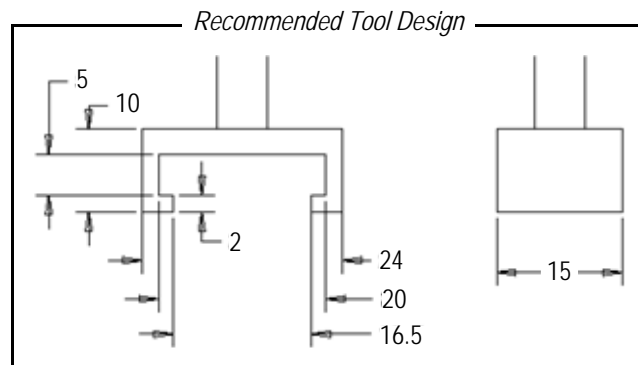
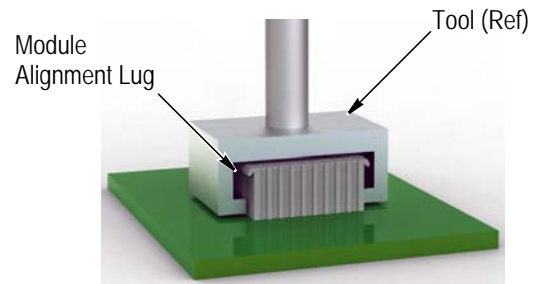

Figure 6

2. Using the needle-nose pliers, remove the contacts one at a time. Refer to Figure 7.

Needle-Nose Pliers Used to Remove Contact from PC Board

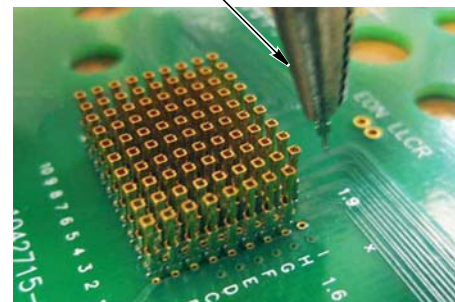

Figure 7

The pc board is ready for the replacement receptacle module.

4. REVISION SUMMARY

Initial release of instruction sheet