

HVS-3-2520S

Splice Series

25kV Class Splice for 3C Extruded Dielectric (Poly/EPR)
Power Cables: Metallic Tape, Wire Shield, UniShield, or
Lead Sheath Cables

ENERGY DIVISION

Suggested Installation Equipment (not supplied with kit)

- Cable preparation tools
- Tyco Electronics P63 cable preparation kit or cable manufacturer approved solvent
- Clean, lint-free cloths
- Non-conducting abrasive cloth, 120 grit or finer
- Electrician's tape
- Connector(s) and installation tools
- Tyco Electronics recommended torch

Safety Instructions

DANGER: When installing electrical power system accessories, failure to follow applicable personal safety requirements and written installation instructions could result in fire or explosion and serious or fatal injuries.

To avoid risk of accidental fire or explosion when using gas torches, always check all connections for leaks before igniting the torch and follow the torch manufacturer's safety instructions.

To minimize any effect of fumes produced during installation, always provide good ventilation of confined work spaces.

As Tyco Electronics has no control over field conditions which influence product installation, it is understood that the user must take this into account and apply his own experience and expertise when installing product.

Recommended Tyco Electronics Torches

Install heat-shrinkable cable accessories with a "clean burning" torch, i.e., a propane torch that does not deposit conductive contaminants on the product.

Clean burning torches include the Tyco Electronics FH-2629, FH-2649 (uses refillable propane cylinders), FH-2618A-1, and FH-2640-PS-kit (uses disposable cylinder).

Adjusting the Torch

Adjust regulator and torch as required to provide an overall 12-inch bushy flame. The FH-2629 will be all blue, the other torches will have a 3- to 4-inch yellow tip. Use the yellow tip for shrinking.

Regulator Pressure

FH-2618A-1	Full pressure
FH-2649	25 psig
FH-2629	15 psig
FH-2640-PS-KIT	Full pressure

General Shrinking Instructions

- Apply outer 3- to 4-inch tip of the flame to heat-shrinkable material with a rapid brushing motion.
- Keep flame moving to avoid scorching.
- Unless otherwise instructed, start shrinking tube at center, working flame around all sides of the tube to apply uniform heat.

To determine if a tube has completely recovered, look for the following, especially on the back and underside of the tube:

1. Uniform wall thickness.
2. Conformance to substrate.
3. No flat spots or chill marks.
4. Visible sealant flow if the tube is coated.

Note: *When installing multiple tubes, make sure that the surface of the last tube is still warm before positioning and shrinking the next tube. If installed tube has cooled, re-heat the entire surface.*

Customer Service

For 24 hour customer service, call 800-327-6996.

UniShield is a trademark of General Cable Technologies Corporation.

Installation Instructions

1. Product selection

Check kit selection with cable diameter dimensions in Table 1.

Note: Table is for 100% insulated cable. For 133% insulated cable, check actual cable dimensions.

Table 1

Kit	Nominal Cable Range	Min. Jacket Diameter	Insulation Diameter Range	Max. Connector Dimensions	
				Diameter	Length
HVS-3-2521S	# 1-250 AWG	1.65" (42mm)	0.90-1.20" (23-30mm)	1.10" (28mm)	4.0" (102mm)
HVS-3-2522S	350-500 kcmil	1.65" (42mm)	1.20-1.50" (30-38mm)	1.35" (34mm)	6.0" (152mm)
HVS-3-2523S	750-1000 kcmil	2.50" (64mm)	1.50-1.80" (38-46mm)	1.85" (47mm)	8.0" (203mm)

2. Check ground braid

Verify that ground braid(s) or bond wire have equivalent cross-section to cable metallic shield. Additional braid may be needed for LC shield, lead sheath cables, or if external grounding or shield interrupting is required.

Tyco Electronics HVS-EG-3 supplies ground braid, spring clamp and suggested modifications to make an external ground or shield interrupt.

3. Prepare cables

Choose the cable type (Choice 1-3) and use the dimensions shown in Table 2 to prepare the cables.

Table 2

Kit	Jacket Cutbacks		Metallic Shield Cutback/ Wire Pullback	Semi-con Cutback
	A1	A2	B	C
HVS-3-2521S	33" (840mm)	19" (485mm)	9" (230mm)	5-1/2" (140mm)
HVS-3-2522S	39" (990mm)	21" (535mm)	10-1/2" (265mm)	6-3/4" (170mm)
HVS-3-2523S	42" (1065mm)	22" (560mm)	12" (305mm)	7-3/4" (195mm)

Choice 1

If Metallic Tape Shield

Refer to Table 2 and prepare the cables as shown. Remove any fillers to the armor cutback. Bend back the grounding conductor(s) over the jacket as shown.

Go to Step 4, page 3.

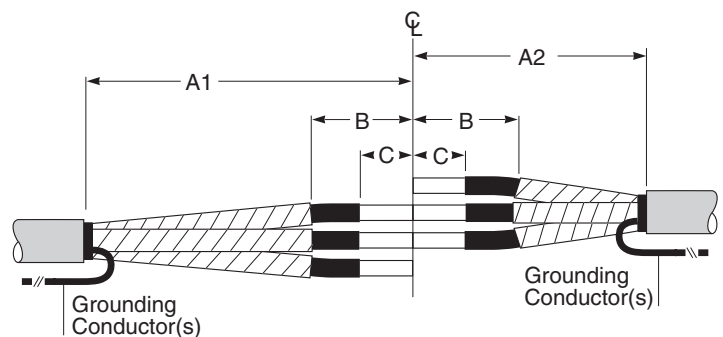

694

Choice 2

If Drain Wire Shield Cable

Refer to Table 2 and prepare the cables as shown. Remove any fillers to the armor cutback. Pull drain wires back to Dimension B and temporarily tape over ends as shown. Bend back the grounding conductor(s) over the jacket as shown.

Go to Step 4, below.

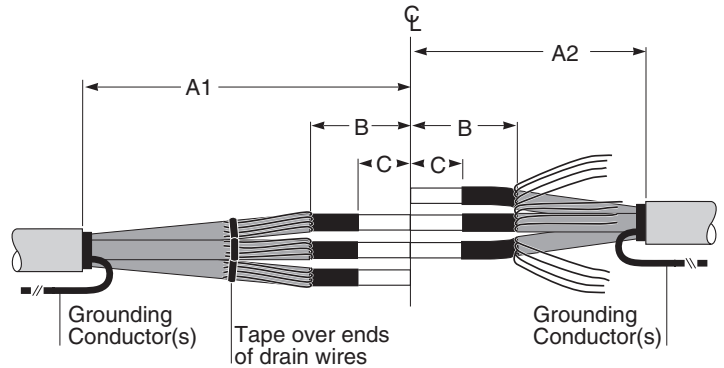

695

Choice 3

If UniShield Cable

Refer to Table 2 and prepare the cables as shown. Remove any fillers to the armor cutback. Pull drain wires back to Dimension B and temporarily tape over ends as shown. Bend back the grounding conductor(s) over the jacket as shown.

Go to Step 4, below.

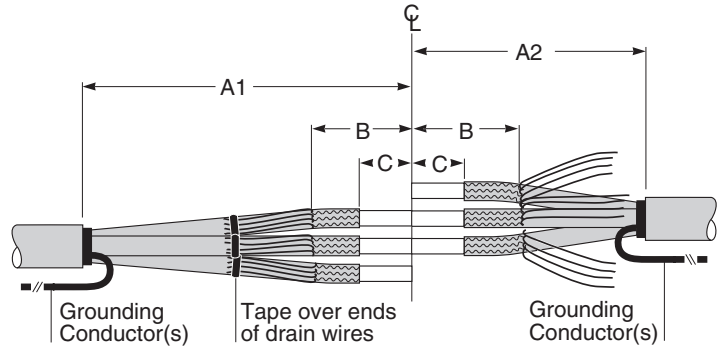

696

4. Remove insulation

Refer to Table 3 and the cutback insulation as shown.

Note: For ShearBolt Connectors, do not leave an expansion gap (X).

Table 3

Kit	Maximum Connector Dimensions		Expansion Gap "X"
	Length	Diameter	
HVS-3-2521S	4" (102mm)	1.10" (28mm)	1/4" (5mm)
HVS-3-2522S	6" (152mm)	1.35" (34mm)	1/2" (10mm)
HVS-3-2523S	8" (203mm)	1.85" (47mm)	1/2" (10mm)

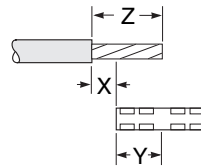

$$\text{"Z" Insulation Cutback} = \text{"X" Expansion Gap} + \frac{1}{2} \text{"Y" Length of Connector}$$

400

5. Abrade insulation

Abrade the insulation, if necessary, to remove imbedded semi-con and clean as shown.

Note: Metallic tape shield to metallic tape shield splice is shown but any combination of the types discussed above will work.

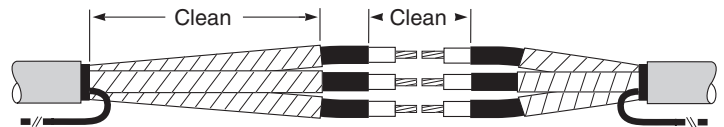

697

6. Place nested tubes over phases

Place one set of nested tubes over each phase as shown.

Protect tubes from end of conductor as they are placed over cable end.

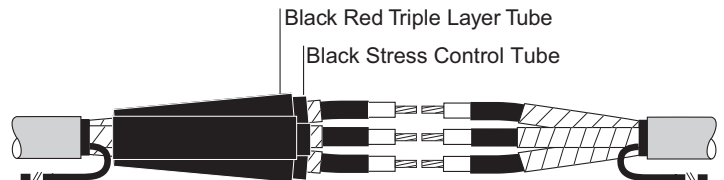

698

7. Install connector

After installation, deburr connector.

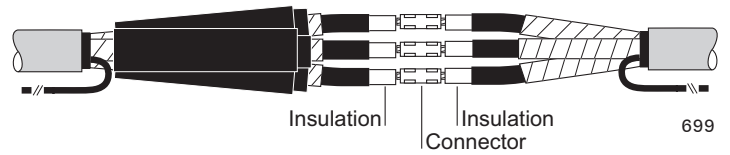

8. Apply SRM over connector

Complete Steps 8-10 working on one phase at a time.

Clean connector area and insulation, as shown, using an approved solvent.

Remove backing from one side of the long strip of Stress Relief Material (SRM). Roll the SRM and remaining backing strip into a convenient size. Remove the remaining backing strip and tightly wrap the SRM around the connector and exposed conductor. Be sure to fill the gaps and low spots around the connector.

Continue to wrap SRM onto the solvent cleaned insulation as shown.

Note: If connector diameter is larger than insulation diameter, apply two half-lapped layers of SRM over the entire connector. Discard any excess SRM (long strips).

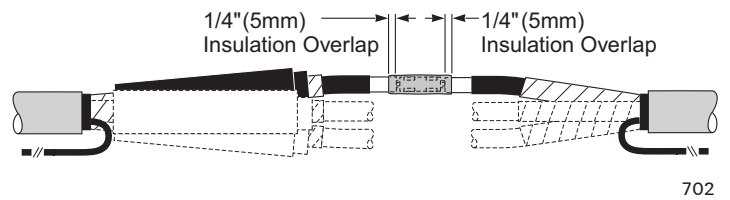
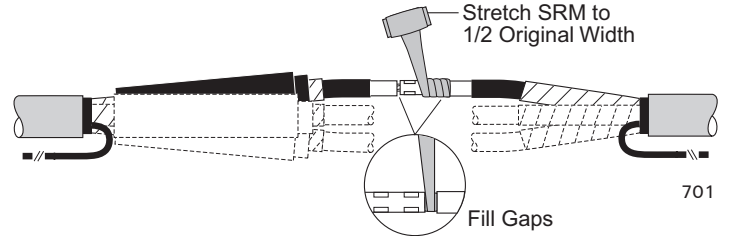
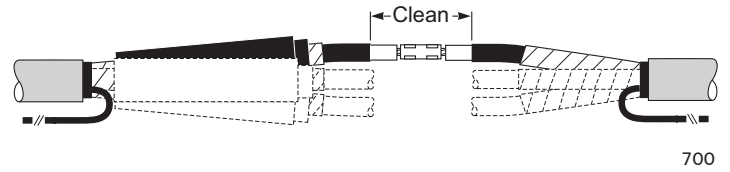

9. Apply SRM at semi-con cutback

Remove backings from the short angle-cut piece of SRM. Place tip of SRM at semi-con cutback and tightly wrap to fill semi-con step. Overlap semi-con and insulation as shown. Taper SRM down to meet insulation.

Note: If using UniShield cable, apply SRM as shown to fill conductive jacket step.

UniShield is a trademark of General Cable Technologies Corporation.

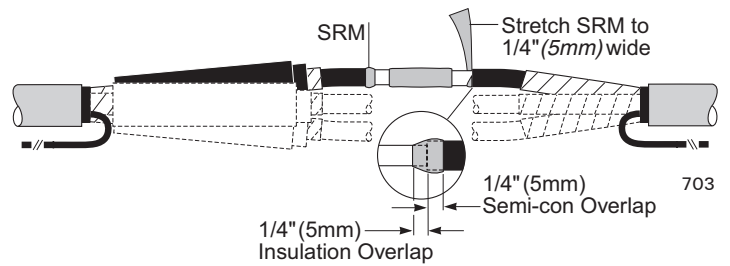

10. Position tube over connection.

Center black stress control tube over completed connector area.

Repeat Steps 8-10 on the remaining phases.

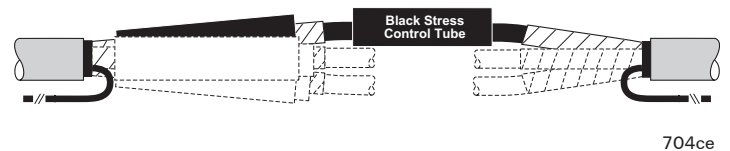

11. Check position of Black Stress Control tubes; shrink in place.

Make sure each tube is centered over the connection area. Shrink all three tubes in place at the same time.

Begin shrinking at center of tube (1), working torch with a smooth, brushing motion around the tube. After center portion shrinks, work torch as before toward one end (2), then to the opposite end (3). Apply sufficient heat to ensure softening of the yellow mastic, indicated by a smooth surface profile.

Note: Do not point the flame directly at the cable semi-con layer.

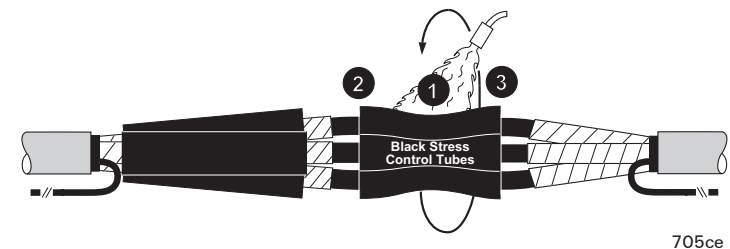

12. Apply red sealant

Remove backing from red sealant. Using light tension, wrap sealant over each cable phase, butted against the tubes as shown. Build the sealant to the level of the black stress control tube.

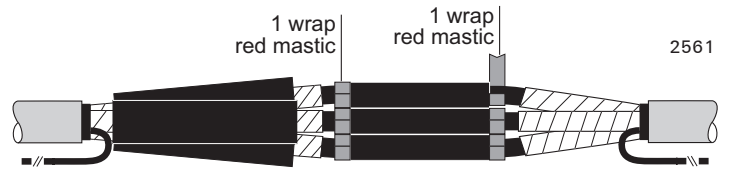

13. Check position of Black/Red Triple Layer tubes; shrink in place

Center the tubes over the splice. Begin shrinking at the center (1) of the tubes, working the torch around all sides of the tubes. After the center portion shrinks, work towards one end (2), then to the opposite end (3). After tubes appear to have fully shrunk, heat the entire tubes for 60 seconds.

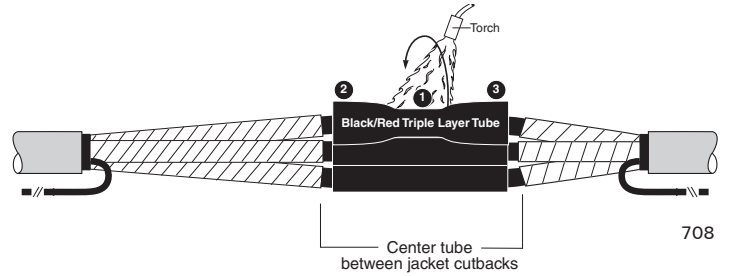

Note: Do not point the flame at the cable semi-con.

14. Install ground

Choose the appropriate cable type (Choice 1 and 2) and follow the directions given.

If External Grounding

Refer to Tyco Electronics HVS-EG-3, "Guide for External Grounding of Power Cable Splices" for modifications to these instructions.

Choice 1

If Metallic Tape Shield Cable

(1) Flare one end of the ground braid and place it onto the metallic tape butted up to the installed splice tube. (2) Attach the braid to the shield by placing two wraps of the spring clamp over the braid. (3) Fold the braid back over the spring clamp wraps. Continue to wrap the remaining clamp over the braid. Tighten clamp by twisting it in the direction it is wrapped and secure with copper foil tape provided.

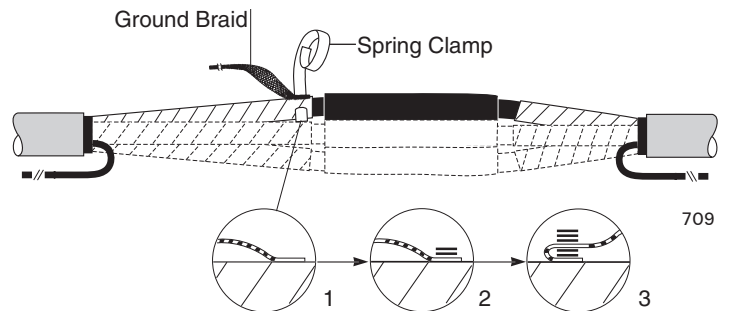

(4) Lay the braid across the splice tube and onto the exposed tape shield on the other side. (5) Make two wraps of the clamp over the braid. (6) Fold the braid back toward the splice and finish wrapping the clamp. Tighten and secure. Cut off excess braid. Repeat Choice 1 for remaining phases.

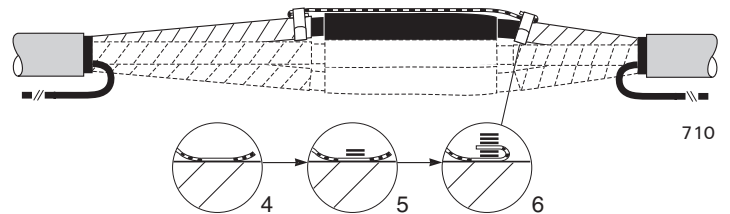

Discard connectors.

Go to Step 15, page 6.

Choice 2

If Drain Wire or UniShield Cable

Pigtail the wires on each side. Crimp the ground braid onto one pigtail with the connector provided.

Lay braids across splice tubes and attach to pigtail on the other side. Cut off excess braid and trim pig-tailed wires. Repeat Choice 2 for remaining phases.

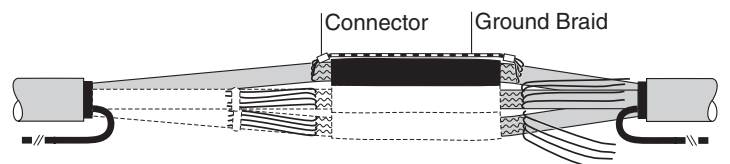

Discard spring clamps and foil tape.

Go to Step 15, page 6.

15. Connect grounding conductor(s)

Bend the grounding conductor(s) back over the tubes and splice with a suitable connector.

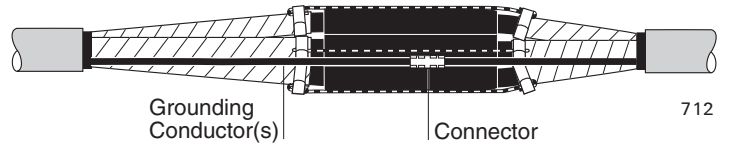

16. Install the shielding mesh

Starting on the cable shields, wrap a half-lapped layer of the mesh around all three phases across the length of the tubes and tie off on the shields at the other side of the splice.

Abrade and solvent clean cable jackets as shown to provide an oil-free surface.

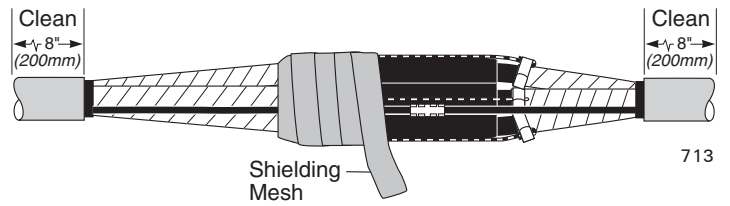

17. Position wraparound sleeve

Remove or tape over all sharp points to prevent puncture of wraparound sleeve. Remove backing from the wraparound sealing sleeve and center sleeve over splice. Clamp the metal retention clip onto the butted rails at the center of the sleeve to hold the sleeve together while channels are installed.

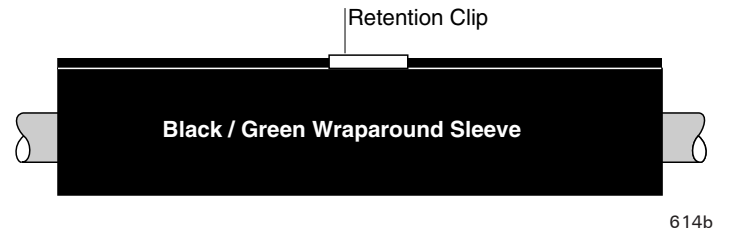

18. Install channels

Connect the channels by overlapping the retention clip as shown at right.

Note: Channels must overlap sleeve edge by 1/4 inch (5mm) minimum.

If channels slide on easily go to step 19. If channel fit seems tight, continue with next paragraph.

As shown in illustration A, make sure flap is not pinched between the rails. Push the sleeve up from the bottom and down from the top while sliding on channel as shown in illustration B. The idea is to flatten the rails together to prevent the channels from binding.

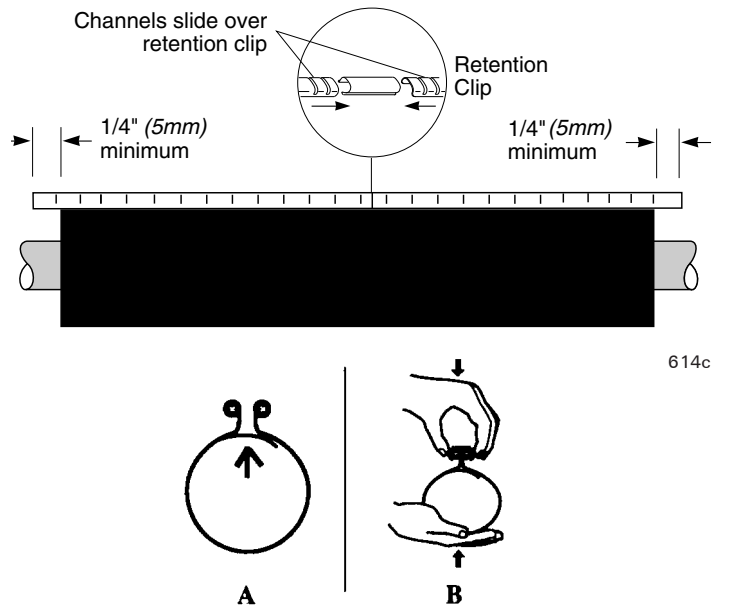

19. Shrink the wraparound sleeve

Preheat evenly along both sides of the rail/channel area until this area begins to shrink. To achieve uniform heating, move the flame back and forth from one side of the channel to the other as shown in illustration "A" while moving flame along the entire length of the channel as shown in illustration "B" until the sleeve starts to shrink. This technique will assure a properly preheated rail and channel area.

Begin shrinking at the center of the sleeve. After shrinking the entire circumference at the center, then work toward each end. Apply heat until the sleeve is fully shrunk and the heat-sensitive green paint is completely converted to black. Continue heating the rail/channel area for another 5 seconds per foot. A white line should be visible in the channel gaps indicating sufficient heating.

Note: Green heat-sensitive paint will turn black as sleeve shrinks in place.

This completes the splice.

Note: Allow to cool before moving or placing in service.

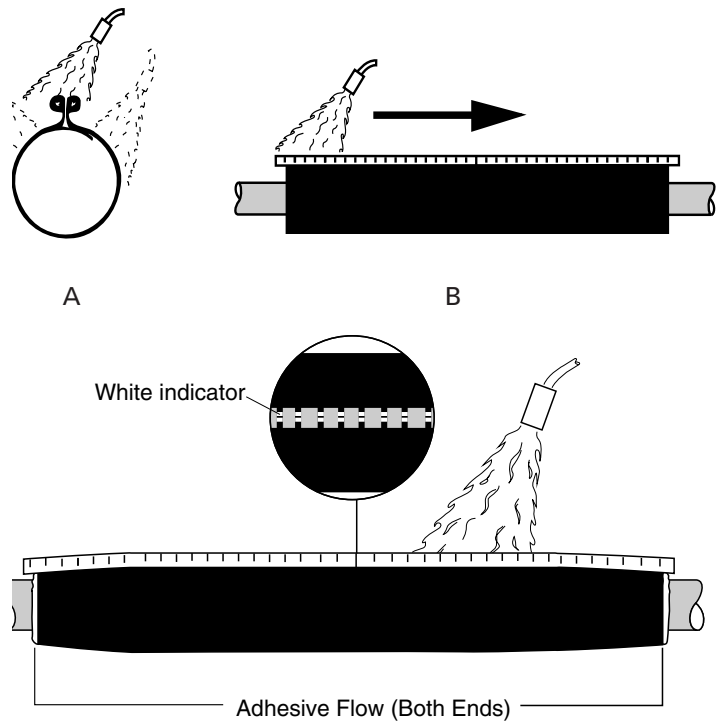

614d

The Information contained in these installation instructions is for use only by installers trained to make electrical power installations and is intended to describe the correct method of installation for this product. However, Tyco Electronics Corporation has no control over the field conditions which influence product installation. It is the user's responsibility to determine the suitability of the installation method in the user's field conditions. Tyco Electronics' only obligations are those in Tyco Electronics' standard Conditions of Sale for this product and in no case will Tyco Electronics be liable for any other incidental, indirect or consequential damages arising from the use or misuse of the products.

TE (logo) and the Tyco Electronics are trademarks Copyright 2002, 2007-2008, 2010 by Tyco Electronics Corporation. All Rights Reserved.