

Figure 1

## 1. INTRODUCTION

These EB jam-nut receptacle connectors are designed to be installed onto simplex cable with a maximum jacket diameter of 1.9 mm.

**NOTE** *Dimensions in this instruction sheet are in metric units. Figures are not drawn to scale.*

The connector must be assembled using a receptacle connector shell kit, an EB insert assembly kit, and ferrule assembly kit (one for each fiber or channel). Sample part numbers are given in Figure 1. The combination of the kits selected is based on the mode and quantity of fibers and the operating wavelength of the system.

**CAUTION** *To avoid poor optical performance or permanent damage to the lens of the EB insert, use ONLY TE Connectivity ferrule assembly kits. Other manufacturers' ferrule assemblies ARE NOT compatible with the EB insert assembly kit.*

These connectors are designed to be rear panel mounted.

Reasons for reissue of this instruction sheet are provided in Section 7, REVISION SUMMARY.

## 2. DESCRIPTION

Each kit contains the components shown in Figure 1.

The EB insert assembly kit is shipped with a white protective label on the back (end opposite the lens) of the EB insert which is installed immediately after final testing to keep the channel cavities clean. The EB insert is ready for assembly as shipped.

## 3. HANDLING

**DANGER** *To avoid personal injury, NEVER look into the end of terminated or unterminated optical fibers. Laser radiation is invisible but can damage eye tissue.*

- Do not touch the lens of the EB insert with your fingers or with any tools

**NOTE** *If the lens is touched or otherwise contaminated, clean the lens according to Instruction Sheet 408-8828.*

- After assembly, re-install the protective cap or mate the connector immediately after the cap has been removed to prevent contamination to the EB insert assembly

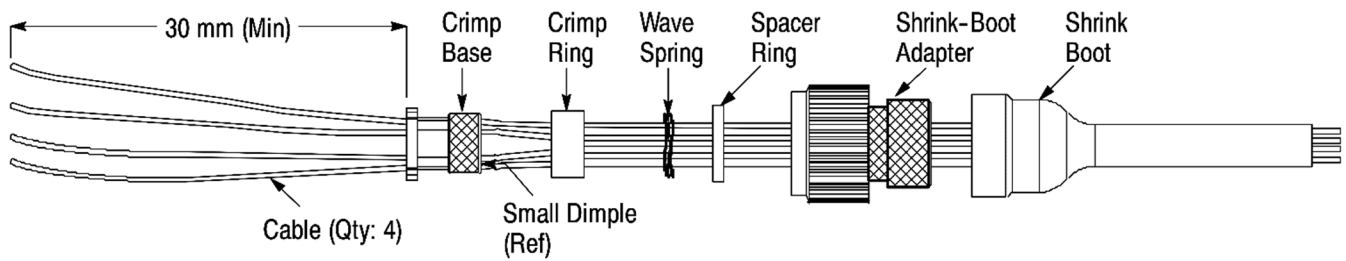
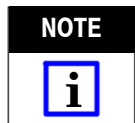

Figure 2

#### 4. TOOLS AND MATERIALS

The following tools and materials are necessary for preparation, assembly, inspection, and maintenance of the connector and cable assembly. Follow the operating instructions packaged with the tools and safety guidelines packaged with the materials.



*Items without a part number or supplier are customer supplied.*

##### 4.1. Tools

- cable jacket strip tool
- Fiber Stripping Tool 1278947-1 (408-4577)
- Heat Cure Oven Assembly 502134-1 (120 Vac) or -2 (240 Vac) includes universal heat cure block (408-9460)
- Curing Fixture 1754122-1 (408-8857)
- Sapphire Scribe Tool 504064-1 (408-4293)
- polishing machine (recommended) or Polishing Bushing 503337-1 (for hand polishing)
- 200x Microscope Kit 1754767-1
- Ferrule Insertion Tool 1693820-1
- 2-mm hex wrench
- power source, power meter, and test cables
- PRO-CRIMPER\* III Hand Crimping Tool Frame 354940-1 (408-9930) or 58532-1 (408-4020)
- Die Set 1804018-1 (408-10022)
- Aramid Shears 1278637-1
- small file
- keyed adapter tool with handle or bench-mount fixture, strap wrench or soft-jawed pliers, and torque wrench or torque stand †
- 27-mm jam-nut socket
- hot air gun

##### 4.2. Materials

- lint-free tissues or cloths
- isopropyl alcohol (99%) or acetone
- EPO-TEK 353ND-T epoxy
- Epoxy Applicator Kit 501473-3

For hand polishing only:

- 5- $\mu$ m Aluminum Oxide Polishing Film 228433-8
- 1mm Rubber Polishing Pad 501858-1 (green)
- 0.3- $\mu$ m Diamond Polishing Film 228433-5
- Final Polishing Film 502748-2

- Loctite 480 instant adhesive
- Loctite 712 accelerator
- abrasive cloth or pad such as Scotch-Brite abrasive pad
- lint-free applicator swabs
- Dow Corning Molykote 55 O-ring grease
- Loctite 243 threadlocker
- Loctite 411 instant adhesive

#### 5. ASSEMBLY PROCEDURE

**IMPORTANT:** Assemble the connector using a laminar flow table in a clean environment meeting the requirements of International Organization for Standardization (ISO) 14644-1 (Class 5), “Cleanrooms and Associated Controlled Environments, Part 1.” Make sure that all components are free from contamination.

Proceed as follows:

##### 5.1. Prepare the Cable

1. Slide the first 5 components shown in Figure 2 onto the 4 cables. Make sure to orient each component as shown. Then insert each cable into a separate hole in the knurled end of the crimp base. Allow at least 30 mm at the end of the cables for stripping.

Loctite and 243 are trademarks of Henkel Corporation.  
 Scotch-Brite is a trademark of 3M Company.  
 Dow Corning and Molykote are registered trademarks of Dow Corning Corporation.

†BETA backshell assembly tools from Daniels Manufacturing Corporation are recommended. For catalog, visit:  
[https://files.dmctools.com/public/catalogues/beta\\_backshell\\_tooling\\_guide\\_o3Vr6l3.pdf](https://files.dmctools.com/public/catalogues/beta_backshell_tooling_guide_o3Vr6l3.pdf)

**NOTE**



The channels for each fiber pair are designated on the mating face of the EB insert with “A1” and “B1”, and “A2” and “B2”. The small dimple on the crimp base indicates fiber pair 1 (located between A1 and B1 on the EB insert). Use the small dimple on the base of the knurled end of the crimp base as a reference for locating fiber pair 1.

2. Using the cable jacket strip tool, strip the jacket of each cable to the dimension shown in Figure 3, exposing the strength members and fiber buffer. Mark the fiber buffer from the stripped end of the jacket to the dimension shown in Figure 3, then using the fiber stripping tool, strip the fiber buffer from the mark to the end of the fiber buffer, exposing the bare fiber.

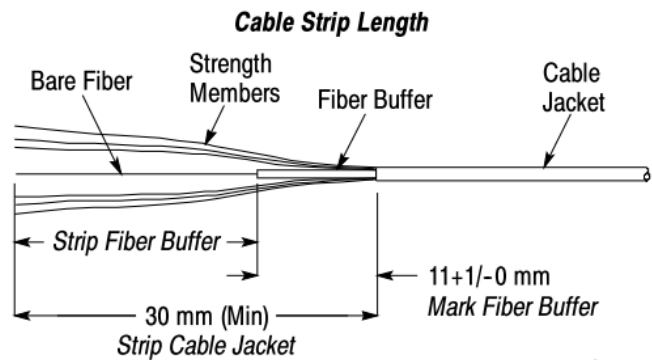

**Note:** Not to Scale

Figure 3

**The following steps describe assembly for one cable.**  
**Perform the same step for each cable.**

3. Using a lint-free tissue or cloth dampened with the isopropyl alcohol or acetone, clean the bare fiber.

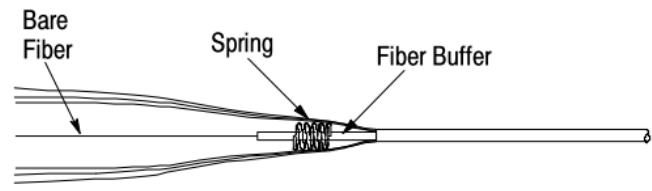

Figure 4

**CAUTION**



Take care not to break the bare fiber.

4. Slide the spring over the bare fiber and onto the buffer. See Figure 4.

5. Pre-heat the heat cure oven to 100°C.

6. Prepare the epoxy according to the following:

a. Remove the separating clip from the epoxy package. Mix the two components together thoroughly for 20 to 30 seconds.

b. Install the needle tip on the applicator from the epoxy applicator kit. Make sure it is secure. Remove the plunger.

c. Cut the epoxy packet open and squeeze the epoxy into the back of the applicator. Re-assemble the plunger. Hold the applicator vertically, and slowly push on the plunger until the entrapped air escapes and a bead of epoxy appears at the needle tip.

d. Using a lint-free tissue or cloth dampened with the isopropyl alcohol or acetone, clean the tip of the applicator.

7. Hold the ferrule assembly vertically, and insert the needle tip into the base of the ferrule assembly until it is against the back (end closest to the base) of the ferrule assembly. Refer to Figure 5.

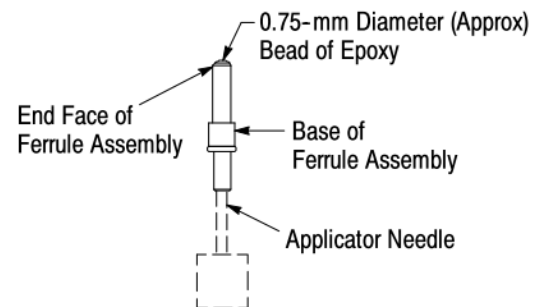

Figure 5

8. While holding the ferrule assembly *firmly* against the needle tip, *slowly* inject the epoxy until a small bead of epoxy (approximately 0.75 mm in diameter) forms at the end face of the ferrule assembly. DO NOT allow the bead to get too large or smear.

9. Withdraw the needle slightly (approximately 2 to 3 mm) and inject an additional small amount of epoxy so that the cavity at the base of the ferrule assembly is approximately one-third to one-half full.



To avoid personal injury, remember that epoxy is a hazardous material, and pay particular attention to the following:

- ALWAYS follow manufacturer’s safety guidelines.
- ALWAYS wear protective gloves when using epoxy.
- ALWAYS use epoxy in a well-ventilated area.
- AVOID prolonged and frequent contact with skin.
- AVOID inhaling fumes from epoxy.

10. Carefully insert the bare fiber into the back of the ferrule assembly (previously prepared with epoxy). Simultaneously slide and rotate the ferrule assembly on the fiber (to prevent any air pockets from being trapped in the epoxy) until it bottoms. Make sure that the bare fiber is protruding from the end face of the ferrule assembly. If it is not, re-strip and re-terminate the cable.

Place the ferrule assembly in the curing fixture according to the instructions included with the curing fixture.

11. Cure the assembly in the heat cure oven for 20 minutes. Remove the assembly from the oven and allow the assembly to cool to room temperature.

**5.2. Cleave the Fiber**

Firmly support the ferrule assembly, and draw the beveled edge of the scribe tool across the fiber as shown in Figure 6. After scoring the fiber, pull the fiber straight away from the ferrule assembly.



Safely dispose of excess fiber.



To avoid damage to the tip of the scribe tool, DO NOT allow the scribe tool to contact the epoxy.

**5.3. Polish the Fiber**

It is recommended polishing the fibers using a polishing machine. Machine polishing will usually produce the best results. Polish the fibers according to the machine manufacturer’s instructions. For best performance, as a minimum the polish should be an SPC (super physical contact) end finish for multimode, and a UPC (ultra physical contact) end finish for singlemode.

If machine polishing is not possible, hand polish the fiber according to the following:

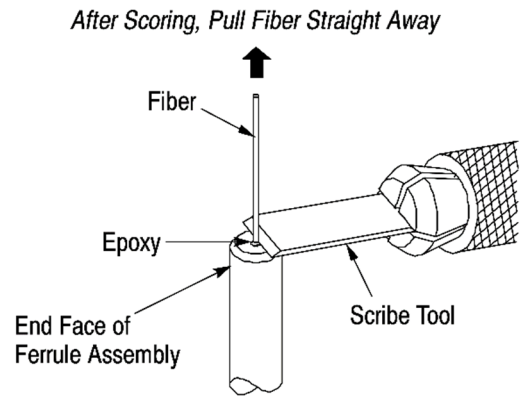

Figure 6

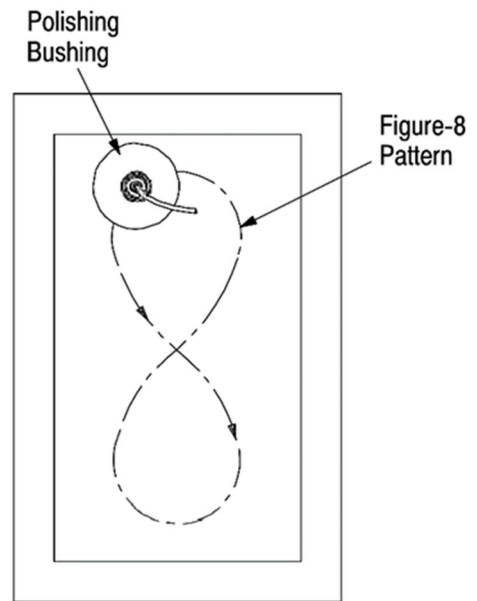

Figure 7

1. Using a small piece of the 5- $\mu$ m polishing film, remove the fiber stub to the level of the epoxy.
2. Install the ferrule assembly onto the polishing bushing.
3. Place the green polishing pad on a hard, flat surface. Place the 5- $\mu$ m polishing film on the polishing pad.
4. Hold the ferrule assembly and rest the tips of your index finger, middle finger, and thumb on the top of the polishing bushing. Starting with very light pressure, polish the tip of the fiber in a figure-8 pattern. Refer to Figure 7. Polish the fiber until the epoxy turns a very light yellow.

**NOTE**



*DO NOT remove all the epoxy. As the epoxy gets lighter, check the tip of the fiber frequently.*

5. Clean the end face of the ferrule assembly and polishing bushing with isopropyl alcohol or acetone and a lint-free tissue.
6. Place the 0.3- $\mu$ m polishing film on the polishing pad. Polish in a figure-8 pattern. Stop polishing as soon as all the epoxy is removed.
7. Clean the end face of the ferrule assembly and polishing bushing with isopropyl alcohol or acetone and a lint-free tissue.
8. Place the final polishing film on the polishing pad. Apply several drops of water to an unused area of the film. Move the ferrule assembly in 20-mm circles on the water for 25 seconds.

**NOTE**



*One sheet of final polishing film will be enough for 10 to 20 ferrule assemblies.*

9. Remove the ferrule assembly from the polishing bushing. Clean the end face and sides of the ferrule assembly with isopropyl alcohol or acetone and a lint-free tissue.

**5.4. Inspect the Ferrule Assembly and Fiber**

**DANGER**



*Never inspect or look into the end of a fiber when optical power is applied to the fiber. The infrared light used, although it cannot be seen, can cause injury to the eyes.*

1. Using the microscope kit, inspect the ferrule assembly and fiber according to the following criteria (refer to Figure 8):
  - Make sure that all epoxy is removed from the ferrule assembly
  - Dirt may be mistaken for small pits. If dirt is evident on the ferrule assembly or fiber, clean with isopropyl alcohol or acetone and a lint-free tissue, then dry
  - Fine polishing lines are acceptable
  - Small peripheral chips (at the outer rim) on the fiber are acceptable
  - Large chips in the center of the fiber and dark scratches are unacceptable, and the fiber must be re-terminated
2. If necessary, install the dust cover onto ferrule assembly to prevent contamination to the end face.

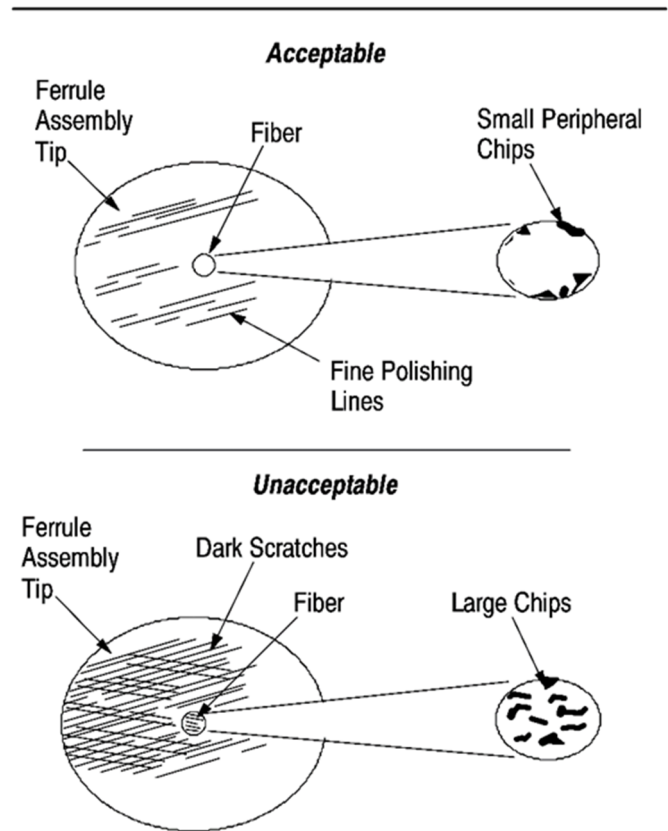

Figure 8



**5.5. Install the EB Insert Assembly**

1. Remove the protective label from the back (end opposite the lens) of the EB insert.
2. Slide the spring onto the ferrule assembly until it is against the O-ring. See Figure 9.

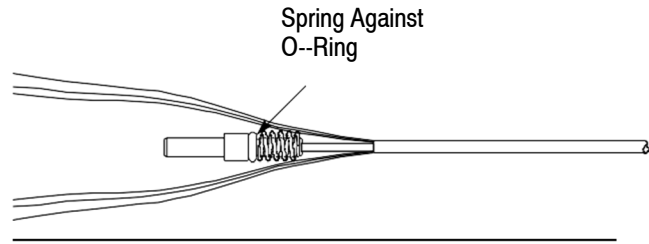

Figure 9

3. Align the end of the ferrule assembly with the appropriate channel cavity of the EB insert, then insert the ferrule assembly into the channel cavity until the O-ring is against the channel cavity. See Figure 10, Detail A. To avoid damage to the fiber, DO NOT push the cable to install the ferrule assembly.

**IMPORTANT:** *The channels for each fiber pair are designated on the EB insert, with “A1” and “B1” as pair 1, and “A2” and “B2” as pair 2. For proper end-to-end system connection, connect A1-to-B1, B1-to-A1, A2-to-B2, and B2-to-A2.*

4. Using the ferrule insertion tool, push on the spring until the ferrule assembly bottoms in the channel cavity (the O-ring will be inside of the cavity, and the spring will protrude slightly from the cavity). See Figure 10, Detail A.

**Detail A**

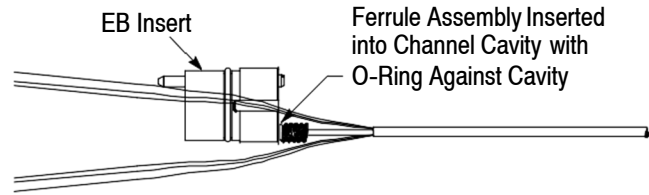

**Using the Ferrule Insertion Tool**

- 1 Place Jaw of Tool Over Spring
- 2 Push Against Spring Until Jaw of Tool Bottoms on EB Insert

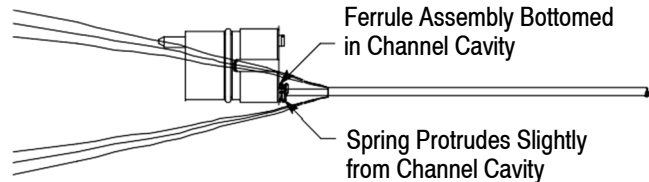

**Detail B**

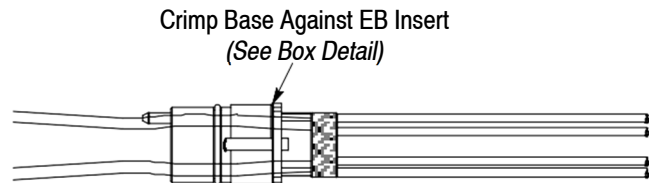

**Box Detail**

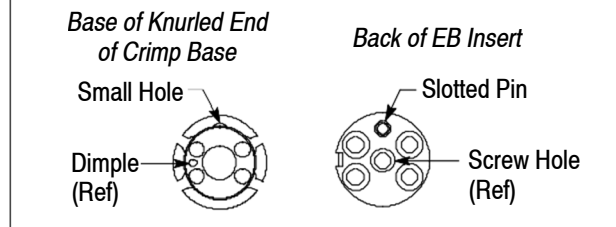

Figure 10

**NOTE**



*The ferrule plate and screw included with the EB insert assembly kit is not needed for assembly of this connector and may be discarded.*

**NOTE**



*If necessary, to remove the ferrule assembly from the cavity, firmly grasp the end of the ferrule assembly (but not the spring) with the needle-nose pliers, and pull it out of the cavity.*

**CAUTION**



*To avoid damage to the fiber, DO NOT PUSH OR PULL ON THE CABLE to install or remove the ferrule assembly from the cavity.*

**The following steps describe assembly for all four cables.**

5. Slide the crimp base over the cables (and strength members) until it is against the springs (in the EB insert) — make sure that the small hole on the flange at the base of the knurled end of the crimp base aligns with the slotted pin at the back of the EB insert. Refer to Figure 10, Detail B.

6. Insert the reduced head screw through the center hole of the crimp base, and thread the reduced head screw into the screw hole of the EB insert. Using the hex wrench and torque wrench or torque stand, tighten the screw to a torque between 0.8 and 1.0 N·m. Check to make sure that the crimp base is flush with the EB insert. See Figure 11, Detail A.

7. Test the assembly for acceptable insertion loss.



*Unacceptable insertion loss must be detected BEFORE proceeding with terminating the fibers. If unacceptable insertion loss is detected AFTER terminating the fibers, the fiber(s) must be re-stripped and re-terminated.*

**5.6. Terminate the Fibers**

1. Fold the strength members back over the knurled end of the crimp base. See Figure 11, Detail B.

2. Slide the crimp ring over the cables (and strength members) and onto the crimp base until it is against the ferrule plate of the crimp base (the strength members will fan out). Refer to Figure 11, Detail C.

3. Uniformly dress all of the strength members around the crimp base. See Figure 11, Detail D.

4. Apply a *thin bead* of the Loctite 480 instant adhesive around the center of the knurled end of the crimp base. Refer to Figure 11, Detail E.

5. Pull the crimp ring onto the center of the knurled end of the crimp base (the strength members will be pressed into the adhesive). See Figure 11, Detail F.

6. Install the die set into the hand tool frame. Place the crimp ring in the nest marked 0.370 on the die, and crimp the crimp ring onto the knurled end of the crimp base. Rotate the crimp ring in the nest by 90 degrees, then crimp the crimp ring again. Refer to Figure 11, Detail G.

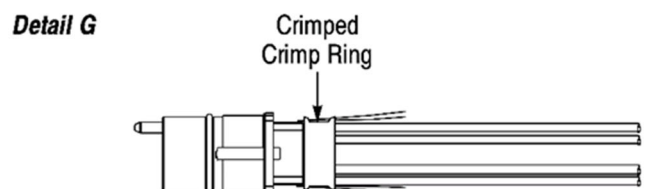
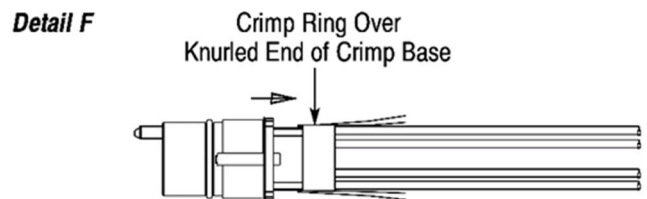
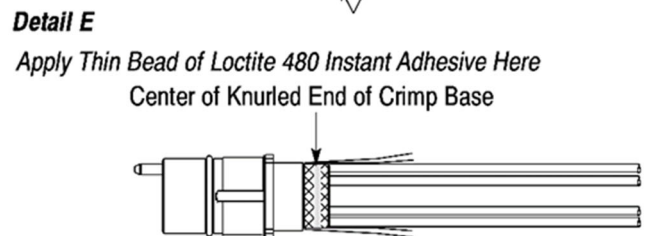
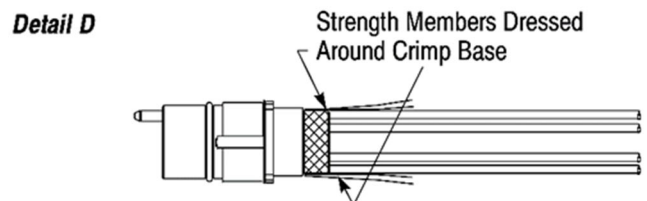
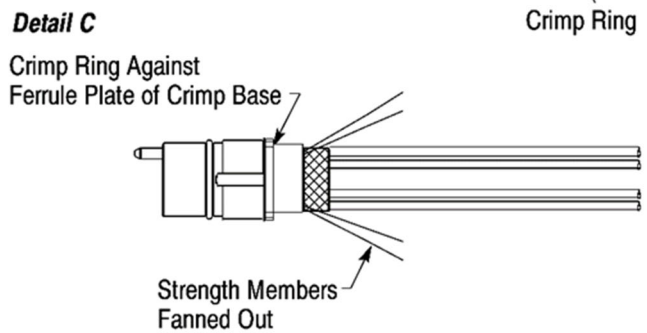
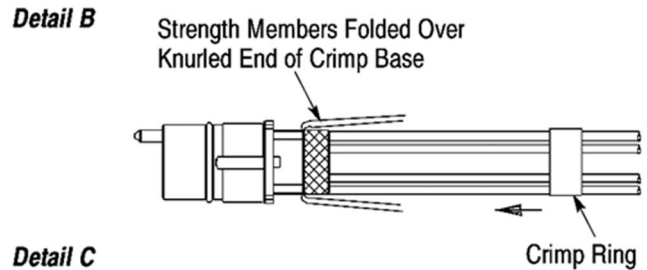
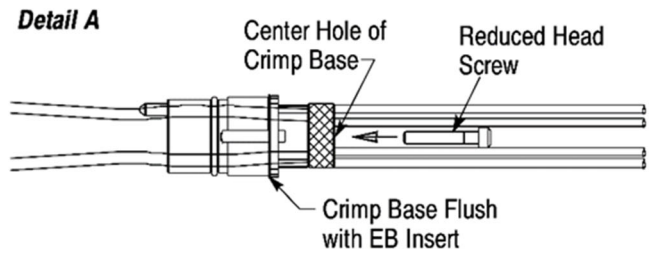



Figure 11

7. Apply a small amount of the Loctite 480 instant adhesive to the strength members at the front of the knurled end of the crimp base. Then apply the accelerator over the instant adhesive to quickly cure the surface of the instant adhesive. The accelerator will turn the surface of the instant adhesive white. See Figure 12, Detail A.

8. Using the shears, trim the strength members as short as possible. See Figure 12, Detail B.

9. Using the syringe (from the epoxy applicator kit), inject a small amount of the Loctite 480 instant adhesive onto the surface of the crimp base where the cables exit (refer to Figure 12, Detail C) and into each channel cavity of the crimp base (refer to Figure 12, Detail D). Then apply the accelerator over the instant adhesive to quickly cure the surface of the instant adhesive. The accelerator will turn the surface of the instant adhesive white.

**NOTE**  *The instant adhesive should encapsulate the buffered fiber in each channel cavity and prevent it from buckling when the cable jacket shrinks during temperature cycling.*

10. Using the small file, remove any burrs (resulting from the crimping operation) from the surface of the crimp ring. Then using the abrasive cloth (or pad), rub the crimp ring until the crimp ring is smooth. Refer to Figure 12, Detail E. Also, make sure that no strength member nor adhesive protrudes above the crimp ring.

**Detail A**

*Apply Small Amount of Loctite 480 Instant Adhesive, Then Accelerator Here*

Strength Members at Knurled End of Crimp Base



**Detail B**

Strength Members Trimmed

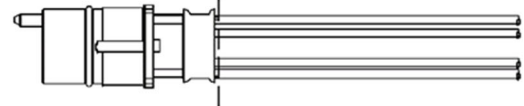

**Detail C**

*Inject Small Amount of Loctite 480 Instant Adhesive, Then Accelerator Here*

Surface of Crimp Base Where Cables Exit



**Detail D**

*Inject Small Amount of Loctite 480 Instant Adhesive, Then Accelerator Here*

Each Channel Cavity (4 Places) of Crimp Base



**Detail E**

*Remove Any Burrs from Surface of Crimp Ring*



Figure 12

**5.7. Complete the Assembly**

1. Slide the wave spring over the cables and the crimp ring (there will be some resistance) until it is against the ferrule plate of the crimp base. See Figure 13.

2. Slide the spacer ring over the cables and the crimp ring until it is against the wave spring. See Figure 13.

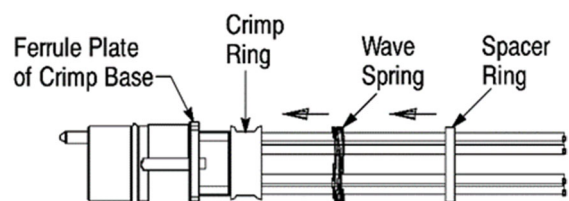

Figure 13



3. Using an applicator swab, apply a *thin film* of the grease around the O-ring of the EB insert. Refer to Figure 14, Detail A.



To avoid contaminating optical components, **DO NOT** use heavy deposits of the grease.

4. Mount the housing onto the keyed adapter tool or bench-mount fixture. Align the internal key (small bar inside) of the housing with the keyway (slot along the side) of the EB insert, then slide the EB insert partially into the housing. See Figure 14, Detail B.

5. Using the hex wrench, push the EB insert assembly into the housing until it bottoms (there will be a tactile “click” as the O-ring of the EB insert assembly compresses and the insert seats into place in the housing). To avoid damage to the fiber, **DO NOT** push the fiber or cable to install the EB insert assembly.

6. Apply several drops of the threadlocker to the threads at the back of the flange of the housing. See Figure 14, Detail C.

7. Thread the shrink-boot adapter onto the housing. Using the strap wrench or soft-jawed pliers and torque wrench or torque stand, tighten the shrink-boot adapter to a torque between 5 and 6 N·m.

8. Remove the housing from the keyed adapter tool or bench-mount fixture.

9. Apply a bead of the Loctite 411 instant adhesive around the large knurl of the shrink-boot adapter. See Figure 14, Detail D.

10. Slide the shrink boot over the shrink-boot adapter until it is against the large diameter end of the shrink-boot adapter. See Figure 14, Detail D.

11. Using the hot air gun, apply heat, first evenly around the circumference of the large diameter end of the shrink boot, then continue along the length of the shrink boot until the shrink boot conforms to the cable. Keep the shrink boot straight until it is completely cooled. Refer to Figure 14, Detail E.

**Detail A**

Apply Thin Film of Grease Here  
O-Ring of EB Insert

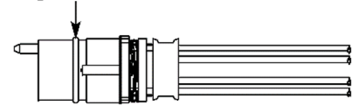

**Detail B**

Internal Key of Housing

Keyway of EB Insert

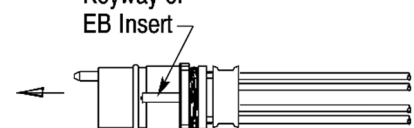
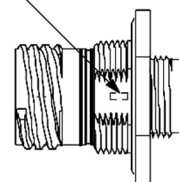

**Detail C**

Apply Threadlocker Here  
Threads at Back of Flange of Housing

Shrink-Boot Adapter

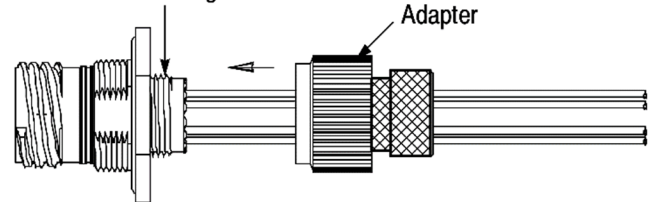

**Detail D**

Apply Bead of Instant Adhesive Here  
Large Knurl of Shrink-Boot Adapter

Shrink Boot

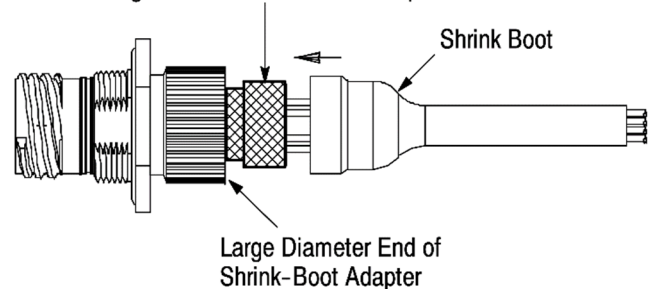

**Detail E**

Apply Heat Here First

Keep Shrink Boot Straight

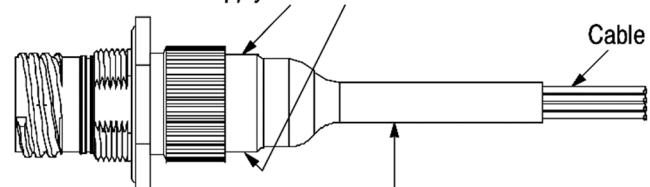
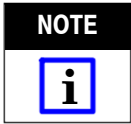

Figure 14

**5.8. Mount the Connector onto the Panel and Install the Protective Cap**

1. Cut the panel using the dimensions provided in Figure 15.



*Make sure that the flat edge is located in position to match the established rotational orientation.*

2. Make sure that the flange O-ring is installed in the groove of the housing flange (refer to Figure 1). Then, install the connector through the back of the panel so that the O-ring on the shoulder of the housing is flat against the panel. See Figure 16, Detail A.

3. Slide the loop of the tether of the protective cover over the threads at the front of the flange of the housing. See Figure 16, Detail A.

4. Thread the jam nut onto the housing. See Figure 16, Detail A. Using the 27-mm jam-nut socket and torque wrench, tighten the jam nut to a torque between 4.5 and 5.2 N·m (40-46 in·lb.). The O-ring will now be compressed.

5. Thread the protective cap onto the housing. Hand-tighten the protective cap. See Figure 16, Detail B.

**6. REPLACEMENT AND REPAIR**

Kit components are not repairable. DO NOT use any damaged or defective components. DO NOT attempt to re-use the crimp support, crimp sleeve, or ferrule assembly by removing the fiber.

Order replacement parts through your TE Connectivity representative, or call 1-800-522-6752, or use the LIVE CHAT on the [www.te.com](http://www.te.com) website.

**7. REVISION SUMMARY**

Revisions to this instruction sheet include:

- Updated document to current corporate requirements
- Section 4.1: updated fiber stripping tool and polishing bushing p/n's, removed epoxy p/n and replaced with recommended epoxy type, removed polishing plate, updated BETA trademark information and website address for BETA backshell tools from DMC
- Section 5.4: revised singlemode/multimode polish requirements and Steps 3, 6, and 8
- Section 5.8: Corrected jam nut torque value and added jam nut to Figure 16, Detail B

**Recommended Panel Cutout**

Panel Thickness Range 1.58-3.2 mm

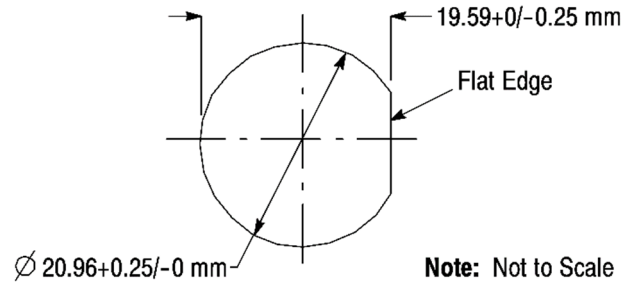

**Note:** Not to Scale

Figure 15

**Detail A**

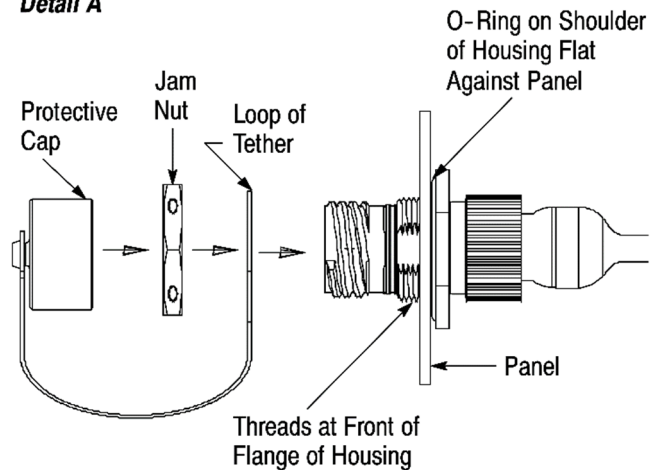

**Detail B**

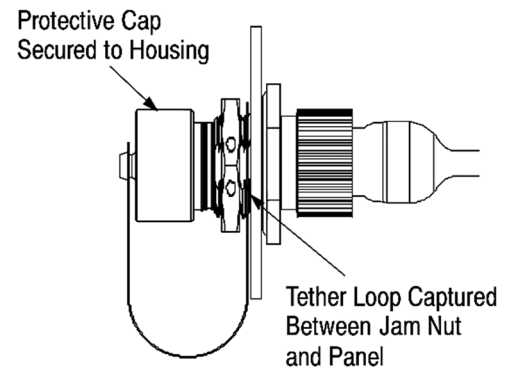

Figure 16