

Figure 1

## 1. INTRODUCTION

PRO BEAM Mini EB sealed D-hole bulkhead connectors are designed to be installed onto jacketed fiber optic cable with aramid strength members.



*Dimensions in this instruction sheet are in metric units. Figures are not drawn to scale.*

The connector must be assembled using a bulkhead connector shell kit, an EB insert assembly kit, ferrule assembly kit (one for each fiber or channel), and a cable adapter kit. Sample part numbers are given in Figure 1. The combination of the kits selected is based on the diameter of the cable, the mode and quantity of fibers, and the operating wavelength of the system.



*To avoid poor optical performance or permanent damage to the lens of the EB insert, use ONLY TE Connectivity ferrule assembly kits. Other manufacturers' ferrule assemblies ARE NOT compatible with the EB insert assembly kit.*

Reasons for reissue of this instruction sheet are provided in Section 7, REVISION SUMMARY.

These connectors are designed to be rear panel mounted.

## 2. DESCRIPTION

Each kit contains the components shown in Figure 1.

The EB insert assembly kit is shipped with a white protective label on the back (end opposite the lens) of the EB insert which is installed immediately after final testing to keep the channel cavities clean. The EB insert is ready for assembly as shipped.

## 3. HANDLING



*To avoid personal injury, NEVER look into the end of terminated or unterminated optical fibers. Laser radiation is invisible but can damage eye tissue.*

- Do not touch the lens of the EB insert with your fingers or with any tools

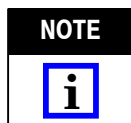

*If the lens is touched or otherwise contaminated, clean the lens according to Instruction Sheet 408-8828.*

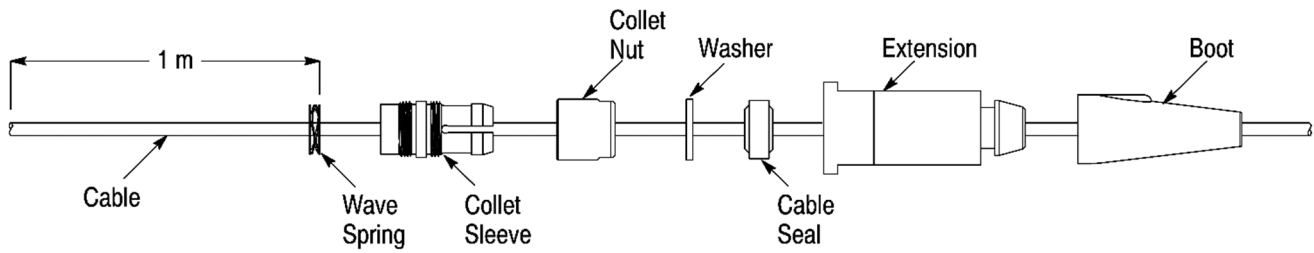
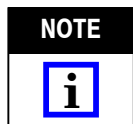

Figure 2

- After assembly, re-install the protective cap or mate the connector immediately after the cap has been removed to prevent contamination to the EB insert assembly

#### 4. TOOLS AND MATERIALS

The following tools and materials are necessary for preparation, assembly, inspection, and maintenance of the connector and cable assembly. Follow the operating instructions packaged with the tools and safety guidelines packaged with the materials.



Items without a part number or supplier are customer supplied.

##### 4.1. Tools

- cable jacket strip tool
- Aramid Shears 1278637-1
- SDE PEW 12 Hand Tool 91382-1 with Die Set 1673667-1 (408-8795)
- micrometer or vernier, dial, or digital caliper
- Fiber Stripping Tool 1278947-1 (408-4577)
- Heat Cure Oven Assembly 502134-1 (120 Vac) or -2 (240 Vac) includes universal heat cure block (408-9460)
- Curing Fixture 1918023-1 (408-8857)
- Sapphire Scribe Tool 504064-1 (408-4293)
- polishing machine (recommended) or Polishing Bushing 503337-1 (for hand polishing)
- 200x Microscope 1754767-1
- Ferrule Insertion Tool 1693820-1
- 2-mm hex wrench
- EB Insert Installation Tool 1918255-1
- Bench-Mount Assembly Fixture 1918503-3
- 13-mm open-end wrench
- 16-mm open-end wrench

##### 4.2. Materials

- Loctite 480 instant adhesive
  - lint-free tissues or cloths
  - isopropyl alcohol (99%) or acetone
  - EPO-TEK 353ND-T epoxy
  - Epoxy Applicator Kit 501473-3
- For hand polishing only:
- 5- $\mu$ m Aluminum Oxide Polishing Film 228433-8
  - 1mm Rubber Polishing Pad 501858-1 (green)
  - 0.3- $\mu$ m Diamond Polishing Film 228433-5
  - Final Polishing Film 502748-2
  - lint-free applicator swabs
  - Dow Corning Molykote 55 O-ring grease
  - Loctite 243 Medium-Strength Threadlocker

#### 5. ASSEMBLY PROCEDURE

**IMPORTANT:** Assemble the connector using a laminar flow table in a clean environment meeting the requirements of International Organization for Standardization (ISO) 14644-1 (Class 5), “Cleanrooms and Associated Controlled Environments, Part 1.” Make sure that all components are free from contamination.

Proceed as follows:

##### 1.1. Prepare the Cable

1. Slide the components shown in Figure 2 onto the cable allowing 1 meter at the end of the cable for stripping the cable. Make sure to orient each component as shown.
  2. Using the cable jacket strip tool, strip the jacket to the dimension shown in Figure 3, exposing the strength members and fiber. Retain the stripped piece of jacket for later use.
- Using the shears, trim the strength members to the length given in Figure 3.

Loctite, 480, and 243 are trademarks of Henkel Corporation.  
 Dow Corning and Molykote are registered trademarks of Dow Corning Corporation.  
 EPO-TEK is a trademark of Epoxy Technology Inc.

**Cable Strip Length**

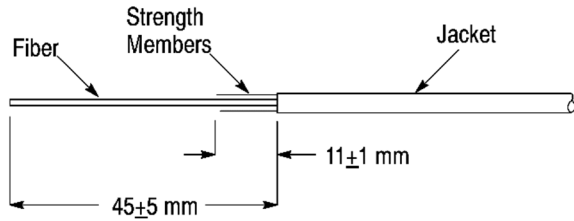

**Note:** Not to Scale

Figure 3

**NOTE**



These instructions are for single-channel connectors. For multi-channel connectors, perform the same assembly procedure for each channel.

**5.1. Terminate the Fiber**

1. Apply a continuous bead of the instant adhesive around the cable jacket between 4 and 5 mm from the stripped end of the jacket. See Figure 4, Detail A.

**NOTE**



LOCTITE 480 Instant Adhesive is a cyanoacrylate which hardens very quickly.

2. Rotate and slide the crimp support (large-diameter end first) over the fiber and strength members and onto the jacket until it bottoms (rotating the crimp support between the thumb and index finger will help feed the strength members through the crimp support). See Figure 4, Detail B.

3. Apply a thin band of the instant adhesive around the knurled portion of the crimp support. Make sure that the band is continuous around the entire circumference. See Figure 4, Detail C.

4. Slide the piece of cable jacket (stripped from the cable in Paragraph 5.1) over the buffered fiber and into the center of the strength members until it bottoms against the crimp support and the strength members are fanned away from the fiber. See Figure 4, Details D and E.

5. Slide the crimp sleeve over the fiber and piece of cable jacket so that the strength members fold back evenly around and over the crimp support and until it bottoms on the rear flange of the crimp support; then remove the piece of cable jacket. This step should be performed quickly before the adhesive begins to harden. See Figure 4, Detail E.

6. Remove the piece of cable jacket.

**Detail A**

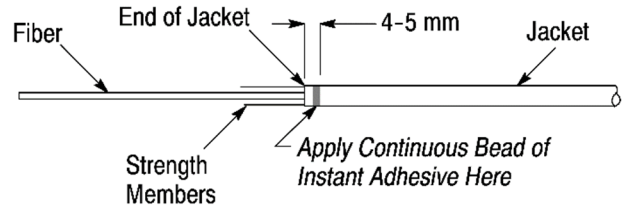

**Detail B**

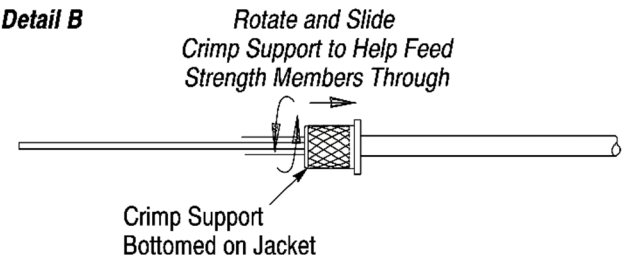

**Detail C**

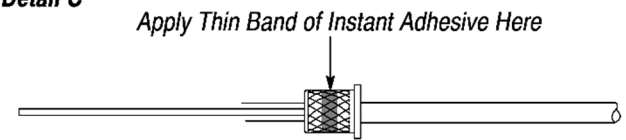

**Detail D**

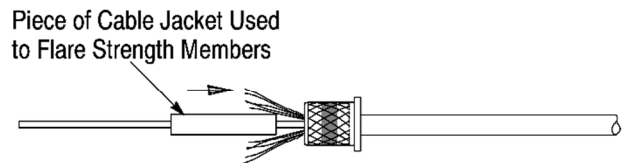

**Detail E**

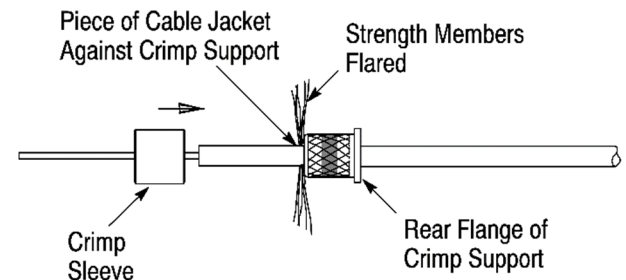

Figure 4

7. Place the crimp sleeve in the 8.6-mm hex nest of the hand tool, and crimp the crimp sleeve onto the crimp support. Make sure to position the crimp sleeve in the hex nest so that the crimp will locate from the back of the crimp sleeve to within the dimension shown in Figure 5, Detail A.

8. Using the micrometer or caliper, measure the crimp sleeve across the flats of the hex crimp to make sure that it conforms to the crimp height and crimp width shown in Figure 5, Detail B. If necessary, crimp again, and re-measure the crimp.

9. At the back of the crimp support, apply the instant adhesive around the circumference of the crimp support at the junction of the cable and the crimp support. Then at the front of the crimp sleeve, apply the instant adhesive over the opening of the crimp sleeve to encapsulate the strength members. See Figure 5, Detail C. Remove any excess adhesive.

10. Mark the fiber at the dimension shown in Figure 5, Detail D, and using the fiber stripping tool, strip the buffer to the mark, exposing the bare fiber. Using a lint-free tissue or cloth dampened with the isopropyl alcohol or acetone, clean the bare fiber.



**CAUTION** Take care to not break the bare fiber. If any part of the fiber breaks, the crimp support and crimp sleeve must be replaced, and the cable must be re-stripped.

11. Slide the spring onto the fiber buffer. See Figure 5, Detail E.

12. Pre-heat the heat cure oven to 100°C.

13. Prepare the epoxy according to the following:

a. Remove the separating clip from the epoxy package. Using the epoxy mixer, mix the two components together thoroughly for 20 to 30 seconds.

b. Install the needle tip on the applicator from the epoxy applicator kit. Make sure it is secure. Remove the plunger.

c. Cut the epoxy packet open and squeeze the epoxy into the back of the applicator.

Re-assemble the plunger. Hold the applicator vertically, and slowly push on the plunger until the entrapped air escapes and a bead of epoxy appears at the needle tip.

d. Using a lint-free tissue or cloth dampened with the isopropyl alcohol or acetone, clean the tip of the applicator.

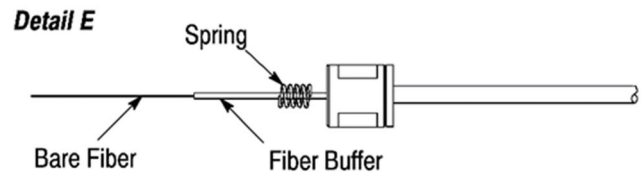
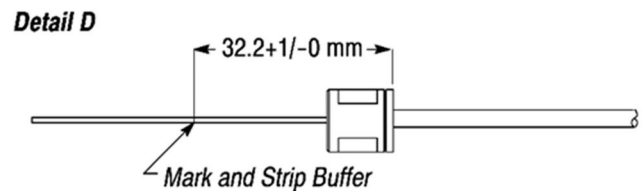
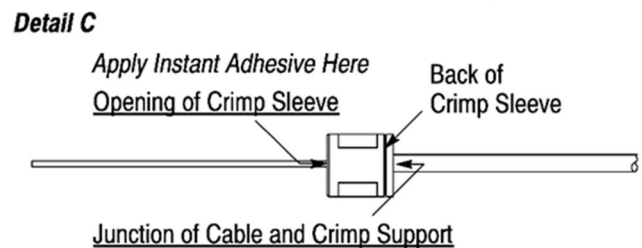
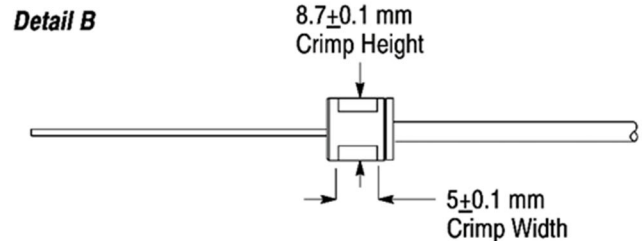
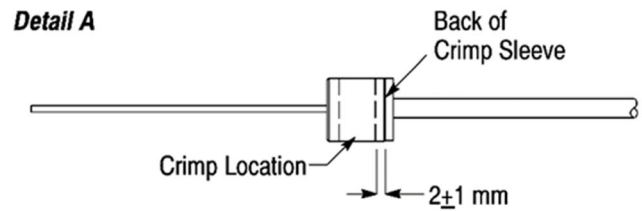

Figure 5

14. Hold the ferrule assembly vertically, and insert the needle tip into the base of the ferrule assembly until it is against the back (end closest to the base) of the ferrule assembly. Refer to Figure 6.

15. While holding the ferrule assembly *firmly* against the needle tip, *slowly* inject the epoxy until a small bead of epoxy (approximately 0.75 mm in diameter) forms at the end face of the ferrule assembly. DO NOT allow the bead to get too large or smear.

16. Withdraw the needle slightly and inject an additional small amount of epoxy so that the cavity at the base of the ferrule assembly is approximately one-third to one-half full.

**DANGER**



To avoid personal injury, remember that epoxy is a hazardous material, and pay particular attention to the following:

- ALWAYS follow manufacturer’s safety guidelines.
- ALWAYS wear protective gloves when using epoxy.
- ALWAYS use epoxy in a well-ventilated area.
- AVOID prolonged and frequent contact with skin.
- AVOID inhaling fumes from epoxy.

17. Place the crimp sleeve and fiber into the curing fixture according to the instructions included with the curing fixture.

Carefully insert the fiber into the back of the ferrule assembly (previously prepared with epoxy). Simultaneously slide and rotate the ferrule assembly on the fiber (to prevent any air pockets from being trapped in the epoxy) until it bottoms.

Make sure that the bare fiber is protruding from the end face of the ferrule assembly. If it is not, re-strip and re-terminate the fiber.

Place the ferrule assembly in the curing fixture according to the instructions included with the curing fixture.

18. Cure the assembly in the heat cure oven for 20 minutes. Remove the assembly from the oven and allow the assembly to cool to room temperature.

19. Measure the assembly to make sure that it conforms to the dimension given in Figure 7. If it does not, re-strip and re-terminate the fiber.

**NOTE**



Although the curing fixture is designed to ensure that the required functional length is obtained, it is still important to measure the assembly for this length after curing.

**5.2. Cleave the Fiber**

Firmly support the ferrule assembly, and draw the beveled edge of the scribe tool across the fiber as shown in Figure 8. After scoring the fiber, pull the fiber straight away from the ferrule assembly.

**DANGER**



Safely dispose of excess fiber.

**CAUTION**



To avoid damage to the tip of the scribe tool, DO NOT allow the scribe tool to contact the epoxy.

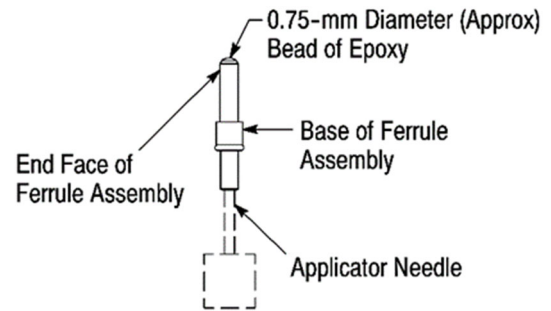

Figure 6

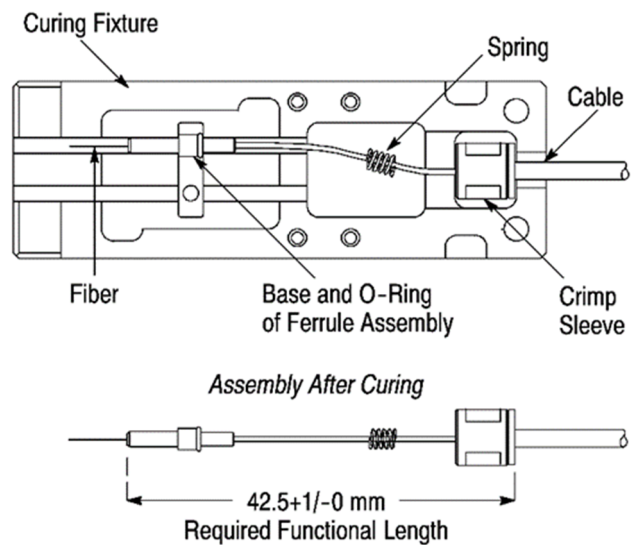

Figure 7

After Scoring, Pull Fiber Straight Away

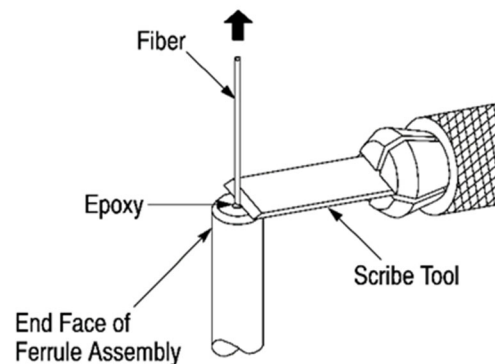

Figure 8



### 5.3. Polish the Fiber

It is recommended polishing the fibers using a polishing machine. Machine polishing will usually produce the best results. Polish the fibers according to the machine manufacturer's instructions. For best performance, as a minimum the polish should be an SPC (super physical contact) end finish for multimode, and a UPC (ultra physical contact) end finish for singlemode.

If machine polishing is not possible, hand polish the fiber according to the following:

1. Using a small piece of the 5- $\mu$ m polishing film, remove the fiber stub to the level of the epoxy.
2. Install the ferrule assembly onto the polishing bushing.
3. Place the green polishing pad on a hard, flat surface. Place the 5- $\mu$ m polishing film on the polishing pad.
4. Hold the ferrule assembly and rest the tips of your index finger, middle finger, and thumb on the top of the polishing bushing. Starting with very light pressure, polish the tip of the fiber in a figure-8 pattern. Refer to Figure 9. Polish the fiber until the epoxy turns a very light yellow.

**NOTE**  
 *DO NOT remove all the epoxy. As the epoxy gets lighter, check the tip of the fiber frequently.*

5. Clean the end face of the ferrule assembly and polishing bushing with isopropyl alcohol or acetone and a lint-free tissue.
6. Place the 0.3- $\mu$ m polishing film on the polishing pad. Polish in a figure-8 pattern. Stop polishing as soon as all the epoxy is removed.
7. Clean the end face of the ferrule assembly and polishing bushing with isopropyl alcohol or acetone and a lint-free tissue.
8. Place the final polishing film on the polishing pad. Apply several drops of water to an unused area of the film. Move the ferrule assembly in 20-mm circles on the water for 25 seconds.

**NOTE**  
 *One sheet of final polishing film will be sufficient for 10 to 20 ferrule assemblies.*

9. Remove the ferrule assembly from the polishing bushing. Clean the end face and sides of the ferrule assembly with isopropyl alcohol or acetone and a lint-free tissue.

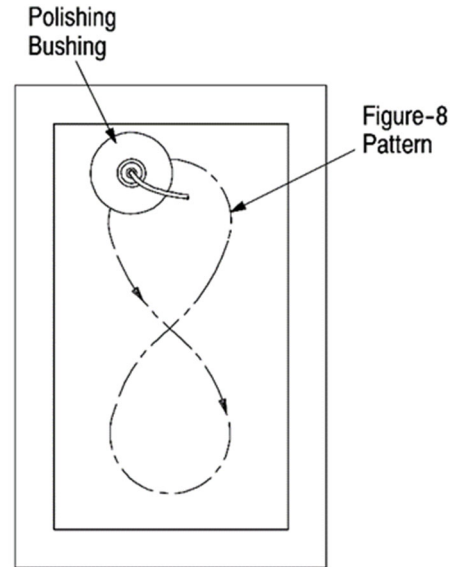



Figure 9

### 5.4. Inspect the Ferrule Assembly and Fiber

**DANGER**  
 *Never inspect or look into the end of a fiber when optical power is applied to the fiber. The infrared light used, although it cannot be seen, can cause injury to the eyes.*

1. Using the microscope, inspect the ferrule assembly and fiber according to the following criteria (refer to Figure 10):
  - Make sure that any epoxy is removed from the ferrule assembly
  - Dirt may be mistaken for small pits. If dirt is evident on the ferrule assembly or fiber, clean with isopropyl alcohol or acetone and a lint-free tissue, then dry
  - Fine polishing lines are acceptable
  - Small peripheral chips (at the outer rim) on the fiber are acceptable
  - Large chips in the center of the fiber and dark scratches are unacceptable, and the fiber must be re-terminated
2. If necessary, install the dust cover onto ferrule assembly to prevent contamination to the end face.

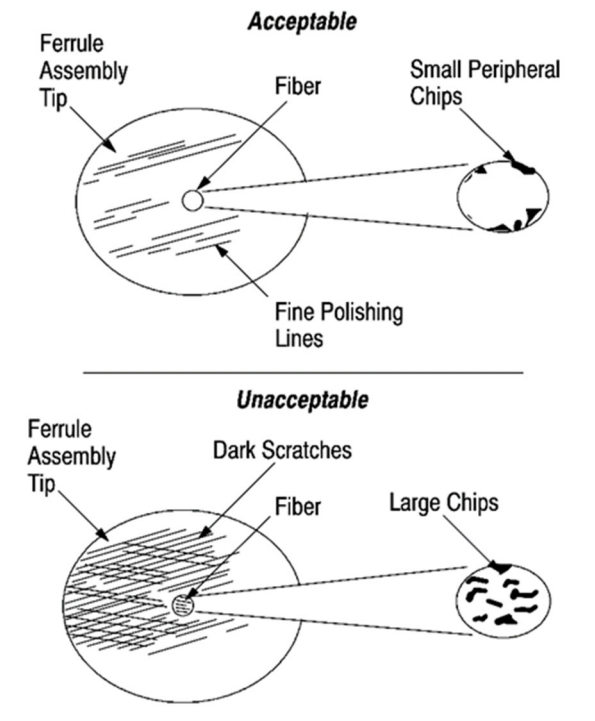



Figure 10

### 5.5. Complete the Assembly

1. Remove the protective label from the back of the EB insert.
2. Align the end of the ferrule assembly with the appropriate channel cavity of the EB insert and insert the ferrule assembly into the channel cavity until the O-ring is against the channel cavity. See Figure 11, Detail A. To avoid damage to the fiber, DO NOT push on the fiber to install the ferrule assembly.

**NOTE**  Because of the short length of the buffered fibers, the ferrule assemblies for multi-fiber connectors **MUST** be inserted into the channel cavities simultaneously.

**IMPORTANT:** The channels for each fiber pair are designated on the EB insert, with “A1” and “B1” as pair 1, and “A2” and “B2” as pair 2. For proper end-to-end system connection, connect A1-to-B1, B1-to-A1, A2-to-B2, and B2-to-A2.

3. Slide the spring over the fiber until it is against the O-ring of the ferrule assembly. See Figure 11, Detail B.
4. Using the ferrule insertion tool, **push on the spring** until the ferrule assembly bottoms in the channel cavity (the spring will protrude slightly from the cavity). See Figure 11, Detail C.

**NOTE**  If necessary, to remove the ferrule assembly from the channel cavity, firmly grasp the end of the ferrule assembly (but not the spring) with the needle-nose pliers, and pull it out of the cavity.

#### Detail A

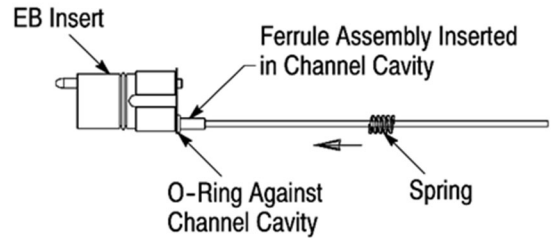

#### Detail B

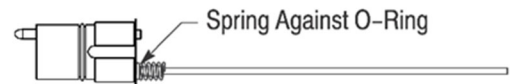

#### Using the Ferrule Insertion Tool

- 1 Place Jaw of Tool Over Spring
- 2 Push Against Spring Until Jaw of Tool Bottoms on EB Insert

#### Detail C

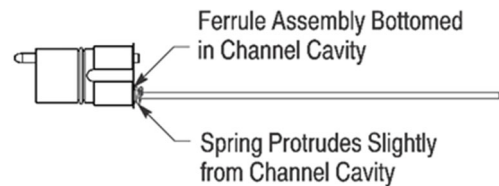

#### Detail D

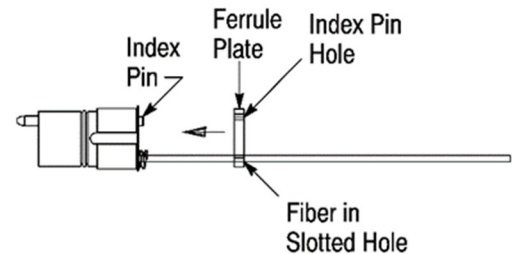

#### Detail E

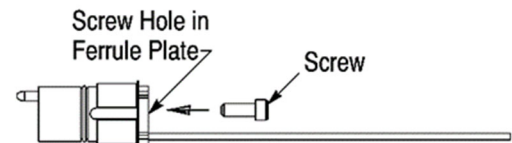

Figure 11

5. Align the index pin hole of the ferrule plate with the index pin at the back of the EB insert, and slip the fiber into the closest slotted hole in the ferrule plate. See Figure 11, Detail C.
6. Hold the ferrule plate against the EB insert, making sure that the index pin enters the index hole. Thread the screw through the screw hole in the ferrule plate and into the hole in the EB insert. See Figure 11, Detail D. Using the 2-mm hex wrench, tighten the screw to a torque between 0.8 and 1 N·m. Check to make sure that the ferrule plate is flush with the EB insert.

7. Align the guide pins with the guide holes, and fit the EB insert installation tool onto the EB insert. See Figure 12, Detail A.

8. Using an applicator swab, apply a *thin film* of the O-ring grease around the O-ring of the EB insert assembly (refer to Figure 12, Detail A), around the inside of the front seal on the inside of the housing, and around the internal O-ring on the inside of the D-hole housing (refer to Figure 12, Detail B). Remove any excess grease.



**CAUTION** To avoid contaminating optical components, DO NOT use heavy deposits of the O-ring grease.

9. Align the D-hole housing with the back (end opposite the front seal) of the housing so that the desired rotational orientation is established (use the flat on the D-hole housing as the reference point). Then slide the D-hole housing onto the housing until it stops (it will “snap” into place). The interference fit of the internal O-ring of the D-hole housing with the housing should prevent the D-hole housing and housing from separating during assembly. See Figure 12, Detail C.



**NOTE** There are 4 rotational orientations for mounting the connector to the panel: top, bottom, left, or right. Aligning one of the keyways located inside the D-hole housing with one of the external keys of the housing will establish the rotational orientation (one keyway is parallel to the flat).

10. Align the internal key (small bar inside) of the housing with the keyway (slot along the side) of the EB insert, and slide the EB insert installation tool into the housing. See Figure 12, Detail D.

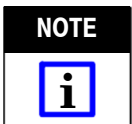

**NOTE** Using the EB insert installation tool will help guide the EB insert into the front seal inside the housing and prevent the O-ring grease from contaminating the face of the EB insert.

11. Using the 2-mm hex wrench, push the EB insert assembly (with the installation tool) into the housing until it bottoms (there will be a tactile “click” as the O-ring of the EB insert assembly seats into place in the housing). To avoid damage to the fiber, DO NOT push on the fiber or cable to install the EB insert assembly. Refer to Figure 12, Detail E.

12. Remove the EB insert installation tool from the housing.

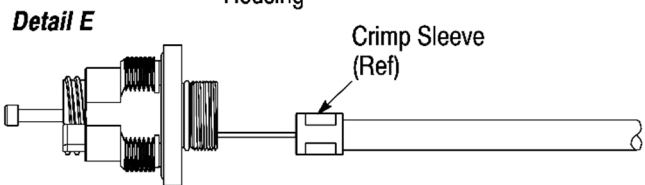
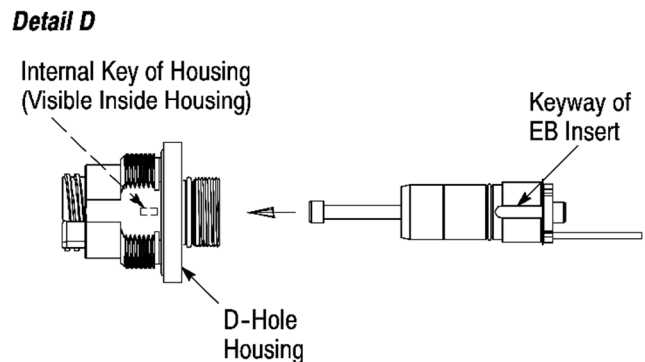
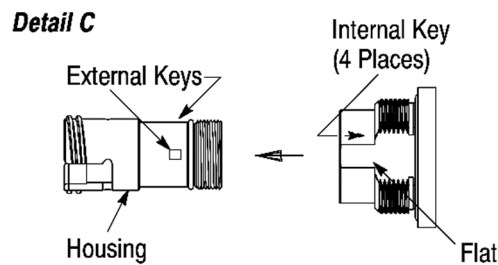
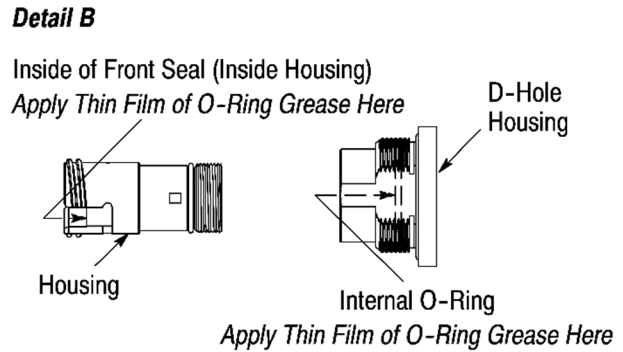
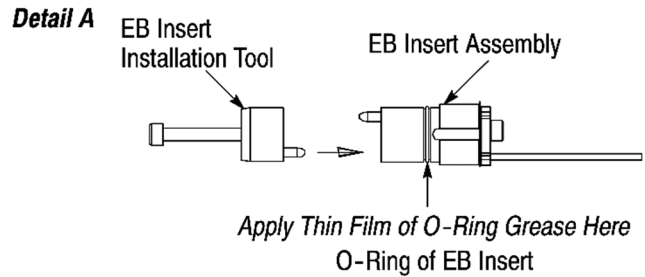
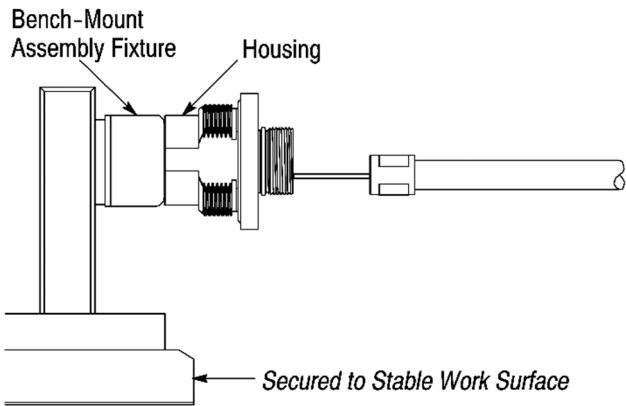

Figure 12



13. Secure the bench-mount assembly fixture to a stable work surface. Fit the housing onto the captive housing of the bench-mount assembly fixture, taking care to not dislodge the EB insert assembly from the housing. See Figure 13, Detail A.

**Detail A**



14. Slide the wave spring over the crimp sleeve and into the housing. See Figure 13, Detail B.

**Detail B**

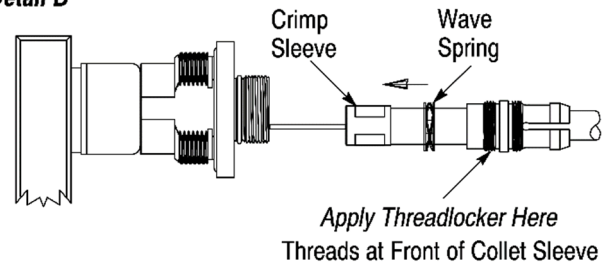

15. Apply 2 to 3 drops of the threadlocker to the threads at the front of the collet sleeve. See Figure 13, Detail B.

16. Slide the collet sleeve over the crimp sleeve and into the housing. Thread the collet sleeve onto the housing, BEING VERY CAREFUL TO NOT pinch the end of the collet sleeve which would cause the cable to twist. Using the 13-mm open-end wrench, tighten the collet sleeve to a torque between 3 and 4 N·m. Refer to Figure 13, Detail C.

**Detail C**

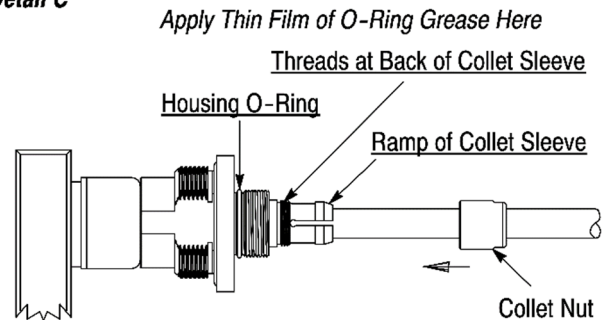

17. Using an applicator swab, apply a *thin film* of the O-ring grease to the housing O-ring, threads at the back of the collet sleeve, and the ramp of the collet sleeve. Refer to Figure 13, Detail C.

18. Slide the collet nut onto the collet sleeve. See Figure 13, Detail C and Detail D. Using the 13-mm open-end wrench, tighten the collet nut to a torque between 1 and 2 N·m.

**Detail D**

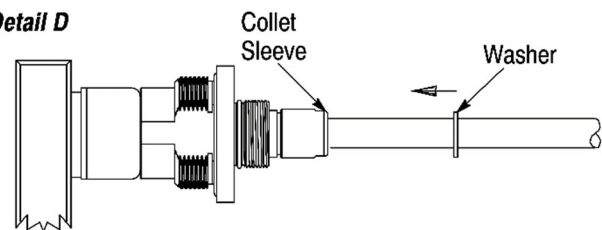

19. Slide the washer against the collet sleeve. See Figure 13, Detail D.

20. Slide the cable seal over the cable until it is approximately 10 mm from the washer. See Figure 13, Detail E.

**Detail E**

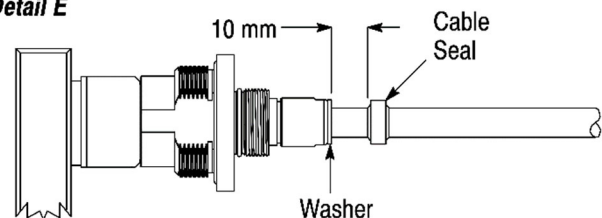
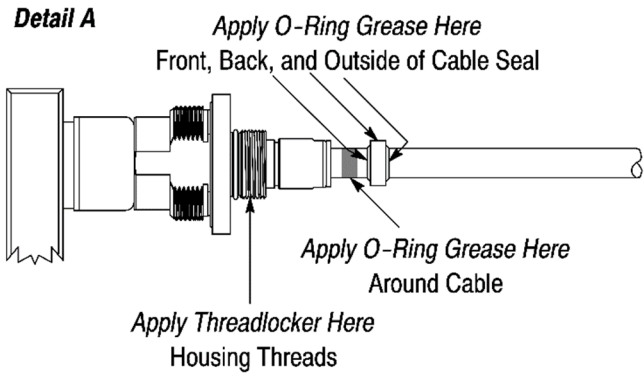

Figure 13

21. Apply the O-ring grease to the front and back and to the outside diameter of the cable seal. Also, apply the O-ring grease around the cable jacket between the cable seal and the washer. See Figure 14, Detail A.



22. Apply several drops of the threadlocker to the threads of the housing. See Figure 14, Detail A.

23. Apply a *thin film* of the O-ring grease to the inside edge of the extension (this is necessary to prevent damage to the O-ring of the housing). See Figure 14, Detail B.

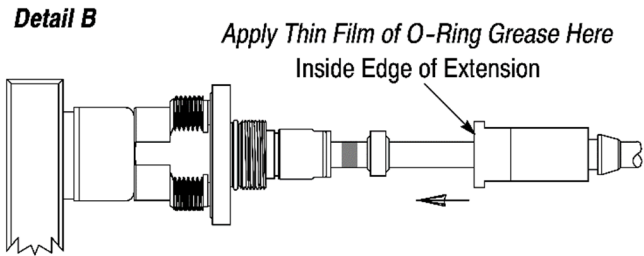

24. Slide the extension over the collet nut, and thread the extension onto the housing. Using the 16-mm open-end wrench, tighten the extension to a torque between 4 and 6 N·m. See Figure 14, Detail B.

25. Apply the instant adhesive completely around the cone of the extension. See Figure 14, Detail C.

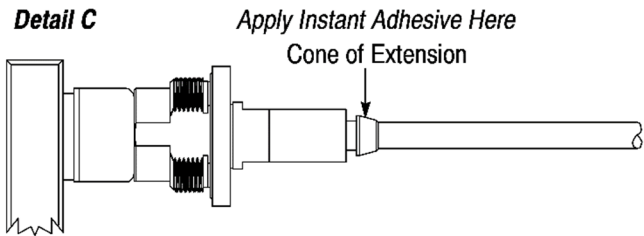

26. Slide the boot over the cone of the extension until it is tight against the shoulder of the extension. See Figure 14, Detail D.

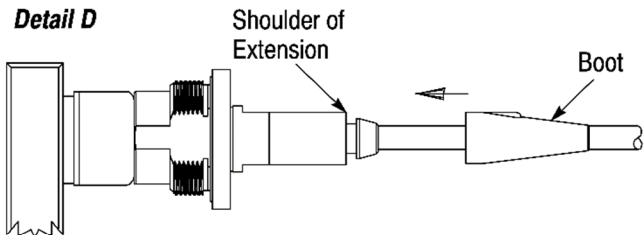

27. Immediately rotate the boot so that the orientation tab is aligned with the top of the bench-mount assembly fixture. See Figure 14, Detail D. Remove any excess adhesive.

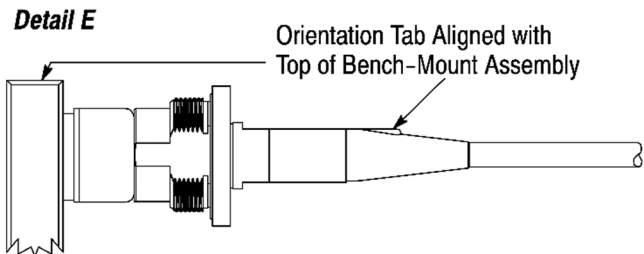

28. Remove the connector assembly from the bench-mount assembly fixture and verify that the orientation tab of the boot is aligned with the guide pin of the EB insert. See Figure 14, Detail F. If not, rotate the boot until it is aligned.

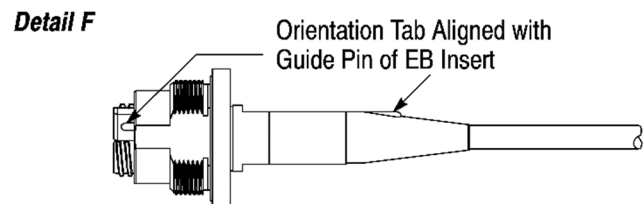

Figure 14

### 5.6. Mount the Connector onto the Panel and Install the Protective Cap

1. Cut the panel using the dimensions provided in Figure 15.



*Make sure that the flat edge is located in position to match the established rotational orientation.*

2. Install the connector through the back of the panel so that the O-ring on the shoulder of the D-hole housing is flat against the front of the panel. See Figure 16, Detail A.

3. Thread the panel nut onto the D-hole housing. See Figure 16, Detail A. Tighten the panel nut to a torque between 20 and 30 N·m. The O-ring should now be compressed.

4. Thread the protective cap onto the housing. Hand-tighten the protective cap. See Figure 16, Detail B.

### 6. REPLACEMENT AND REPAIR

Kit components are not repairable. DO NOT use any damaged or defective components. DO NOT attempt to re-use the crimp support, crimp sleeve, or ferrule assembly by removing the fiber.

Order replacement parts through your TE Connectivity representative, or call 1-800-522-6752, or use the LIVE CHAT on the [www.te.com](http://www.te.com) website.

### 7. REVISION SUMMARY

Revisions to this instruction sheet include:

- Updated document to current corporate requirements
- Section 4.1: updated fiber stripping tool and polishing bushing p/n's, removed epoxy p/n and replaced with recommended epoxy type, removed polishing plate
- Section 5.4: revised singlemode/multimode polish requirements and Steps 3, 6, and 8
- Revised and added to the Detail illustrations in Figure 11 to better correspond to the ferrule assembly installation text of Section 5.6. Steps 1 through 6.

**Recommended Panel Cutout**  
Panel Thickness Range of 1-6 mm

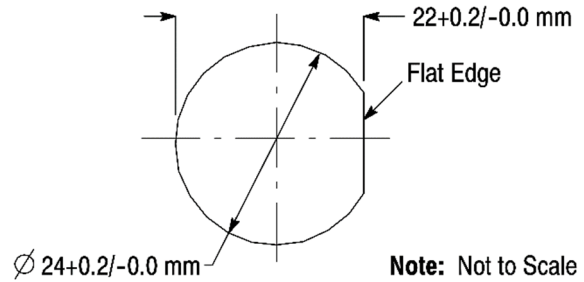
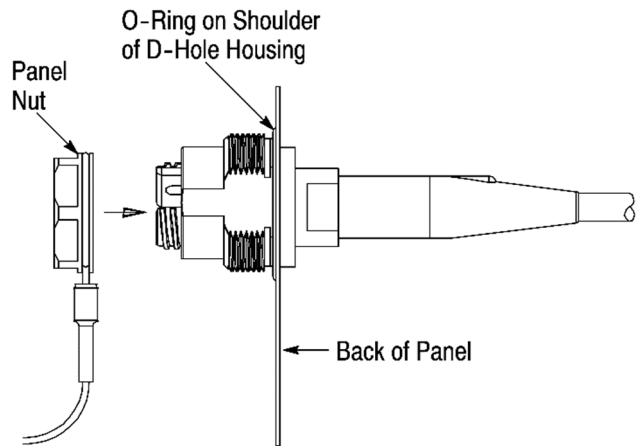

Figure 15

**Detail A**



**Detail B**

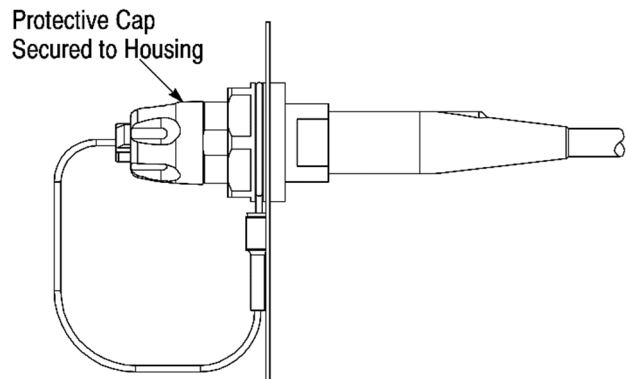

Figure 16