

---

## 2-8pos. MCON 1.2 – LL Connector, Sealed with SWS

---

### TABLE OF CONTENTS

#### 1 GENERAL

- 1.1 PURPOSE
- 1.2 CUSTOMER DRAWINGS
- 1.3 DELIVERY CONDITION
  - 1.3.1 CONNECTORS WITHOUT CPA
  - 1.3.2 CONNECTORS WITH CPA
  - 1.3.3 TERMINALS
  - 1.3.4 CONNECTORS ARE BULK PACKAGED
  - 1.3.5 DUE TO BULK PACKAGING, IT IS POSSIBLE FOR THE RETAINER TO SHIFT DURING TRANSPORTATION
  - 1.3.6 SHOULD THIS OCCUR, SHIFT RETAINER TO PRE-LOCK POSITION AS DIMENSIONED ON TE CUSTOMER DRAWING PRIOR TO TERMINAL LOADING (Ref dim 2mm)

#### 2 CONNECTOR 2 TO 8POS, MCON 1.2 WITH SWS

- 2.1 ASSEMBLY OF THE CONNECTORS (VALID FOR ALL PIN COUNT VERSIONS)
- 2.2 TERMINAL INSERTION INSTRUCTIONS
- 2.3 APPLICABLE WIRES
- 2.4 RETAINER ENGAGE INSTRUCTIONS
- 2.5 RETAINER DISENGAGE INSTRUCTIONS
- 2.6 TERMINAL REMOVAL INSTRUCTIONS

#### 3 MATING AND UNMATING OF THE CONNECTORS

- 3.1 MATING WITH CPA
- 3.2 UNMATING WITH CPA
- 3.3 MATING WITHOUT CPA
- 3.4 UNMATING WITHOUT CPA

#### 4. DOCUMENT CHANGE HISTORY

## 1 GENERAL

### 1.1 PURPOSE

THIS SPECIFICATION DESCRIBES HOW TO HANDLE THE COMPONENTS OF THE CONNECTORS 2- TO 8 POS., MCON 1.2 WITH SWS (Single Wire Seal)

### 1.2 CUSTOMER DRAWINGS

THIS APPLICATION SPECIFICATION IS BASED ON THE LATEST VALID CUSTOMER DRAWINGS.

INTERFACE SPECIFICATION:  
SEE TYCO ELECTRONICS FRAME SPECIFICATION: **114-18679-3**

1.3 DELIVERY CONDITION

1.3.1 CONNECTORS WITHOUT CPA

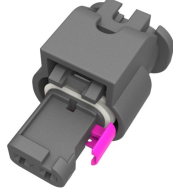
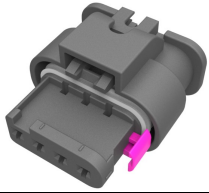
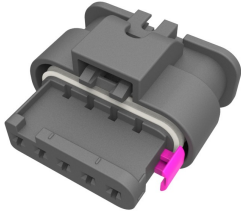
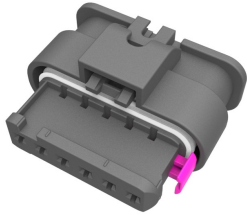
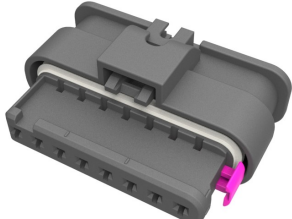
<p>2pos. MCON 1.2 – LL Connector</p>	
<p>3pos. MCON 1.2 – LL Connector</p>	
<p>4pos. MCON 1.2 – LL Connector</p>	
<p>5pos. MCON 1.2 – LL Connector</p>	
<p>6pos. MCON 1.2 – LL Connector</p>	
<p>8pos. MCON 1.2 – LL Connector</p>	

1.3.2 CONNECTORS WITH CPA

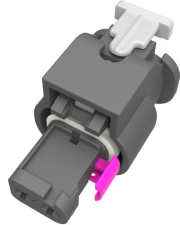
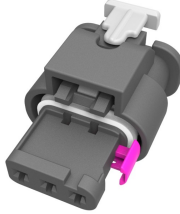
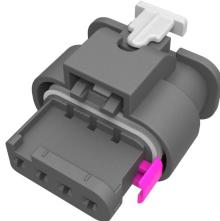
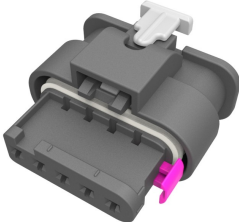
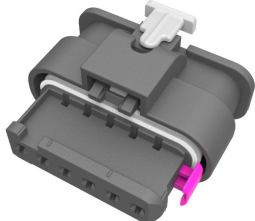
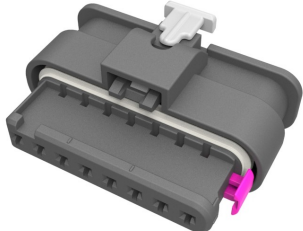
<p>2pos. MCON 1.2 – LL Connector</p>	
<p>3pos. MCON 1.2 – LL Connector</p>	
<p>4pos. MCON 1.2 – LL Connector</p>	
<p>5pos. MCON 1.2 – LL Connector</p>	
<p>6pos. MCON 1.2 – LL Connector</p>	
<p>8pos. MCON 1.2 – LL Connector</p>	

1.3.3 TERMINALS

<p>MCON 1.2 – LL Terminals</p>	<p>CUSTOMER DRAWING <b>1452674</b></p> <p>APPLICATION SPEC. <b>114-18464</b></p> <p>PRODUCT SPEC. <b>108-18782</b></p>	
--------------------------------	--	---

## 2 CONNECTOR 2 TO 8POS, MCON 1.2. WITH SWS

### 2.1 ASSEMBLY OF THE CONNECTORS (VALID FOR ALL PIN COUNT VERSIONS)

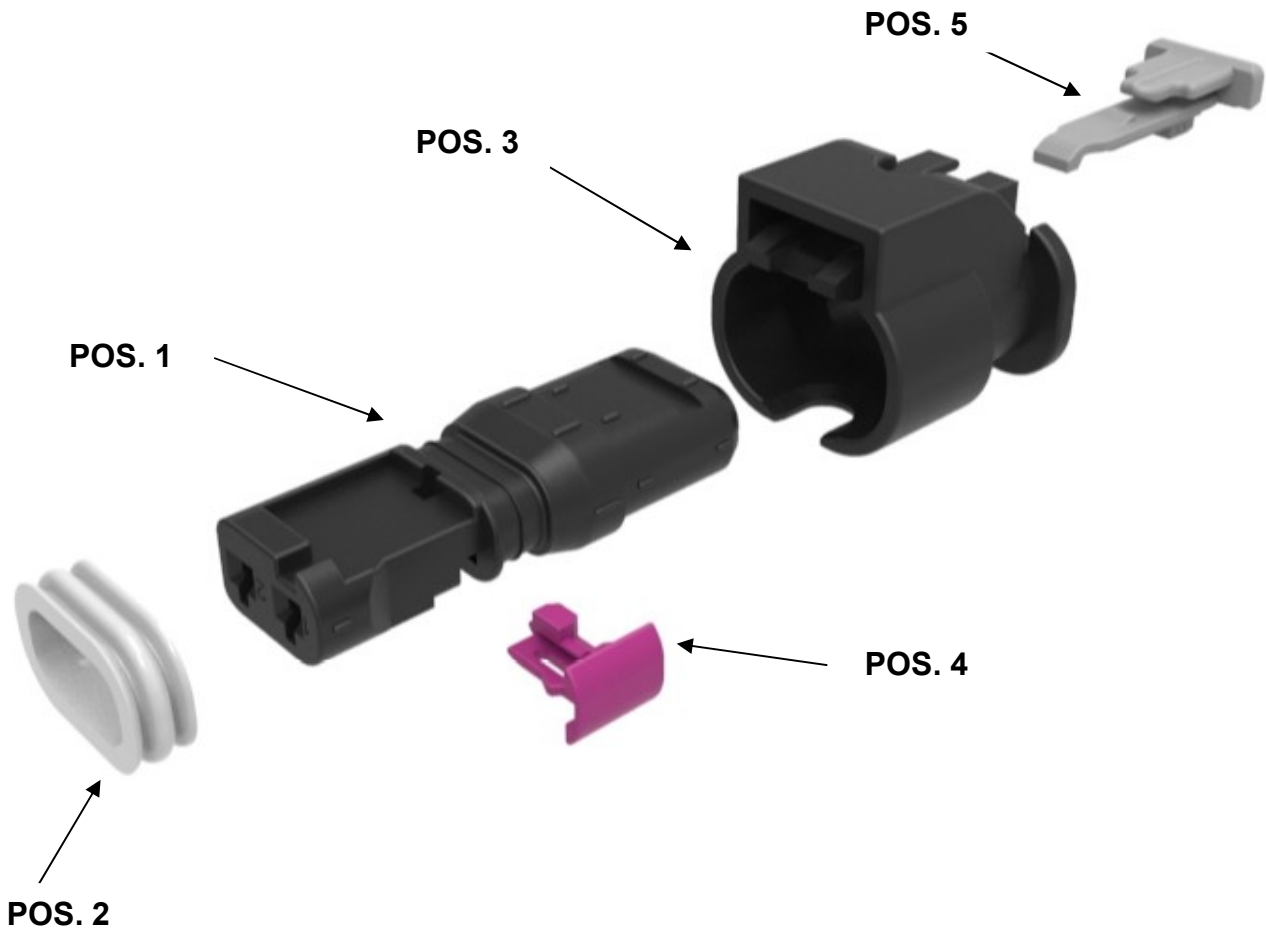

POS. 1: Receptacle Housing

POS. 2: Peripheral Seal

POS. 3: Protection Cover

POS. 4: Retainer

POS. 5: CPA

2.2 TERMINAL INSERTION INSTRUCTIONS

INSERTION DIRECTION

ORIENTATION FEATURE OF THE TERMINAL.



INSERT TERMINAL UNTIL AN AUDIBLE CLICK IS HEARD OR THE LOCK IS FELT

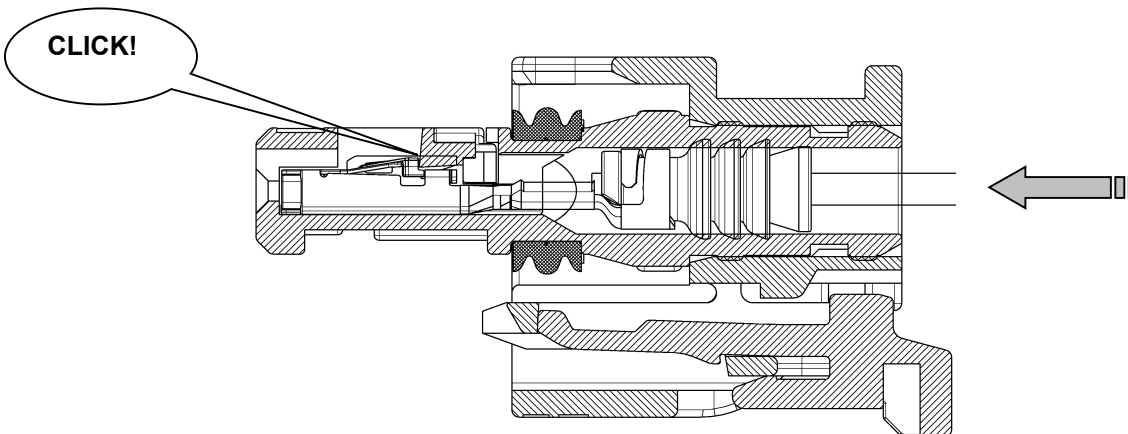

IN CASE OF 1mm<sup>2</sup> CABLE WITH 180° CABLE EXIT, SWS PROTRUSION DURING TERMINAL INSERTION OF **MAX. 0.5mm** IS ALLOWED. THIS IS ALLOWED FOR THE SEAL COLLAR ONLY. THE SEALING LIPS MUST REMAIN IN THE CONTACT CAVITY AT ALL TIMES.

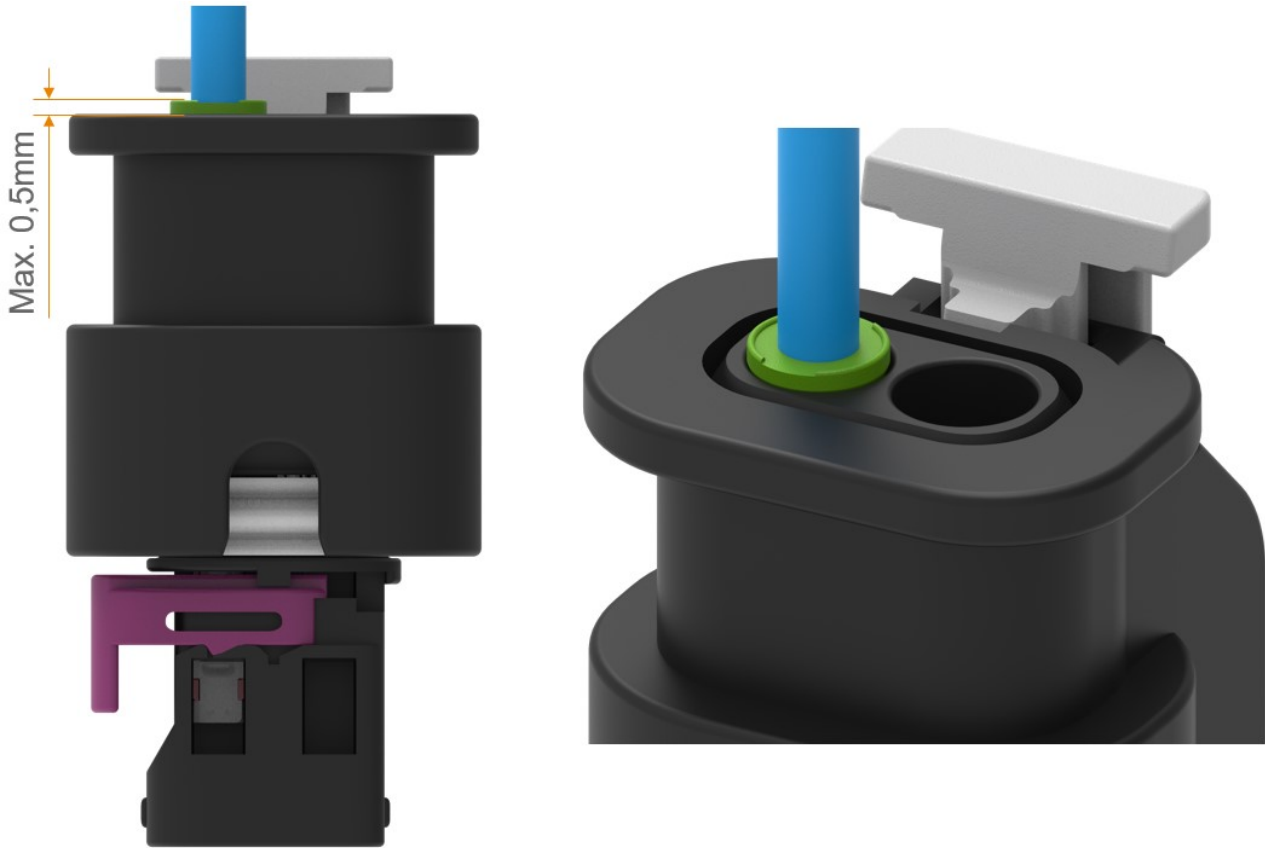

2.3 APPLICABLE WIRES

SEE ALSO THE CUSTOMER DRAWINGS **1452674**

Accessories							
Wire			Part numbers				
Type (DIN 76772)	Ø	mm <sup>2</sup>	MCON 1.2 LL	Single wire seal		Blind plug PN / Color	
FLR & ACW	1.2-1.4	0.35	7-1452665-3	Yellow	967067-2	967056-1	Blue
	1.4-1.6	0.50	7-1452668-3	Green	967067-1		
	1.7-1.9	0.75	7-1452668-3	Green	967067-1		
	1.9-2.1	1.00	7-1452671-3	Green	967067-1		
	2.2-2.4	1,50	7-1452671-3	Green	2287497-1		



2.4 RETAINER ENGAGE INSTRUCTIONS

INSERTION OF THE RETAINER TO END-LOCKED POSITION

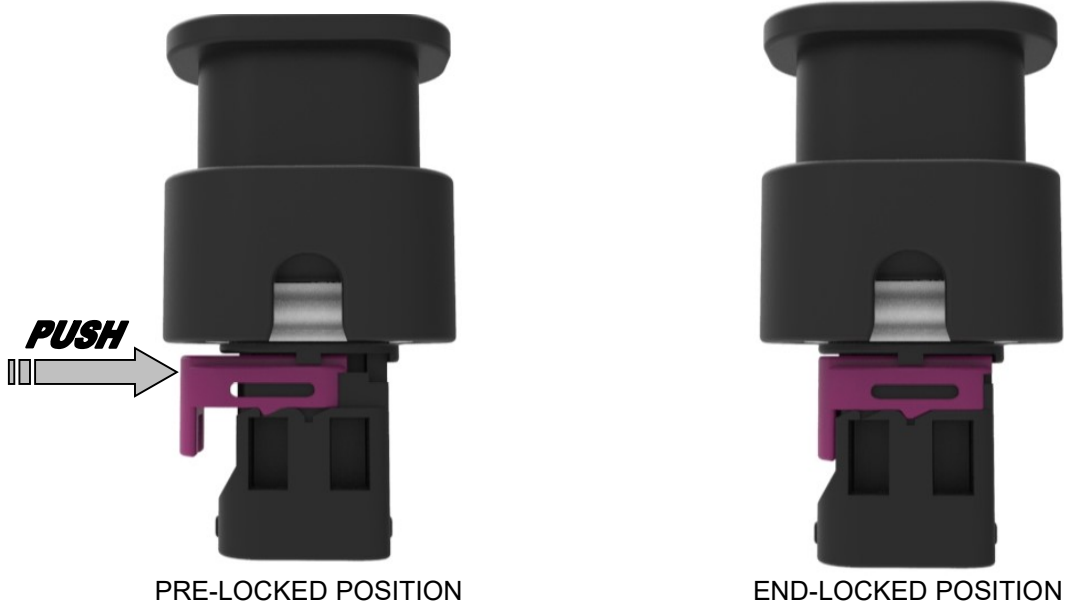

## 2.5 RETAINER DISENGAGE INSTRUCTIONS

PLACE THE EXTRACTION TOOL (E.G. SCREWDRIVER) IN THE SHOWN PLACE TO DISENGAGE THE RETAINER.



RETAINER ONLY TO MOVE TO THE PRE-LOCKED POSITION

## 2.6 TERMINAL REMOVAL INSTRUCTIONS

INSERT THE EXTRACTION TOOL (TYCO-PN: 5-1579007-3) TO LOCKING HOOK. THE TERMINALS CAN BE REMOVED BY PULLING THE CABLE AND SIMULTAENEOUSLY BENDING THE LOCKING HOOK

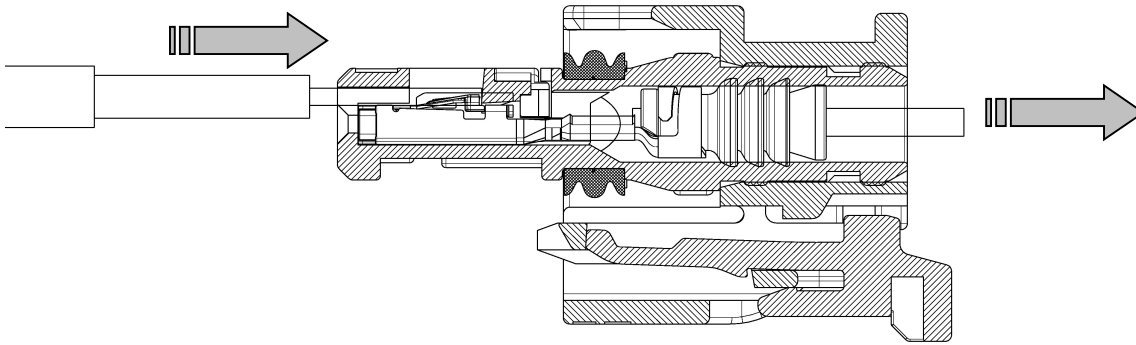

### 3. MATING AND UNMATING OF THE CONNECTORS

#### 3.1 MATING WITH CPA

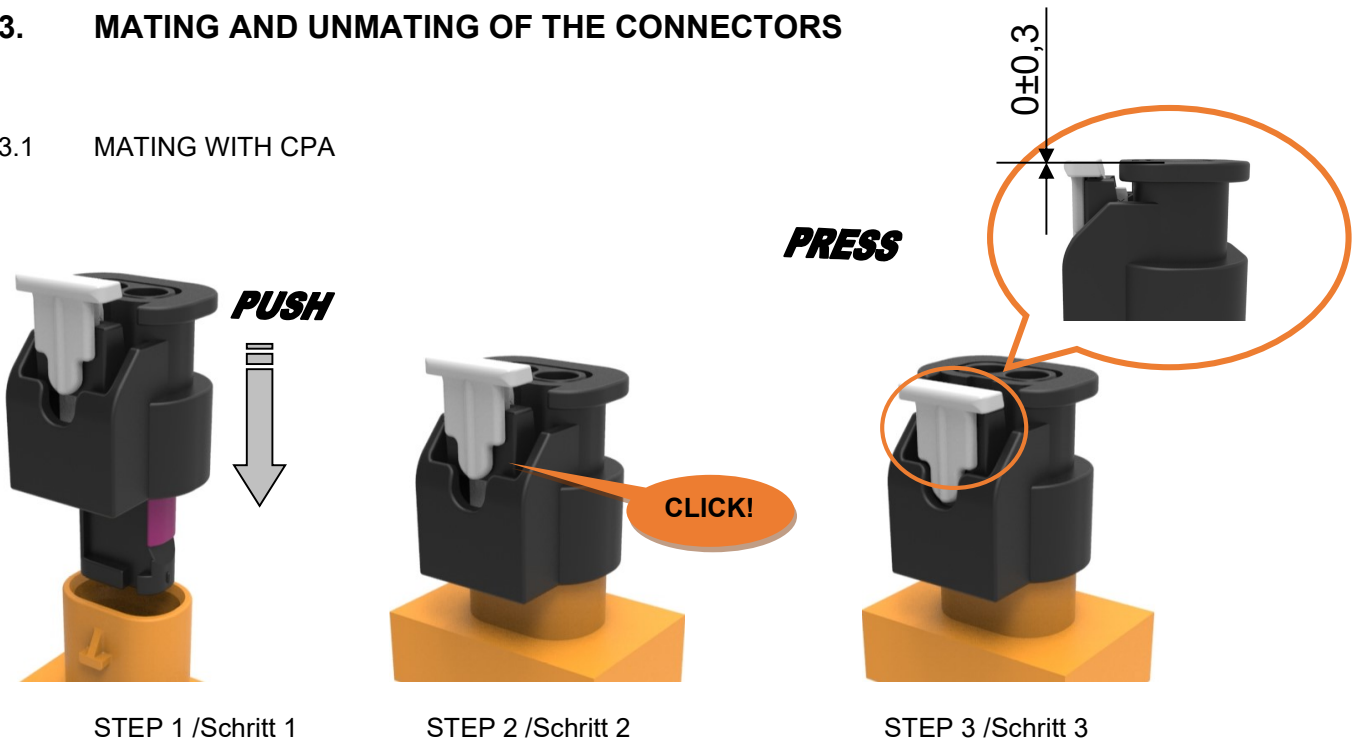

#### 3.2 UNMATING WITH CPA

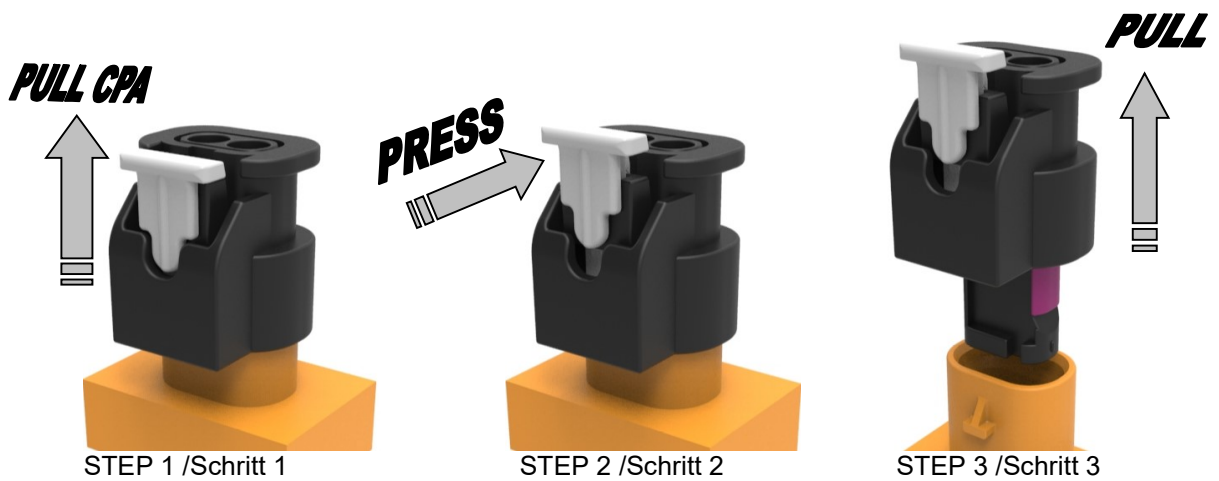

3.3 MATING WITHOUT CPA

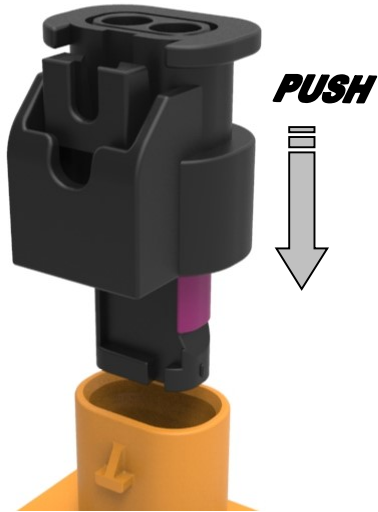

STEP 1

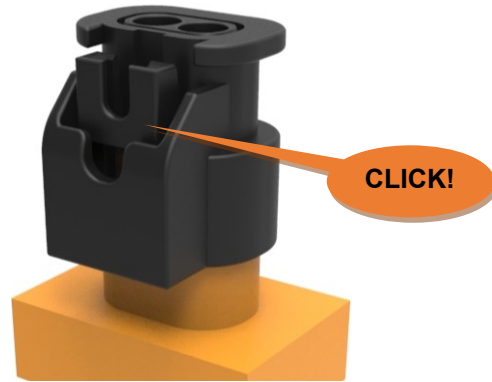

STEP 2

3.4 UNMATING WITHOUT CPA

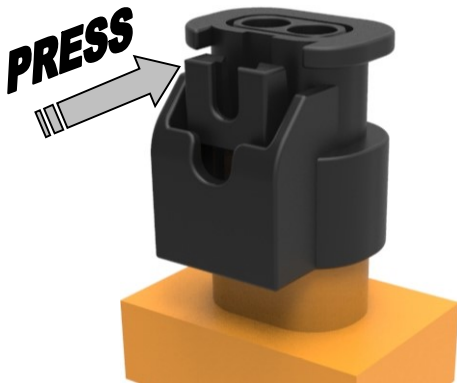

STEP 1

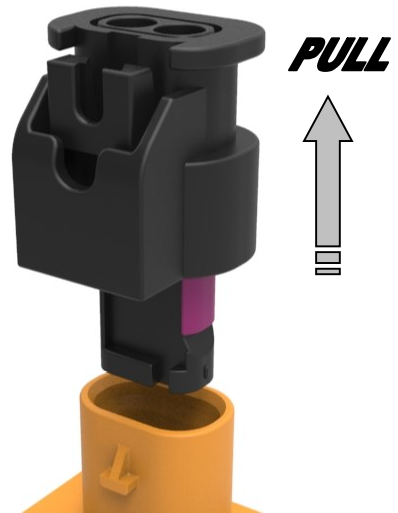

STEP 2

---

**DOCUMENT CHANGE HISTORY**

	<b>NAME</b>	<b>DATE</b>	<b>REV</b>	<b>CHANGE</b>
<b>CHANGE HISTORY</b>	-	18SEP2007	A	Initial document
	Sz. Nemes	11AUG2013	A1	Point 1.3.3 - 1.3.6 added
	Sz. Nemes	26SEP2019	A2	Cosmetical update Wire insulation info added for 1,5mm <sup>2</sup> cable
	Sz. Nemes	13DEC2023	A3	Information on SWS protrusion added