



NOTE

1. All numerical values are in metric units [with U.S. customary units in brackets]. Dimensions are in millimeters [and inches]. Unless otherwise specified, dimensions have a tolerance of ± 0.13 [$\pm .005$] and angles have a tolerance of $\pm 2^\circ$. Figures and illustrations are for identification only and are not drawn to scale.
2. Connectors can only be used with approved combination of TE machines and TE approved wires. Contact sales representative for approved combination list or to initiate an approval for a new combination IDC TE Connector – TE Termination machine – wire.
3. According to RAST guidelines and for a proper machine functioning at least one keying rib has to be kept on the finished configuration.

1. INTRODUCTION

This specification covers the requirements for application of the AMP Multifitting MARK II Direct Connector RAST 5 mm, according to AMP technology where a quality level according to product-specification 108-18653 is guaranteed. The instructions are valid for the use of TE processing machines of every possible design.

The AMP Multifitting MARK II Direct Connector, RAST 5mm, is to be used as Card Edge Connector for printed circuit boards. The contact of the PCB is being guaranteed by contact pressure of the spring pair against conductor pads of the PCB (one or both sides laminated) which are especially provided for this. The exact positioning of the receptacle connector is being guaranteed by a mating frame, which is being locked onto the PCB.

Basic terms and features of this product are provided in Figure 1.

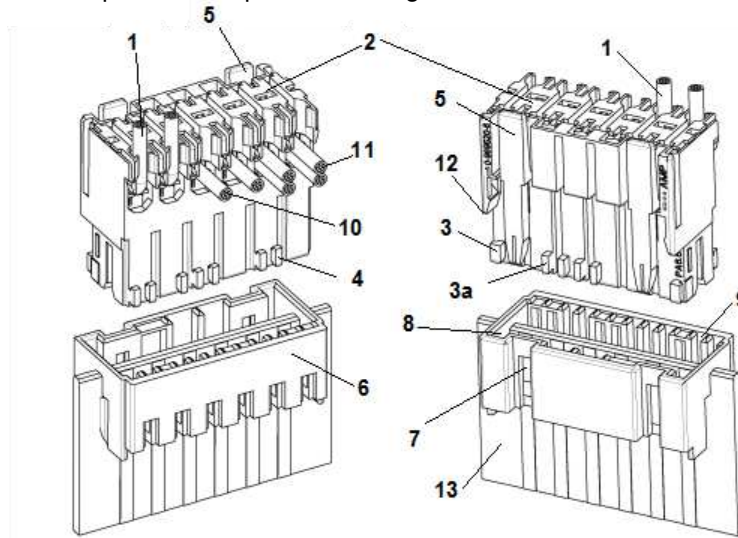

1	Wire Exit 90° locked in cover-recess
2	Cover for wire support locked separately in each cavity
3	Keying (first and last cavity)
3a	Typical keying rib
4	Polarization similar to the keying of the front side
5	Exterior locking latch
6	PC-Board Frame
7	Latching hole
8	Keying in PC-Board Frame
9	Polarization in PC-Board Frame

10	Wire exit 180°
11	Double wire in ID slot
12	Mating stop
13	PC Board

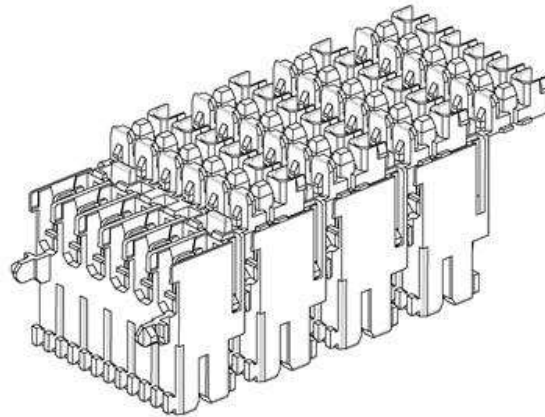

Figure 2: 1 and multiple position connectors in connector chains

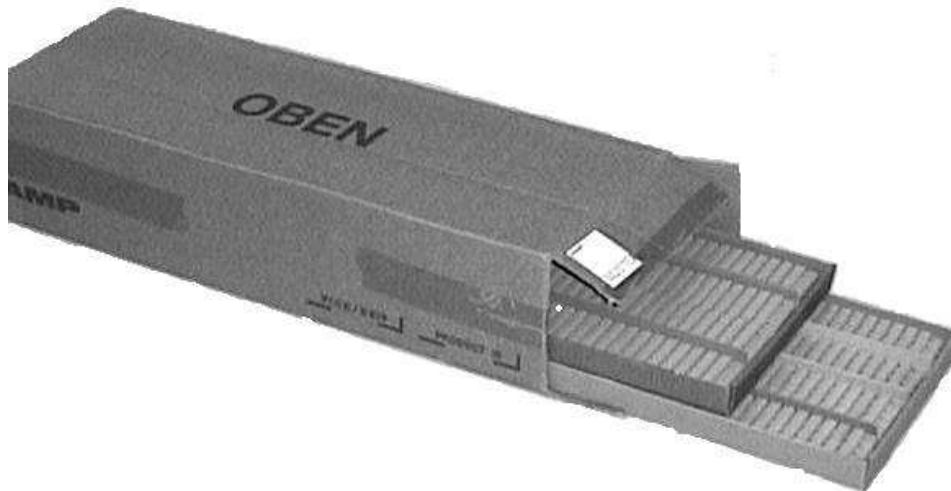

Figure 3: Condition of material as to be delivered, see spec. 107-18008

2. REFERENCE MATERIAL

2.1. Revision Summary

Revisions to this specification include:

- Updated document format to corporate requirements.

2.2. Customer Assistance

Reference Product Base Part Numbers 1241172, 1534075 and Product Code 2131 are representative of AMP Multifitting MARK II Direct Connector RAST 5 mm. Use of these numbers will identify the product line and help you to obtain product and tooling information when visiting www.te.com or calling the number at the bottom of page 1.

2.3. Drawings

Customer drawings for product part numbers are available from www.te.com. Information contained in the customer drawing takes priority.

2.4. Specifications

Product Specification [108-18652](#) provides product performance and test results. Packaging Specification [107-18008](#) provides packaging details.

2.5. Instructional Material

Instruction sheets (408-series) provide product assembly instructions or tooling setup and operation procedures and customer manuals (409-series) provide machine setup and operating procedures. Instructional material that pertain to this product are:

[107-18008](#) Packaging Specification – AMP Multifitting Connector R 5mm and ID Poke-In Connector R 5.6mm

3. REQUIREMENTS

3.1. Safety

Do not stack product shipping containers so high that the containers buckle or deform.

3.2. Storage

A. Ultraviolet Light

Prolonged exposure to ultraviolet light may deteriorate the chemical composition used in the product material.

B. Shelf Life

The product should remain in the shipping containers until ready for use to prevent deformation to components. The product should be used on a first in, first out basis to avoid storage contamination that could adversely affect performance.

C. Chemical Exposure

Do not store product near any chemical listed below as they may cause stress corrosion cracking in the material.

Alkalies	Ammonia	Citrates	Phosphates	Citrates	Sulfur Compounds
Amines	Carbonates	Nitrites	Sulfur Nitrites		Tartrates

3.3. Visual Control of the Connector before Application

Concerning all following details, a visual, or possibly dimensional check will be sufficient.

A. Relation of Wire and Contact

Only conductors according to point 4.3 are qualified for termination process. Differing wires need to have a special release.

B. Contact

The contact should not be visibly deformed. Slight scratches, which do not go through to the basic material, are allowed.

C. Center Position of the Termination Slot

The center position of the termination slot has to conform to the given symmetric tolerances. See Figure 4.

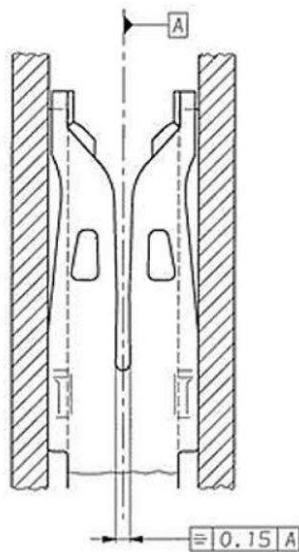

Figure 4

D. Housing

Prior to processing the housings are not allowed to show damages occurred by incorrect machine setting, broken tools etc.

E. Cut-off Points of the Stick Mould Tie Up

The cut-off point has to be within the field of tolerance shown in Figure 5. A slight break-out of the housing during the cutting process is allowed.

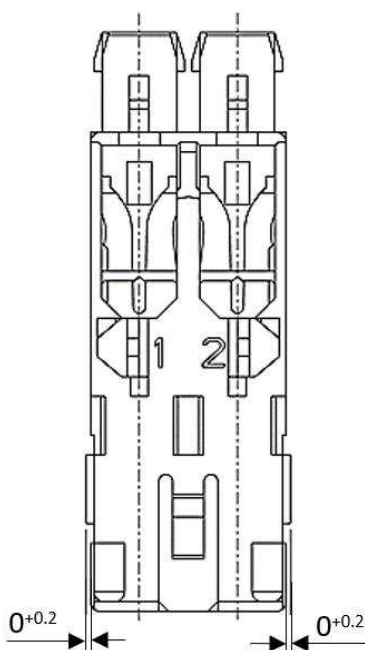

Figure 5

F. Wire

The wire should not show any damages.

3.4. Visual Check of the Terminated Connectors

Concerning all following details, a visual, or possibly dimensional check will be sufficient.

A. Contact

Contacts should have no damages. Particular concern should be taken regarding the damage of contacts by the wire insertion tool. Slight scratches, which do not go through to the basic material are allowed.

B. Examination of the Wire Insertion Depth

An essential characteristic for the correct function of the insulation displacement technique is the wire insertion depth. With AMP Multifitting MARK II Indirect Connector an examination of the wire position is required. Wire insertion depth is correct, when the insulation of the wire is placed onto the connectors wire support. See Figure 6, Figure 7 and Paragraph 4.4.

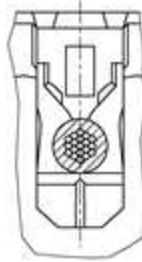

Figure 6



Figure 7

C. Position of the Contact within the Housing

After completion of all operation the contact has to fit into the housing still correctly. See Figure 8 and Paragraph 4.6.

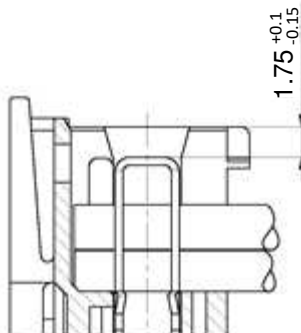

Figure 8

D. Wire Position Inside the Housing

The positioned wire may touch the wall resp. a max. of 1.0 mm clearance is allowed. A deformation of the wire occurred by excessive length is not allowed. See Figure 9 and Paragraph 4.5.

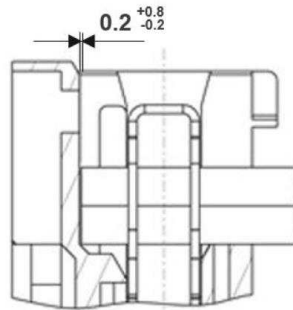

Figure 9

E. Housing

The housings should not show any damages after being processed, due to faulty machine setting, broken tools etc.

F. Cutting Area of the Keying Ribs

The housings have to be burr-free after cutting off of the keying ribs resp. be within tolerances shown in Figure 10. A slight break-out of housings during cutting does not affect the function and is allowed.

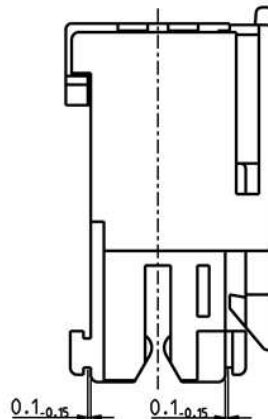

Figure 10

G. Disconnection Points of the Linked Cover

These dislinkage points between housing and cover have to be within tolerance according Figure 11. Remaining burrs may have an excess of max. 0.5 mm either on cover front or housing rear side. A slight break-out of the housings while cutting is allowed.

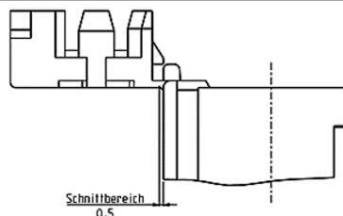

Figure 11

H. Cutting Area of the Connective Straps

The housings have to be burr-free after disconnection of the connective straps, resp. be within the tolerances shown in Figure 12. A slight break-out of the housings while cutting is allowed.

I. Cover Locking

After insertion of the conductor, contact and wire are being protected by the cover. Precise function of the cover is ensured, when the front and the rear locking latch have locked into the given notches.

J. Stacking of Connectors in Customer Applications

Only a total of 12 pitches is allowed to be placed side by side, regardless what connector combination will be plugged. A spacer of min. 0.75 to 1mm is required for the next total of 12 pitches.

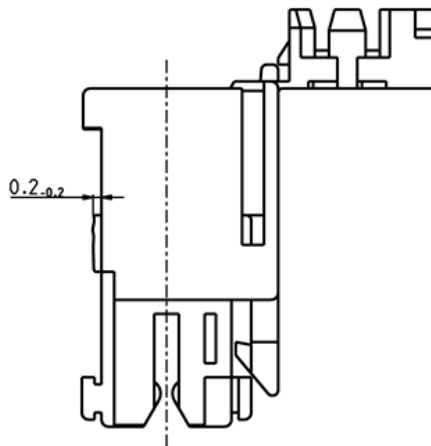

Figure 12

4. QUALITY PRECAUTIONS

The actions listed below serve as quality assurance of the AMP Multifitting Indirect Connector System as to the prod.-spec. 108-18653 and have to be done when changing the following parameters:

- Introduction of a new product
- Change of wire
- Change of tooling

4.1. Slot Width of the Contact

The slot-width, which determines for an efficient termination of the conductor, is kept and guaranteed by TE Connectivity.

4.2. Center Position of the Termination Slot

See Paragraph 3.3.C. A visual check is sufficient and, if being unsure, a dimensional examination may be carried out.

4.3. Quality of the Conductor

The spec. of the conductor (see pages 8 - 12 of 12) given by TE Connectivity has to be followed, exceptions need to have a special release by TE Connectivity.

A. Conductor

The AMP Multifitting MARK II Indirect Connectors are suitable for the following wire ranges:

0.35mm ²	stranded wire (7 and 12 strands are preferred)
0.5mm ² -0.75mm ²	stranded wire (7 or multiple strands)
1.0mm ² -1.5mm ²	stranded wire (multiple strands)

Each single strand of the stranded wires should not have less than 0.2 mm diameter.

1. Conductor Variations at Dual Wire Insertion (mm²)

A: 2 x 0.35	B: 0.35 + 0.5*	C: 2 x 0.5	D: 0.5 + 0.75*
E: 2 x 0.75	F: 0.75 + 1.0*	G: 0.5 + 1.0*	

Var. C and D are preferred

*by using miscellaneous conductors the smaller has to be terminated first

B. Isolation

The AMP Multifitting MARK II Indirect Connectors are suitable for an insulation-diameter of 1.4 – 2.8 mm. The lead insulation to be applied should have a shore hardness A92 ±3 according DIN 53505.

4.4. Wire Insertion Depth

The wire insertion depth is determined by the distance of the single strand from the stop latch (see Figure 13) or the stop edge with dual wire insertions (see Figure 14) and by the wire positioning according to Paragraph 5.2.

Wire Range (a)	Bending of Stop Latch X [mm]	Deformation Y [mm]	Distance A
0.35 (b)	0 (b)	—	—
0.5	0 – 0.75	—	—
0.75	0 – 1.0 (c)	—	—
1.0	0.25 – 1.25 (c)	—	—
0.5 + 0.5	≥ 2.4 (c)	0 – 0.2 (d)	0 – 0.3
0.5 + 0.75	≥ 2.4 (c)	0 – 0.35 (d)	0 – 0.2



NOTE

- (a) The adjustment for all workstations is to carry out with 0.35mm² stranded wire.
- (b) A stranded wire (7 or 12 strands) have to be laid out on stop latch "L". At this defined insertion depth other terminated stranded wire 0.5/0.75/... and AWG wires achieve automatically the optimized depth.
- (c) Stop latch may break concentric or onesided.
- (d) Deformation is allowed.

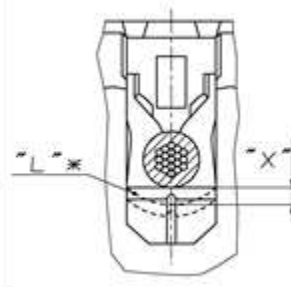
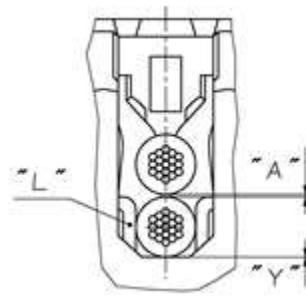
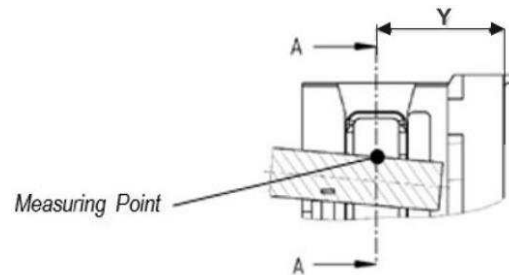

Figure 13

Figure 14

The wire insertion depth is alternatively determined according to dimension Z as shown in Figure 15 and Figure 16. In case of conflict the first method shall prevail.

Figure 15

$Z = 19.15 \pm 0.15$ mm
 Applicable for single wires
 only, all wire sizes
 excluding 0.35mm^2
 $Z = 18.95 \pm 0.15$ mm
 Applicable for 0.35mm^2

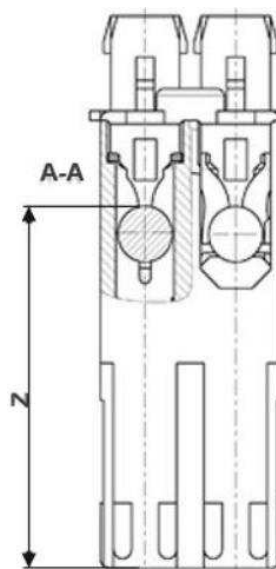
Figure 16

4.5. Position of Wire Inside Housing

See Paragraph 3.4.D. A deformation of excessive wire at the cavity end is not allowed.

A. Position of the Wire Insulation at 180° Wire Exit

The insulation "I" may be cut, thus making the stranded wire as a compound structure visible. This cutting of the insulation effects neither the mechanical nor the electrical characteristics of the connection, and does not vary the compliance of all the applicable norms. Stop latch "L" see Paragraph 4.4. See Figure 17.

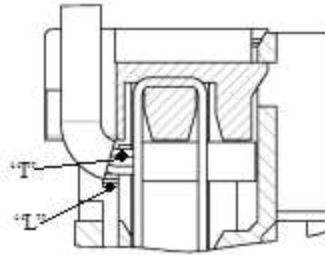

Figure 17

4.6. Position of the Contact Inside Cavity

The center position of the contact to the housing should not exceed a tolerance field of 0.4 mm. The edges of the spring contact may be visible within the entry opening. See Figure 18.

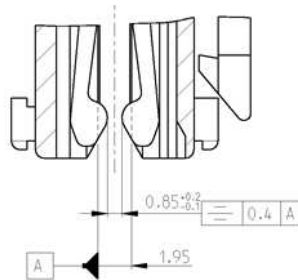

Figure 18

4.7. Coding Rib Cutting Area

The separating points have to be according Paragraph 3.4.F.

4.8. Stickmould Cutting Area

The stickmould cutting points have to be according Paragraph 3.3.E.

4.9. Cover Cutting Area

The cover cutting points have to be according to Paragraph 3.4.G.

4.10. Carrier Strap Cutting Area

The carrier strap cutting points have to be according Paragraph 3.4.H.

4.11. Cover Locking

The cover locking has to be according to Paragraph 3.4.I.

5. QUALITY PROOF

5.1. Tensile Strength of Applied Leads

The terminated conductors are supposed to withstand a tensile strength in axial and vertical direction which corresponds to the figures in the following chart.

Conductor Performance	Axial Direction (See Figure 19)	Vertical Direction (See Figure 20)
Stranded wire, 7 and 12 strands 0.35 mm ² Iso – ø 1.4 mm	50 N (minimum)	30 N (minimum)
Stranded wire, 7 and multiple strands 0.5 mm ² Iso – ø 2.3 mm	50 N (minimum)	30 N (minimum)
Stranded wire, 7 and multiple strands 0.75 mm ² Iso – ø 2.4 mm	50 N (minimum)	40 N (minimum)
Stranded wire, multiple strands 1.0 mm ² Iso – ø 2.8 mm	50 N (minimum)	40 N (minimum)

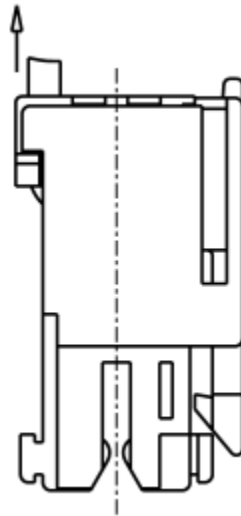

Figure 19

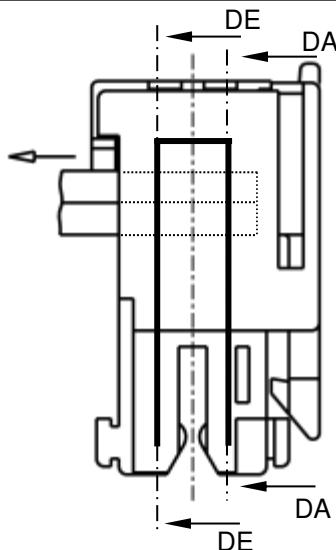
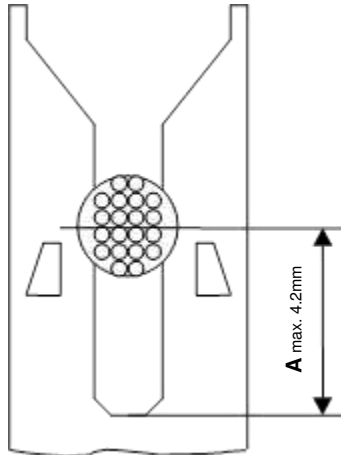

Figure 20

5.2. Cross Sections

The parts to be tested should be inserted bubble-free into clear epoxy resin. The grinding direction should be diagonal to the termination slot and performed to half of the material thickness of the contact. See Figure 21 and Figure 22.

Suggested sequence of grinding: DA (wire exit) and after it DE (wire input). See Figure 19.



A - Maximum distance from the bottom edge to the center of the strand compound from contact 969185-x or 969187-x

Figure 22: Polished section for PN 1241170, 1241172, 1394355, 1534072, 1534075, 1534077

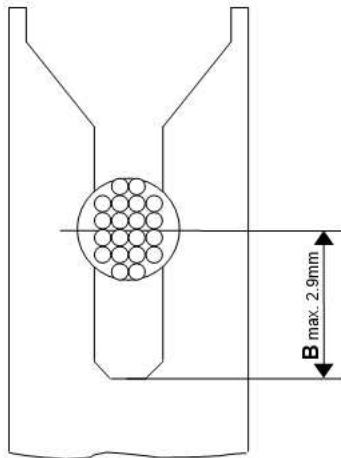

B - Maximum distance from the bottom edge to the center of the strand compound from contact 969186-x

Figure 21: Polished section for PN 1241171, 1394556, 1534073, 1534078

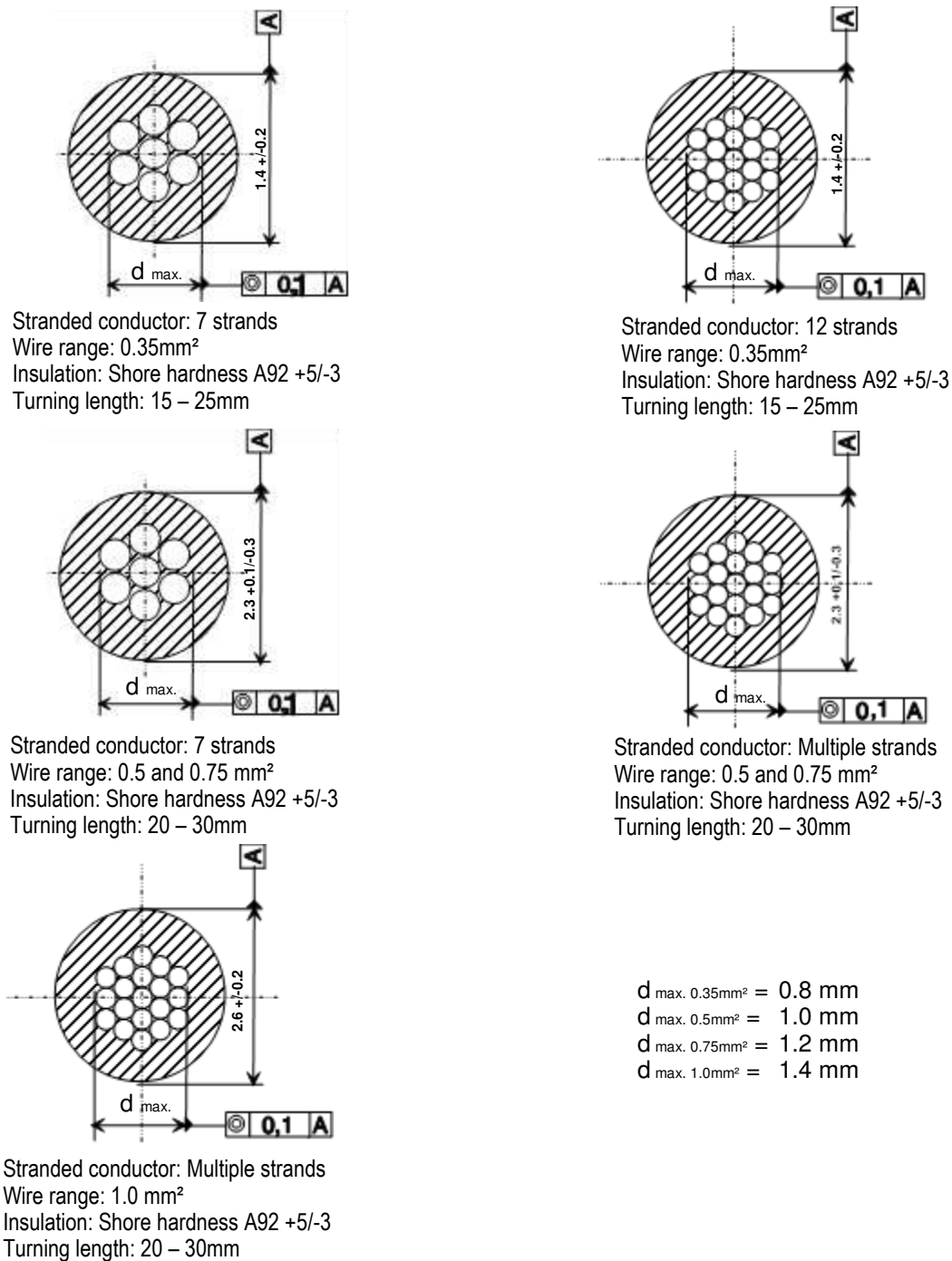
Figure 23: Conductor Cross Sections

NOTE

Stranded wires at AWG only at agreement with product engineering.

5.3. Printed Circuit Board

According to IEC 249, DIN 40801.

6. PRODUCT PROCESSING AFTER TRANSPORT AND STORAGE

To ensure the connector processing after transport and storage at winterly conditions it is necessary to warm up the needed quantity of connectors at a temperature exceeding 10°C for minimum time period of 12h. Attention should be paid to the rule to open the packaging during the warm up time.

The packaging units and pieces should be handled carefully during handling and processing.