

NOTE



All numerical values are in metric units. Dimensions are in millimeters. Unless otherwise specified, dimensions have a tolerance of ± 0.13 and angles have a tolerance of $\pm 2^\circ$. Figures and illustrations are for identification only and are not drawn to scale.

1. INTRODUCTION

This specification covers the application requirement of TE Connectivity (TE) Crown Clip™ Senior Power Connector series (CCS Power). All the connectors are designed to engage specified bus bar board system. TE Connectivity Crown Clip™ Senior Power Connector series is recommended to use in server, storage, data center, switch, etc., based on Open Rack V2.0 Standard, or other industrial equipment.

When corresponding with TE Connectivity Personnel, use the terminology provided in this specification to facilitate your inquiries for information. Basic terms and features of this product are provided as reference Figure 1.

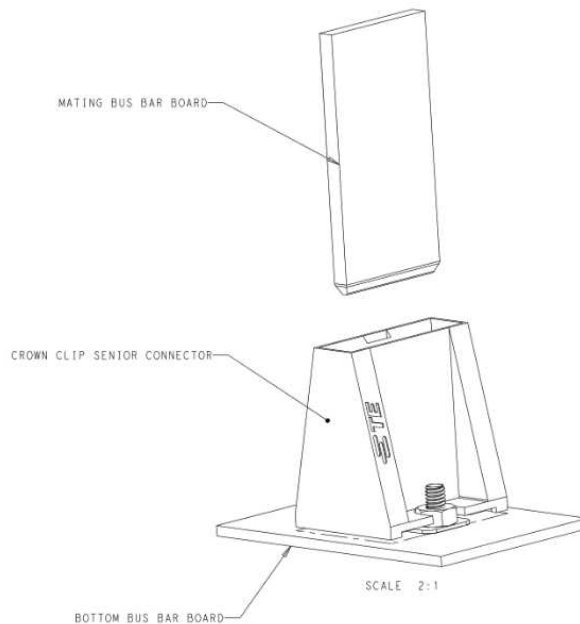

Figure 1 The Reference Product View of TE Crown Clip™ Senior Power Connector series

2. REFERENCE MATERIAL

2.1. Revision Summary

Initial release of Application Specification includes:

Updated document to corporate requirements.

2.2. Customer Assistance

Reference Product Part Number in product code 1080 are representative of TE Crown Clip™ Senior Power Connector series.

TE P/N: 1643906-1 TE Crown Clip™ Senior Single Pole Power Connector, Gold Plating Version.

TE P/N: 1926671-1 TE Crown Clip™ Senior Dual Pole Power Connector, Gold Plating Version.

TE P/N: 1926671-2 TE Crown Clip™ Senior Dual Pole Power Connector, Silver Plating Version.

TE P/N: 1643903-1 TE Crown Clip™ Senior II Power Connector, Gold Plating Version.

TE P/N: 1643903-2 TE Crown Clip™ Senior II Power Connector, Gold Plating/Low Force Version.

TE P/N: 1643903-3 TE Crown Clip™ Senior II Power Connector, Silver Plating Version.

Use of these numbers will identify the product line and help you to obtain product and tooling information. Such information can be obtained through a local Representative, by visiting our website at www.te.com, or by calling PRODUCT INFORMATION at the numbers at the bottom of page 1.

2.3. Drawings

Customer Drawings for product part numbers are available from the service network. If there is a conflict between the information contained in the Customer Drawings and this specification or with any other technical documentation supplied, the information contained in the Customer Drawings takes priority.

2.4. Specifications

Production Specification as below provide expected product performance and test information.

108-128066 Product Specification of TE Crown Clip™ Senior Power Connector

501-128067 Qualification Test Report of TE Crown Clip™ Senior Power Connector

2.5. Standards

- EIA-364: Electrical Connector/Socket Test Procedures Including Environmental Classifications
- 109-197: Test Specification (TE Connectivity Test Specification vs EIA Test Methods)
- Open Rack Standard V2.0, Open Compute Project

3. REQUIREMENTS

3.1. Safety

Do not stack product shipping containers so high that the containers buckle or deform.

3.2. Material

The insulation housing is made of thermoplastics, flammability class UL94 V-0, and the contacts are made of high conductivity copper alloy, gold plating, or silver plating over nickel base-plated at product contact area, detail please refer to the customer drawing.

3.3. Storage

A. Ultraviolet Light

Prolonged exposure to ultraviolet light may deteriorate the chemical composition used in the cable connector material.

B. Shelf Life

The connector or components should remain in the shipping containers until ready for use to prevent deformation to the contacts. The connector or components should be used on a first in, first out basis to avoid storage contamination that could adversely affect performance.

C. Chemical Exposure

Do not store connector or components near any chemical listed below as they may cause stress corrosion cracking in the contacts.

Alkalis	Ammonia	Citrates	Phosphates	Citrates	Sulfur Compounds
Amines	Carbonates	Nitrites	Sulfur	Nitrites	Tartrates

3.4. Recommended Bus Bar Board

TE Crown Clip™ Senior Power Connector is designed to mate with the solid Mating Bus Bar Board for single pole application, or Laminated Mating Bus Bar Board for specific product's dual-Pole application.

On the product bottom, connector is screw-mounted with bottom bus bar board, flexible bus bar, or PCB, in accordance with the actual application.

A. Material

For the optimum performance, the bus bar board must be made of highly conductive copper (101% @ 20°C [68°F] according to International Anneal Copper Standards {IACS}), such as C10100, C10200, C11000, etc.



The bus bar may NOT be made of aluminum.

B. Plating

Plating Specification of Mating Bus Bar Board:

Version I: Gold Plating over 1.27~7.6um Matte Nickel under-plating on bus bar copper contact surface.

Version II: 3.0~8.9um [.000120 to .000350 inch] Bright Silver Plating over 1.27~7.6um [.000050 to .000350 inch] Matte Nickel under-plating on bus bar copper contact surface

It's recommended to take 5~15mm wide selective gold or silver plating on bus bar contact interface.

Plating Specification of Bottom Bus Bar Board, Flexible Bus Bar, or PCB:

0.76~8.9um [.000030 to .000350 inch] Tin plating over 1.27~ 8.9 um [.000050 to .000350 inch] matte nickel base-plating on bus bar copper contact surface.

C. Bus Bar Board Design

The bus bar must be rigidly constructed and capable of preventing movement that could cause stubbing or misalignment of the contact with the bus bar.

Solid and Laminated Mating Bus Bar Board total thickness must be $3.175 \pm 0.05\text{mm}$, $3.175 + 0.05 / - 0.22\text{mm}$ for specific part number, detail please refer to TE customer drawing, and the recommended middle insulation layer thickness is $1.0 \pm 0.05\text{mm}$.

Bottom Bus Bar Board, Flexible Bus Bar, or PCB thickness: 3.0mm ref., 2.0~6.0mm.

D. Mating Edge Treatment:

The recommended guide chamfer feature of Mating Bus Bar Board is $2.0 \times 1.0\text{mm}$, $1.0 \times 1.0\text{mm}$ min. per actual application.

The leading edge must have a full radius or a gradual taper to provide a lead-in and ease mating of the connector with the bus bar.

All the dimension shall be in accordance with customer specific application requirement.

Detail please refer to the below Bus Bar Figure.

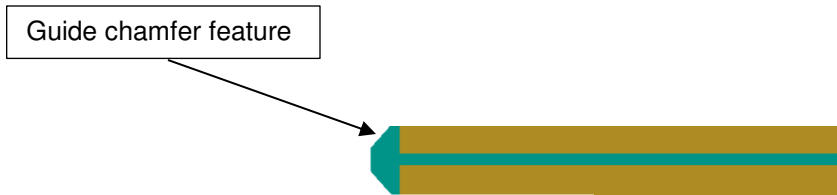

Figure 2. Recommended guide chamfer feature ($2.0 \times 1.0\text{mm}$) view of Laminated Mating Bus Bar Board.

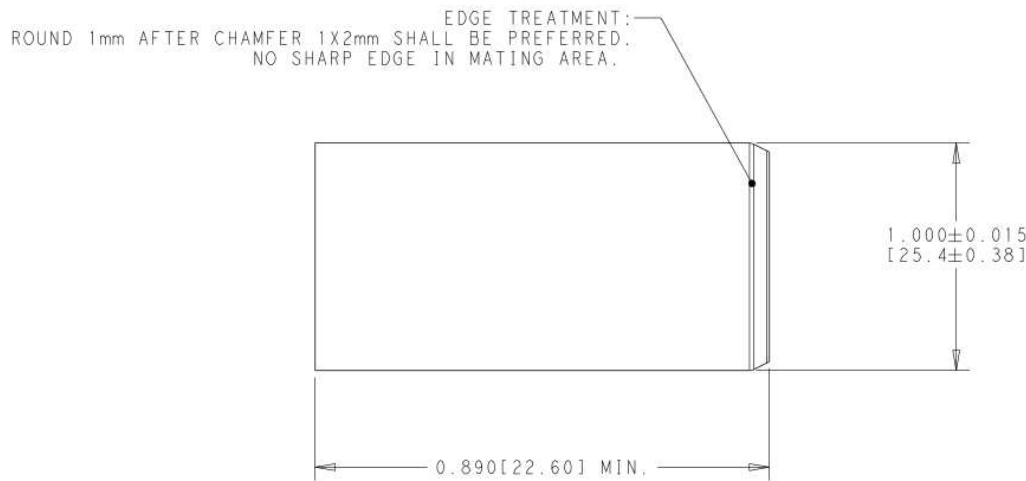

Figure 3. Solid or Laminated Mating Bus Bar Board View.

E. Bottom Bus Bar Board Layout:

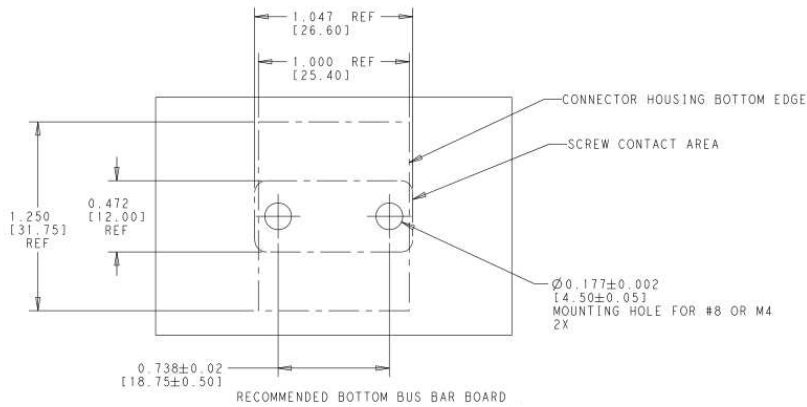

Figure 4. Bottom Screw-Mounting Bus Bar Board Layout View of P/N: 1643906-*

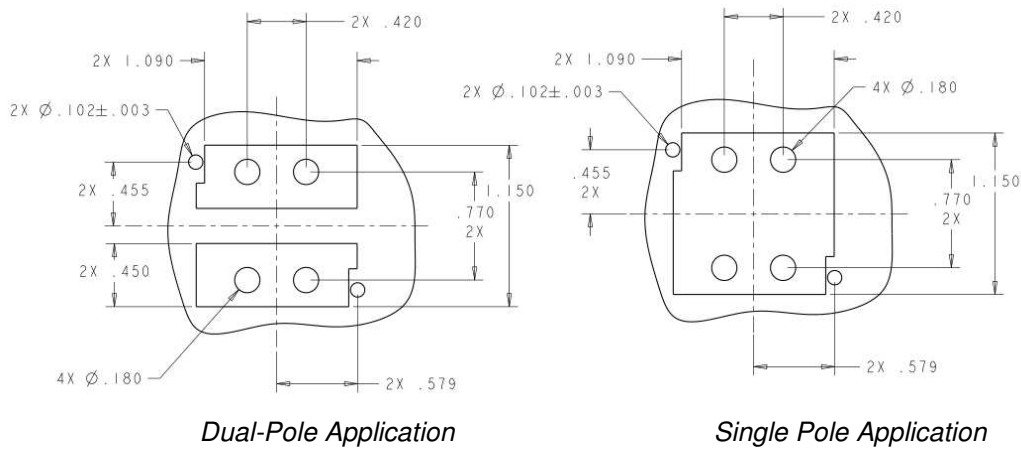

Figure 5. Bottom Screw-Mounting Bus Bar Board Layout View of P/N: 1926671-*

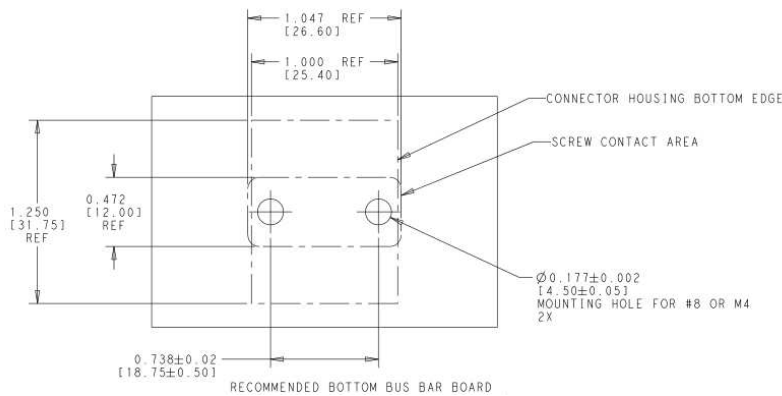

Figure 6. Bottom Screw-Mounting Bus Bar Board Layout View of P/N: 1643903-*

3.5. Mating

A. Mating Length

General mating length is 18.0~25.4mm, and it could be extended to 30mm for P/N: 1643903-* and 1926671-*, when Inserting Bus Bar Board into connector.

B. Misalignment

Misalignment capability: $\pm 2.0\text{mm}$.

C. Mating/Un-mating Force

Please refer to Product Specification, and Qualification Test Report, general mating force Spec. 100N max. and unmating force 8N min.

D. Rack system misalignment.

The steel guide module is recommended to assemble with Rack Node, to improve the misalignment capability of Rack system. The tolerance between guide pin and guide hole or module, is always recommended to be $\pm 0.25\text{mm}$ ref. TE P/N: 223969-1.



Figure 7. Reference Guide module View.

3.6. Repair

These connectors are not repairable. Damaged or defective connectors must not be used.

4. HARDWARE

TE Crown Clip™ Senior Single Pole Power Connector shall be screw-mounted with bottom bus bar board with M4*0.7 or #8-32 Screw and Nut, 2pcs for TE P/N: 1643906-* and 1643903-*, and 4pcs for TE P/N: 1926671-*. the recommended torque 10~15Kgf.cm. Refer to the reference application view.

TE screw P/N: 1-2204893-1, Low head hex screw M4*0.7.



Figure 8. Reference Hardware View.

5. VISUAL AID

The below illustration shows a typical application of Pluggable Bus Bar Power Connector. This illustration should be used by production personnel to ensure a correctly applied product. Applications which DO NOT appear correct should be inspected using the information in the preceding pages of this specification and in the instructional material shipped with the product or tooling.

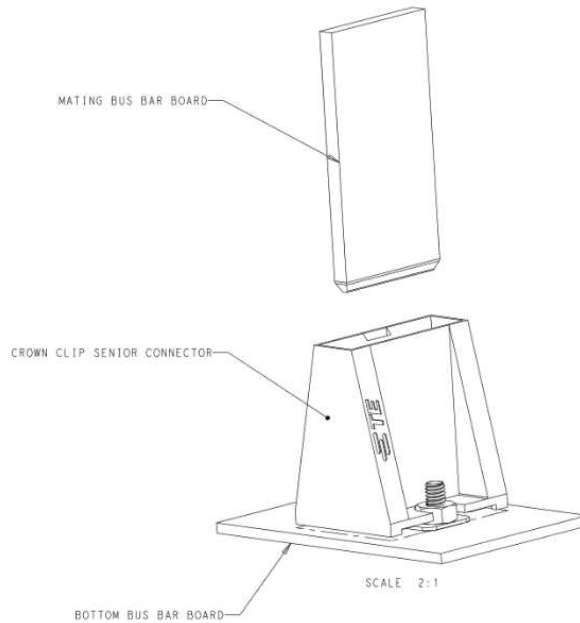

Figure 9. Visual Aid of TE Connectivity (TE) Crown Clip™ Senior Power Connector Series