



The product described in this document has not been fully tested to ensure conformance to the requirements outlined below. Therefore, TE Connectivity (TE) makes no representation or warranty, express or implied, that the product will comply with these requirements. Further, TE may change these requirements based on the results of additional testing and evaluation. Contact TE Engineering for further details.

Title	WIRE COVER FOR OPU 5P PLUG ASS'Y
--------------	---

1 MECHANICAL FUNCTION

[1] PART INFORMATION

[2] Scope

[3] Quality

[4] Requirements Measuring Method

4.1) Instant short circuit

[5] Test Method

5.1) Appearance

5.2) Cold temperature test

5.3) Temperature and humidity cycle test

5.4) Complex environment endurance test A

[6] Test conditions

6.1) specimen

6.2) Laboratory condition

6.3) Basic current

6.4) Evaluation

6.5) Cable size

2 MATERIAL

[1] SCOPE

[2] LABORATORY CONDITION

[3] SPECIMEN

[4] HEAT AND HUMIDITY CYCLE RESISTANCE TEST – TYPE C

[5] WEATHERABILITY TEST

[6] VIBRATION RESISTANCE TEST

[7] WATER RESISTANCE TEST

[8] CHEMICAL RESISTANCE

[9] IMPACK RESISTANCE

3 HISTORY AND APPROVAL

1 MECHANICAL FUNCTION

[1] PART INFORMATION

Part number	Description
2109265	WIRE COVER FOR OPU 5P PLUG ASS'Y

[2] SCOPE

This specification defines the test method for cover.

[3] Quality

The quality of covers are implemented test with accept or failure without acceptable value.

[4] Requirements Measuring Method

4.1) Instant short circuit

It is instant short circuit, when 3.5V or less voltage continues for 10 μ s or more in gauge by applying 1mA, 5V open voltage. Figure 4-1 is an example of measured circuit.

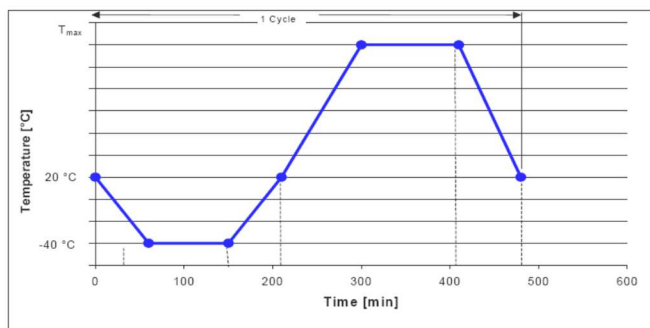

Duration Min	Temperature °C
0	20
60	-40
150	-40
210	20
300	T _{max} * (see table 4-2)
410	T _{max} * (see table 4-2)
480	20

<Table 4-1>

Division	High temperature (*)	Connector using part
A	120°C	ENG room
B	80°C	except ENG room

< Table 4-2 >

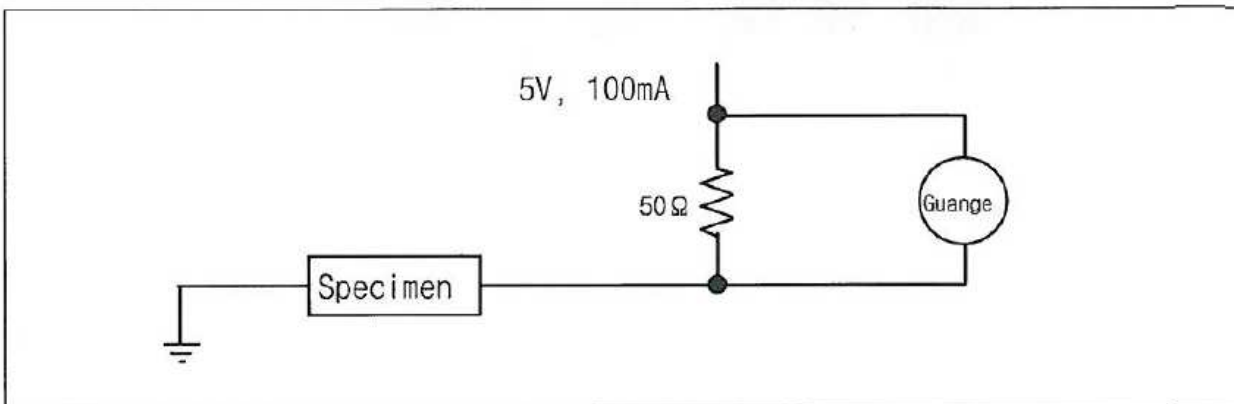

<Fig. 4-1>

[5] Test Method

5.1) Appearance

- A) By sense of sight and touch

5.2) Cold temperature test

- A) Leave connector with terminal assembled in temperature chamber of -40°C for 120 hours and estimate below items for each sample dividing two groups.
 - a) Estimate voltage drop and leakage current assembled connector.
 - b) Leave connector for 2 hours and separate connector with male and female, and then drop it onto the concrete surface more than 10T from 1.5m height 3 items. The method of connector drop follows figure 5-1.

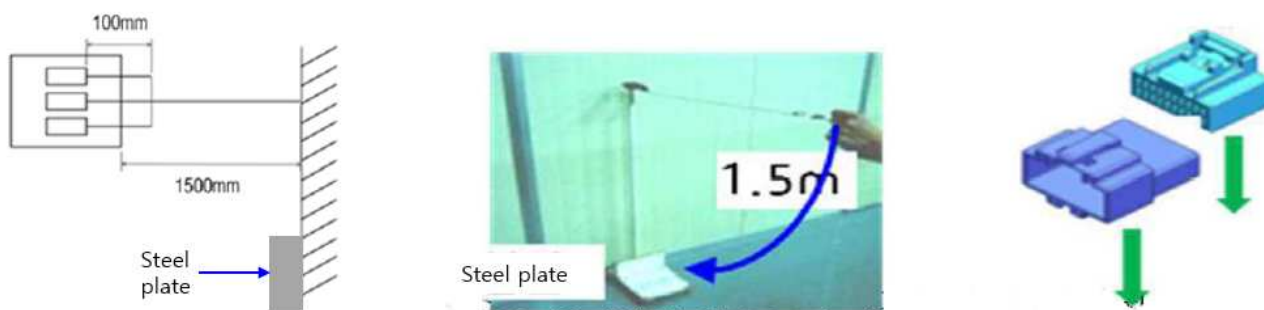

< Fig. 5-1 >

5.3) Temperature and humidity cycle test

- A) Engage and disengage connector with terminal assembled 10 times with hands, and leave it at 25°C ambient temperature and 65% relative humidity for 25 hours. And perform 5cycles of the method specified in figure 5-2. Then pick connector out of chamber and dry it for 2 hours or more.

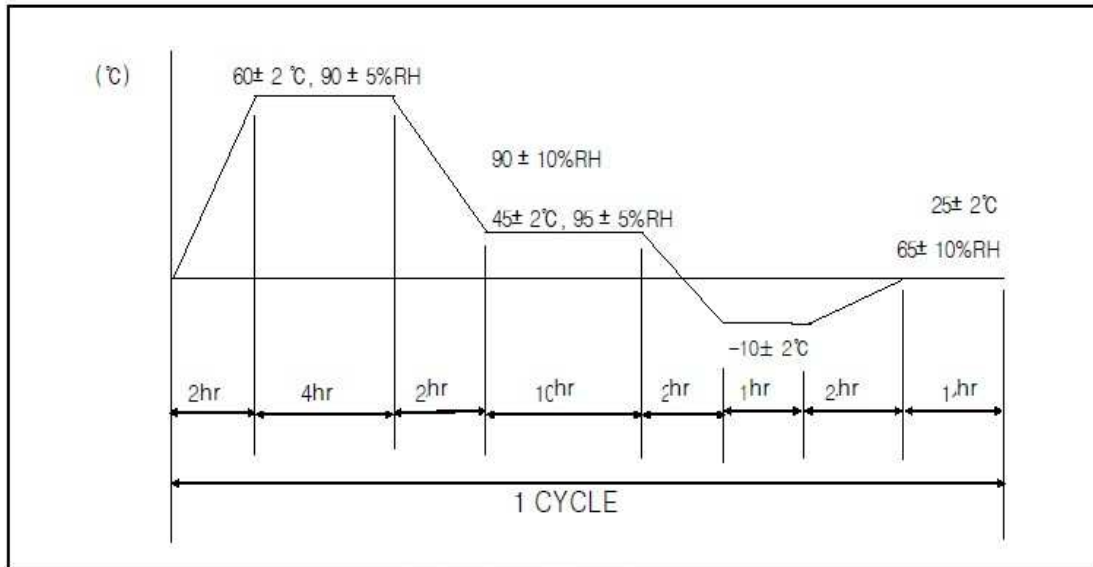

< Fig. 5-2 >

5.4) Complex environment endurance test A (Refer to the attached test process #1)

- A) Engage and disengage connector with terminal assembled 10 times with hands, and leave it in combined state in the temperature chamber of 120°C or 80°C (follows table 7) for 48 hours.
 And then perform the following vibration test. Then measure instant short circuit according to the method of clause 4.1 for 4 hours for X, Y, Z each.
 Follow figure 5-3 for connector attaching method.

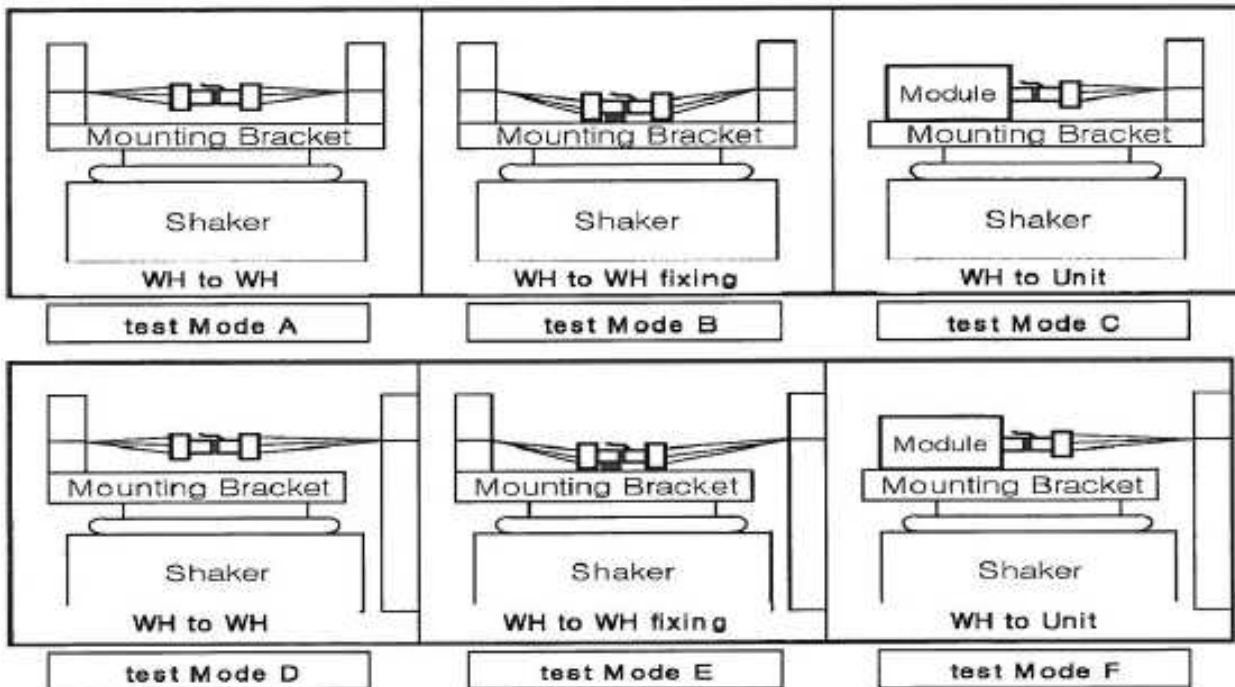

< Fig 5-3 Connector attaching method >

◆ Vibration test B (for waterproof connector)

Division	Condition
Ambient temperature/humidity	Refer to figure 12, 90~95%
Applied current	Basic current (Connector electrodes in series.)
Current application cycle	120 CYCLE (45 minutes-ON, 15 minutes-OFF)
Vibration acceleration	Refer to figure 4-5
Frequency	20Hz ~ 200Hz (sweep time: 3 minutes or less)
Vibration time	40 hours for X, Y, Z each
Connector attaching method	Test mode A, B, C

< Table 5-1 >

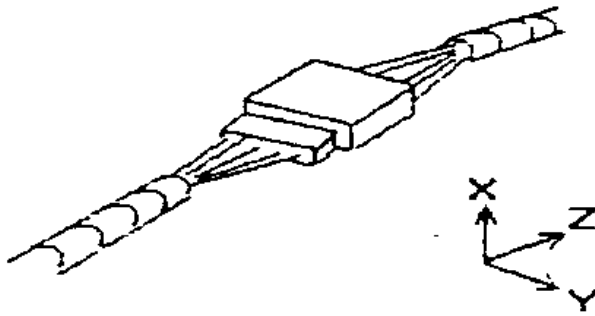

<Fig. 5-4 : X, Y, Z vibration direction>

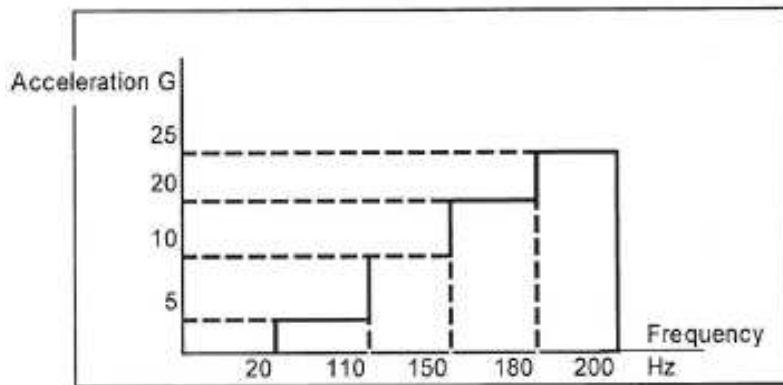

<Fig. 5-5>

Test process #1

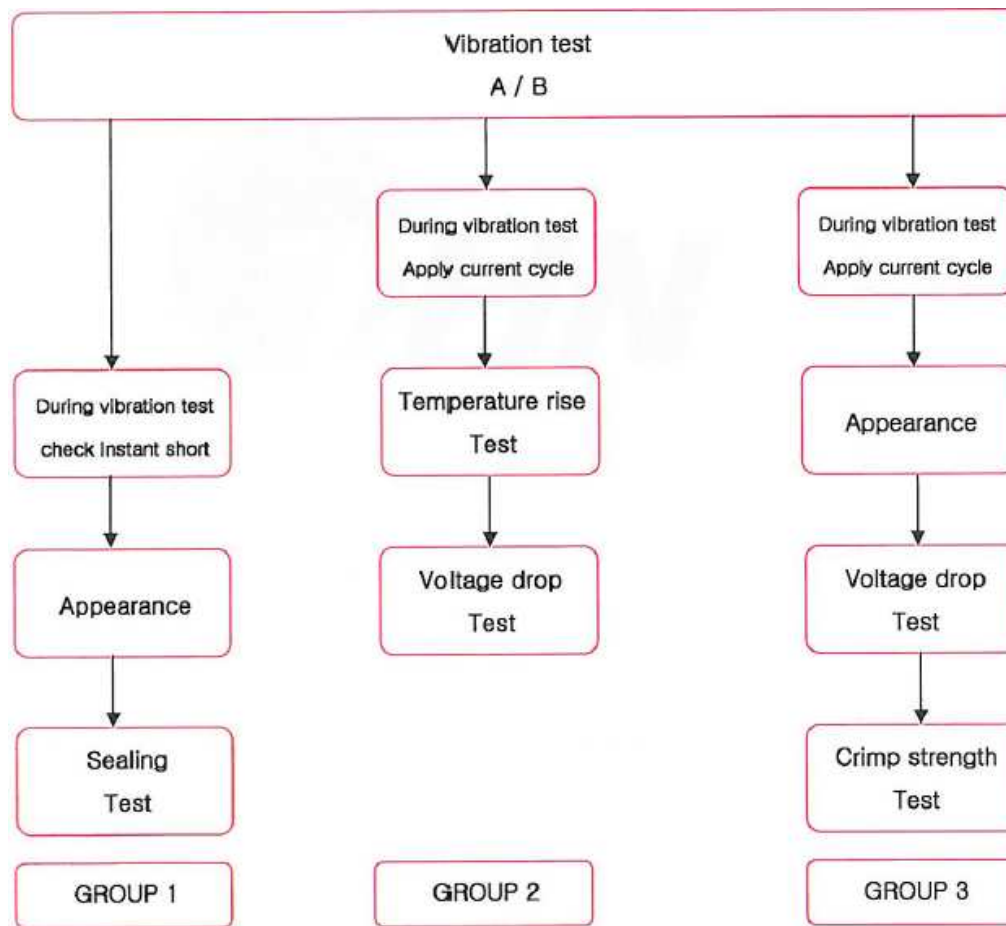

※ In the multipolar connector, Evaluation test at the same time for group 2/3

[6] Test conditions

6.1) Specimen

Unless there is specific mention, initial sample should use for the test specimen, and test specimen shall be 5EA or more for each cavity. However, if performance is expected to be clearly satisfactory ever by applying load to the same specimen in turn, it is possible to apply multiple test items to the same specimen. In such case, performance shall be satisfied with each item.

6.2) Laboratory condition

Perform each test at designated temperature and humidity. And control humidity at designated absorption ratio for the connector which uses absorbent resin housing.

Temperature: 25 ± 5 °C

Humidity: 60 ± 20 %

Standard absorption ratio (reference value)

6 NYLON: 2 ~ 4%

66 NYLON: 1.5 ~ 3%

6.3) Basic current

Basic current value “I” shall be based on the following. ($I = I_0 * K$)

Cable size (SQ)	I ₀		Remarks
	General	L TYPE -375	
0.22	4 A		
0.3	6 A		4A for signal
0.5	8 A		5A for signal
0.85	10 A		
1.25	14 A		
2	18 A		
3	22 A	34 A	
5	25 A	46 A	
8		60 A	

< Table 2 >

Number of simultaneous electrode within the same connector	K
	Reduction factor
1	1
2 ~ 3	0.75
4 ~ 5	0.6
6 ~ 8	0.55
9 ~ 10	0.5
11 ~ 25	0.4
26 or more	0.3
-	-

< Table 3 >

6.4) Evaluation

Evaluation shall be represented by evaluation applicable connector. And Annual evaluation of connectors shall be represented by evaluation of connectors of the maximum number of poles in the same series.

6.5) Cable size

The size of connector lead wire used in each test shall be follow Table 5.

Test Item		MIN WIRE	MAX WIRE	Test Item		MIN WIRE	MAX WIRE
Cold temperature Test	Appearance	-	○	Temperature and humidity cycle test	Voltage Drop	-	○
	Voltage Drop	-	○		Insulation resistance	○	○
	resistance		○		Leakage current	-	○
	Leakage current	-	○		Sealing	○	○
	Temperature rise	-	○				
	Sealing	○	○				
Complex environment Endurance test	Crimp strength	○	○				
	Voltage Drop	-	○				

	Temperature rise	-	0			
	Instant short circuit	-	0			
	Sealing	0	0			

< Table 5 >

2 MATERIAL

[1] SCOPE

This test specification covers a general efficiency for the plastic product applying engine room.

[2] LABORATORY CONDITION

Perform each test at designated temperature and humidity.

Temperature: 23 ± 2 °C

Humidity: 50 ± 5 %

[3] SPECIMEN

Specimen shall be selected from finished products or equivalents made under the same conditions with the finished products. The test products shall keep in standard laboratory condition for 24 hours and then assembled in regular using condition.

Note (4) fixed on the B.I.W or test jig as assembled in the real vehicle.

[4] HEAT AND HUMIDITY CYCLE RESISTANCE TEST - TYPE C

Repeat 3 times with designated condition Figure 1.

Apply the heat and humidity cycle resistance test - TYPE C for the plastic product which is to install around the engine room and to be affected by high temperature such as radiant heat or convection in engine room.

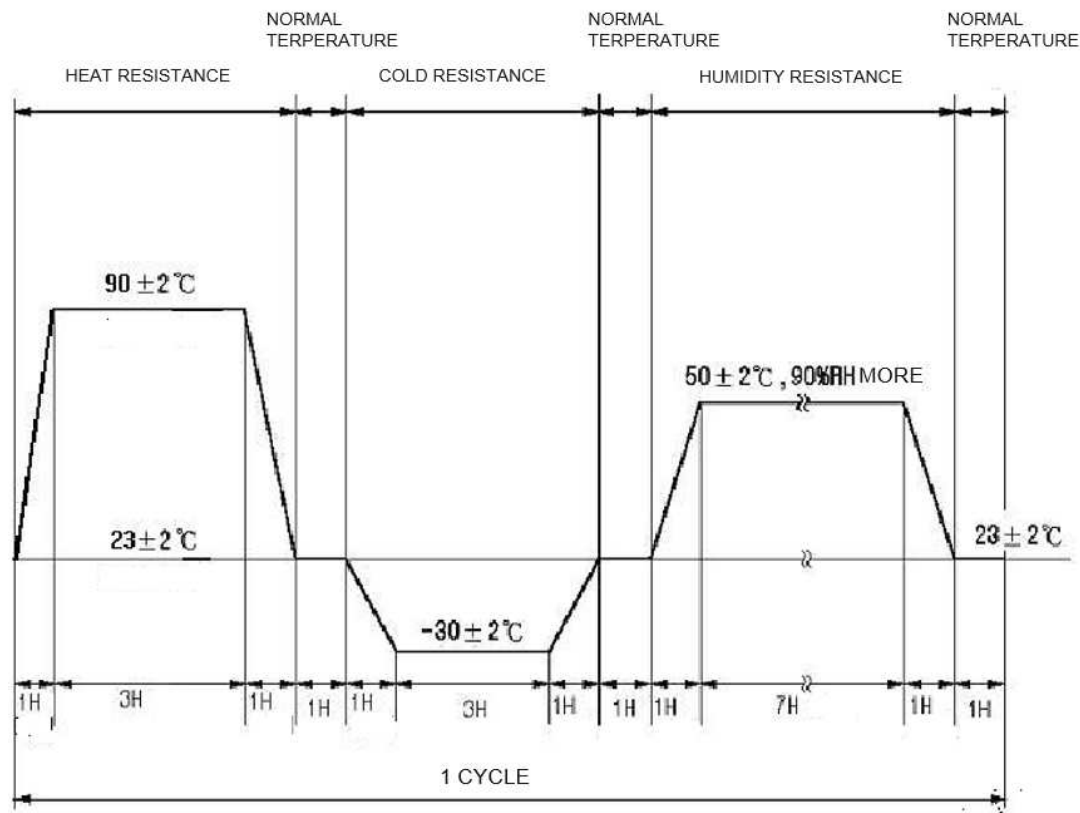

FIGURE 1

[5] WEATHERABILITY TEST

Apply weather-o-meter (Xenon arc described in ISO 105, JIS L 0843, ASTM D 6695, SAE J 1960, SAE J 2527) with the test condition in Table 1 for 500 hours.

RADIANT EXPOSURE	BLACK PNL TEMPERATURE	CYCLE	SPECTRAL IRRADIANCE
660KJ/ m ² [340nm]	70 ±2 °C (LIGHT) 38 ±2 °C (DARK)	40 min (50 ± 5 %RH) 20 min (water spray on the surface) 60 min (50 ± 5 %RH) 60 min (95 ± 5 %RH, water spray on front/back surface)	0.55 ± 0.02 W/(m ² •nm) [340 nm]

TABLE 1

[6] VIBRATION RESISTANCE TEST

Apply 33 Hz (1980 cycle/MIN) of vibration frequency and 32 m/s² (3.3G) of vibration speed with the direction of upward-downward for 4 hours, leftward-rightward for 2 hours and forward-backward for 2 hours.

[7] WATER RESISTANCE TEST

Dip the sample into $40 \pm 2^\circ\text{C}$ water bath for 240 hours, then clean the surface. Use an air blower to drain and dry it and leave the specimen under the test condition as specified 2.[1] for an hours.

[8] CHEMICAL RESISTANCE

*. CHEMICAL TYPE : Gasoline, Paint-protect was, Was remover, Brake fluid, Anti-freezer, Engine oil, Wind shield washer, Gloss was, Solvent including Benzene or Toluene, Thinner, Nonflammable washer.

8.1) WIPPING Test

Wet the surface using 250 X 250 mm horizontally and vertically folded medicine gauze with 5 ml of chemicals fully as mentioned chemical type and then leave it for 30 minutes under the test condition as specified 2.[1].

Apply the heat and humidity cycle resistance test - TYPE A as shown Figure 2 to it for 1 cycle and remove the chemical.

8.2) SPOT Test

Use the dropping pipet to drop 0.2 ml to chemical as mentioned chemical type on the surface and leave it for 1 hours under the test condition as specified 2.[1].

Apply the heat and humidity cycle resistance test – TYPE A as shown Figure 2 to it for 1 cycle and remove the chemical.

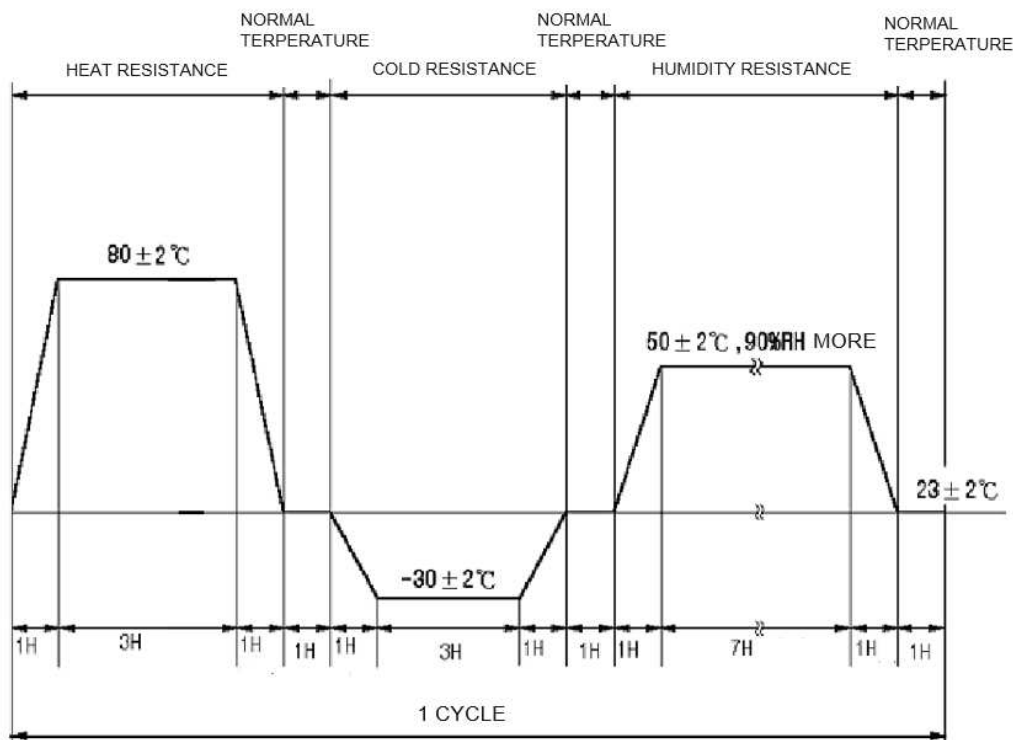

FIGURE 2

[9] IMPACK RESISTANCE

9.1) Normal Temperature

Set the assembled sample with regular using condition to be facing-up and parallel to upward. Drop the iron ball to keep the specified energy in below Table 2.

9.2) Low Temperature

Drop the iron ball for 3 times after -30°C for 3 hours.

ASSEMBLE LOCAATION ON VEHICLE	TEST TEMPERATURE	IMPACT ENERGY
FRONT PART (EXCEPT BUMPER)	23 ± 2 °C, -30 ± 2 °C	1.47 J
UPPER SIDE PART	23 ± 2 °C, -30 ± 2 °C	0.98 J
LOWER SIDE PART	23 ± 2 °C, -30 ± 2 °C	1.96 J
REAR PART (EXCEPT BUMPER)	23 ± 2 °C, -30 ± 2 °C	0.98 J

TABLE 2

3 HISTORY AND APPROVAL

Rev	Change	Description	Date
A		Initial Released	15.MAR.'22

Prepared by,	Checked By,	Approved by
CI JEON	KT JUNG	YJ YOUN
Product Engineer	Senior Product Engineer	Product Engineering Manager