

RELAYS HOLDERS

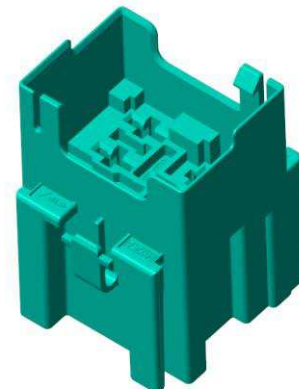
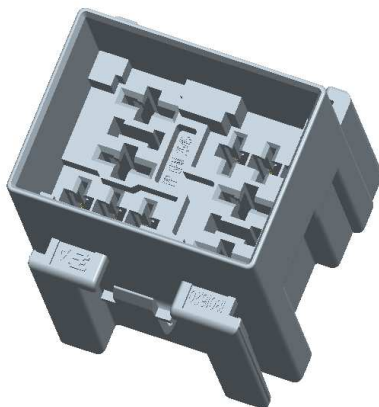
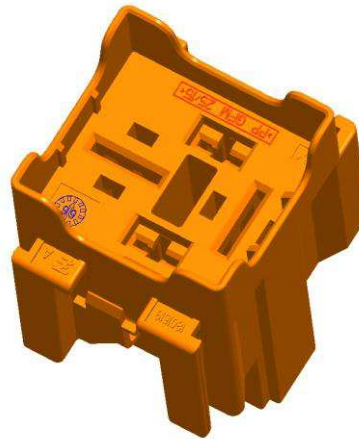
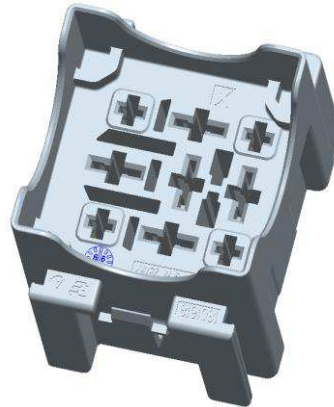

Rédigé par/*Drawing by* : O.Bouillot

le 15-March-2019

Approuvé par/*Approved by* : I.SMIRANI 15-March-2019

Tyco Electronics France SAS
1 rue Ampère,
95300 Pontoise

©2005 Tyco Electronics Corporation
All International Rights Reserved
(Tous droits réservés)

1 of 21

Ce document est sujet à modifications. Contacter Tyco Electronics pour identifier la dernière révision et en obtenir une copie. Personnel Tyco Electronics France : consultez la base de données Startec.

This document, managed by Tyco Electronics France, is archived in the Startec database.

A printout cannot be considered as a controlled document

TABLE DES REVISIONS – *REVISION TABLE*

Revision	Date	Modification
1	31/01/2011	Initialisation
2	11/02/2011	Update
A	04/07/2012	Change Tyco Electronics for TE Connectivity Modification of requirements for test M1, M3, M6, M7 & O1 Clarification of requirement for test E1
B	15/03/2019	Adding new reference 2 MICRO RELAY HOLDER for NISSAN Adding specific DVP for 2 MICRO RELAY HOLDER for NISSAN

CONTENTS:



1. SCOPE	4
2. DESCRIPTION	4
2.1. Relay Holder	4
2.2. References	4
2.3. Electrical synoptic: see appendix 1	4
2.4. Wiring architecture: see appendix 2	4
2.5. Contacts used in the Relay Holders	5
3. REFERENCE DOCUMENTS	5
3.1. Usable document	5
3.2. Tyco Electronics specifications	5
3.3. Customer specifications (Renault)	5
4. OPERATING CONDITIONS	6
4.1. Temperatures	6
4.2. Watertightness & Protection rating	6
4.3. Vibration	6
4.4. Load scenario current at 85°C:	6
5. TESTS	6
5.1. Test conditions:	6
6. QUALITY INSURANCE MEASURE	11
6.1. Qualification test	11
6.2. Program approval tests	12
6.2.1. Renault Holders	12
6.2.2. Nissan Holders	13
6.3. General conditions of test	14
6.4. Test and conformity	14
Appendix 1 : Relays rating	15
Appendix 2 : Wiring architecture	16
Appendix 3 : Current load scenarios at 85°C	17
Appendix 4: Vibration profil	18
Appendix 5: Temperature humidity cycle	19
Appendix 6: Table of test configuration for inter boxes mechanical tests	20

1. SCOPE

This document covers the performances, tests, and quality requirements for Relay Holders.

2. DESCRIPTION

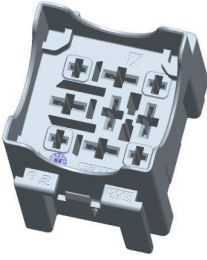
2.1. Relay Holder

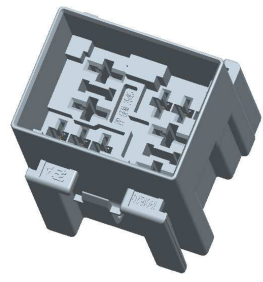
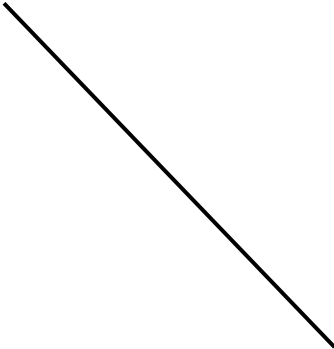
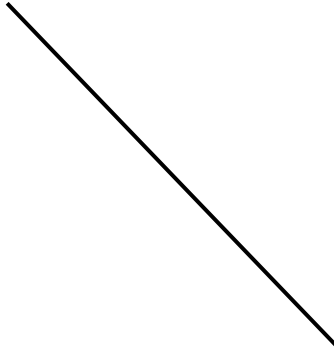
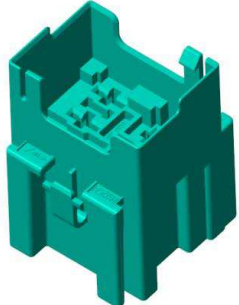
	Relay ISO 40A Holder	Relay ISO 70A Holder	μ-Relays Holder
Renault Relay Holder			
Nissan Relay Holder			

2.2. References

Customer	Tyco Electronics P/N	Description
Renault	1801618-1	Relay ISO 40A Holder
	1801619-1	Relay ISO 70A Holder
	1801620-1	2 Micro-Relays Holder
Nissan	1802257-1	2 Micro-Relays Holder

2.3. Electrical synoptic: _____ **see appendix 1**

2.4. Wiring architecture: _____ **see appendix 2**

2.5. Contacts used in the Relay Holders

Clip, tab description	Wire	Tyco Electronics P/N	Use
Clip JPT Type A	0,2 ² to 0,5 ²	0-964280-2 0-964280-1	Micro Relay
Clip JPT Type A	0,5 ² to 1 ²	0-964284-2 0-964284-1	Micro Relay
Clip JPT Type A	1.5 ² to 2.5 ²	0-965999-2	Micro Relay * and 40A Relay Holder
Clip JPT Type A	2.5 ² to 4 ²	0-1241978-2	40A Relay Holder
Clip SPT	0.5 ² to 1 ²	0-0927831-2	Micro, 40A, 70A relays
Clip SPT	1 ² to 3 ²	0-0144617-1	Micro, 40A, 70A relays
Clip SPT	3 ² to 5 ²	0-0144433-1	Micro, 40A, 70A relays
Clip MPT	2.5 ² to 4 ²	0-0962928-1	For 70A relays
Clip MPT	4 ² to 6 ²	0-0962930-1	For 70A relays
Clip MPT	7 ² to 10 ²	0-0962932-1	For 70A relays

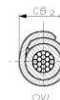

* For Micro relay, the crimping width on insulation (CB2) must not exceed 3.7mm

3. REFERENCE DOCUMENTS

3.1. Usable document

In the event of conflict between the requirements of this specification and the drawing, the drawing shall take precedent.

In the event of conflict between the requirement of this specification and the referenced documents, this specification shall take precedent.

3.2. Tyco Electronics specifications

108-18013 rev E	JPT contact
108-18025 rev G	SPT contact
108-15122 rev A	SPT contact
108-18047 rev C	MPT contact

3.3 Customer specifications (Renault)

36-05-219/--C	Wired part for relay and / or fuses.
36-05-019/--G	Electrical connections and connectors.
36-05-019/--E	Electrical connections and connectors.
36-05-205/--E	Flat fuses with connector blades
36-05-210/--C	Plastic connector supports and protectors for electrical wiring assemblies and wiring components.
36-05-217/--A	Relay with diode
36-05-046/--	Relay with resistor

4. OPERATING CONDITIONS

4.1. Temperatures

Class(*)	Operating temperature	Test temperature *	
3	-40°C to 125°C	+150°C	For electrical connection area
2	-40°C to +100°C	+125°C	For locking devices

(*): Without current load

4.2. Watertightness & Protection rating

- Watertightness: Class 0 - Unsealed

4.3. Vibration

- Class 1 : application on car body

4.4. Load scenario current at 85°C:

- See appendix 3

5. TESTS

5.1. Test conditions:

- Supply voltage: 13.5V ± 0.5V
- Ambient temperature: 23°C ± 5°C
- Relative humidity: 60%± 15%
- Atmospheric pressure: 96kPa ± 10kPa
- If not otherwise specified mechanical test: v = 50 mm/min
- Different configurations are defined: the table below gives the configuration of each relays holders

Configuration	Plastic boxes	Wired Contact	Relays
A	X		
B	X	X	
C	X	X	X

GENERAL INSPECTION				
	Test description	Ref. RSA For indication	Procedure	Requirement
RELAYS HOLDERS				
V1	Visual inspection	36-05-019 /--G § 6.1	Shall be performed with the naked eye.	No working damages No visible damage, cracking or defect.
MECHANICAL TESTS				
	Test description	Ref. RSA For indication	Procedure	Requirement
RELAYS HOLDERS				
M1	Insertion force inter boxes	36-05-219 /--C § 7.2.4.1	→ Relays Holders in configuration A Make test according table 1 (see appendix 6)	F < 60N
M2	Removal force inter boxes	36-05-219 /--C § 7.2.4.1	→ Relays Holders in configuration A Make test according table 1 (see appendix 6)	F < 60N
M3	Retention force inter boxes	36-05-219 /--C § 7.2.4.1	→ Relays Holders in configuration A Make test according table 1 (see appendix 6)	F > 120N F > 100N for µrelays Holder
M4	Shock impact test	36-05-019 /--G § 6.21	→ Relays Holders in configuration A Impact hammer weight: 300gr Falling height: 100 mm The impact test described in NF R 13-415 Impact zone see appendix 6	<ul style="list-style-type: none"> ▪ Visual examination: ▪ No break, cracking nor deformation
M5	Drop resistance	36-05-019 /--G § 6.22	→ Relays Holders in configuration A and configuration C 1m free fall test, on each face, on concrete floor. Test temperature: 0 °C	No incipient rupture but unconcealed damage permissible

CONTACTS				
M6	Terminal insertion force	36-05-019 /--G § 5.3.4	<p>➔ Relays Holders in configuration A</p> <p>Two insertion force measurement possible:</p> <ul style="list-style-type: none"> . 1) Validation performed on a machine with a mobile jaw displacement speed of 50 mm/min ± 5 mm/min. . 2) The connector, installed on the measurement fixture, is manually loaded. The force is recorded at each insertion. 	<ul style="list-style-type: none"> ▪ Clip JPT 2.8 ≤ 10 N ▪ Clip SPT 4.8 ≤ 15 N ▪ Clip SPT 4.8 ≤ 20 N for 5mm² wire ▪ Clip MPT ≤ 55 N
M7	Terminal retention force	36-05-019 /--G § 5.3.5	<p>➔ Relays Holders in configuration A</p> <p>The same measurement technique is used as the method described in M6 "terminal insertion". Under no circumstances must the mechanical strength of the wire be used as a reference.</p>	<ul style="list-style-type: none"> ▪ Clip JPT 2.8 > 100 N ▪ Clip SPT 4.8 > 120 N ▪ MPT > 150 N <p>After the ageing tests:</p> <ul style="list-style-type: none"> Clip JPT 2.8 > 72 N Clip SPT 4.8 > 72 N MPT > 90 N
RELAYS				
M8	Relays insertion force	36-05-219 /--C § 7.2.4.2	➔ Relays Holders in configuration B	<p>Relay insertion force :</p> <ul style="list-style-type: none"> ▪ Micro: F ≤ 85N ▪ 40A: F ≤ 100N ▪ 70A: F ≤ 120N
M9	Relays uncoupling force	36-05-219 /--C § 7.2.4.2	➔ Relays Holders in configuration B	<p>Relay uncoupling force :</p> <ul style="list-style-type: none"> ▪ Micro: 30 ≤ F ≤ 115N ▪ 40A: 40 ≤ F ≤ 100N ▪ 70A: 40 ≤ F ≤ 120N
M10	Durability insertion and uncoupling components	36-05-219 /--C § 7.2.4.4	<p>➔ Relays Holders in configuration B</p> <p>Mount and remove each relay 10 times.</p> <ul style="list-style-type: none"> - With 50% of the samples with the same component - With 50% of the samples with new component for each operation <p>Record the first and the tenth:</p> <ul style="list-style-type: none"> ▪ Mounting and removing forces ▪ Contact resistances 	<ul style="list-style-type: none"> ▪ Component insertion force (see M8) or/and the decrease must be lower than 10% of the 1st operation ▪ Component removing force (see M9) or/and the decrease must be lower than 10% of the 1st operation ▪ Contact resistance Maxi (see E1)
M11	Protection of the contacts during the working and the handling	36-05-219 /--C § 6.4.4	<p>➔ Relays Holders in configuration B</p> <p>Mount and remove each relay 5 times in worst opposite combination clip/component.</p> <p>Record before and after the test:</p> <ul style="list-style-type: none"> ▪ Contact resistances ▪ Component removing forces 	<ul style="list-style-type: none"> ▪ Contact resistance Maxi (see E1) ▪ Component removing force: the decrease must be lower than 20% of the 1st operation
M12	Relays retention force (for information)	36-05-219 /--C § 7.2.4.2	➔ Relays Holders in configuration B only for PN 1802257-1	<p>Relay retention force:</p> <ul style="list-style-type: none"> ▪ Micro: F > 50N

ELECTRICAL TESTS				
	Test description	Ref. RSA <small>For indication</small>	Procedure	Requirement
E1	Contact resistance	36-05-219 /--C § 7.2.2 36-05-019 /--G § 6.2	➔ Relays Holders in configuration C “MilliVolts” level method: <ul style="list-style-type: none"> ▪ Test voltage: 20 mV ▪ Test current: 50 mA 	Initial contact resistance: <ul style="list-style-type: none"> ▪ Relays μ & 40A $\leq 6 \text{ m}\Omega$ ▪ Relays 70A $\leq 2 \text{ m}\Omega$ ▪ JPT 2.8 $\leq 3 \text{ m}\Omega$ ▪ Clip SPT 4.8 $\leq 3 \text{ m}\Omega$ ▪ Clip MPT $\leq 1 \text{ m}\Omega$ After the ageing tests: Relays μ & 40A $\Delta R_c \leq 8 \text{ m}\Omega$ Relays 70A $\Delta R_c \leq 2 \text{ m}\Omega$ JPT 2.8 $\Delta R_c \leq 4 \text{ m}\Omega$ SPT 4.8 $\Delta R_c \leq 4 \text{ m}\Omega$ MPT $\Delta R_c \leq 1 \text{ m}\Omega$
E2	Derating curve		➔ Test performed following norm IEC 60512-5	Tcontact < Tmax (125°C) Wire section tested: <ul style="list-style-type: none"> ▪ μRelay: 2 & 5mm² ▪ 40A: 3 & 5mm² ▪ 70A: 6 & 10mm²
E3	Insulation resistance	36-05-019 /--G § 6.11	➔ Relays Holders in configuration C Measures must be performed between each contact and between each contact connected together and a metal sheet covering the housing Voltage test : 500V dc / 1 min	Ri $\geq 100 \text{ M}\Omega$
E4	Voltage resistance	36-05-019 /--G § 6.12	➔ Relays Holders in configuration C 1 000 Vac eff. 50 Hz or 60 Hz (or 1400 Vcc) / 1 min between each contact and between each contact connected together and a metal sheet covering the housing	No dielectric breakdown or flash-over during the test. Contacts must be without damage, oxide trace, or all other defect Housing must be without damage
THERMAL ELECTRICAL TESTS				
	Test description	Ref. RSA <small>For indication</small>	Procedure	Requirement
T1	Current cycling at high temperature	36-05-219 /--C § 7.4 36-05-019 /--G § 6.15	➔ Relays Holders in configuration C In an oven at 85°C, the holder is powered: <ul style="list-style-type: none"> ▪ 500 cycles of scenario at 85°C (see appendix 3) 1 cycle: <ul style="list-style-type: none"> ▪ 45 min holder powered ▪ 15 min holder not powered 	<ul style="list-style-type: none"> ▪ Contact resistance (see E1)

AGEING TESTS				
Test description	Ref. RSA <small>For indication</small>	Procedure	Requirement	
A1 Atmospheric corrosion test	36-05-019 /--G § 6.7	<p>➔ Relays Holders in configuration C</p> <p>Method regarding CEI 68-2-60 with</p> <ul style="list-style-type: none"> ▪ Preconditioning: 1 H ▪ Method: C ▪ Duration: 4 h 	<ul style="list-style-type: none"> ▪ Contact resistance (see E1) ▪ Visual inspection 	
A2 Vibrations	36-05-019 /--E § 6.6	<p>➔ Relays Holders in configuration C</p> <p>Vibration: Class 1 see appendix 4</p>	<ul style="list-style-type: none"> ▪ During sequence 1: No breakdown above 1µs ▪ Contact resistance (see E1) 	
A3 Temperature humidity cycle	36-05-019 /--G § 6.16	<p>➔ Relays Holders in configuration C</p> <ul style="list-style-type: none"> ▪ Holder not powered ▪ 10 cycles of 24 Hrs. <p>Cycles described in appendix 5 Tmax=125°C</p>	<ul style="list-style-type: none"> ▪ Visual examination ▪ Contact resistance (see E1) ▪ Withstanding voltage ▪ Insulation resistance 	
A4 Thermal shocks	36-05-019 /--G § 6.17	<p>➔ Relays Holders in configuration C</p> <ul style="list-style-type: none"> ▪ Holder not powered ▪ 100 cycles (1 cycle : 1H/-40°C + 1H/+125°C) ▪ Transition time < 15s 	<ul style="list-style-type: none"> ▪ Visual examination ▪ Contact resistance (see E1) 	
A5 Climatic endurance	36-05-019 /--G § 6.19	<p>➔ Relays Holders in configuration C</p> <ul style="list-style-type: none"> ▪ Holder not powered ▪ 240 Hrs at 125°C 	<ul style="list-style-type: none"> ▪ No visible deformation nor crack ▪ Contact resistance (see E1) 	
A6 Climatic endurance (For information)	36-05-019 /--G § 6.19	<p>➔ Relays Holders in configuration B</p> <ul style="list-style-type: none"> ▪ Holder not powered ▪ 240 Hrs at 150°C 	<ul style="list-style-type: none"> ▪ No visible deformation nor crack 	
A7 Nissan Climatic endurance (For information)	36-05-019 /--G § 6.19	<p>➔ Relays Holders in configuration B</p> <ul style="list-style-type: none"> ▪ Holder not powered ▪ 120 Hrs at 120°C 	<ul style="list-style-type: none"> ▪ No visible deformation nor crack ▪ 	

OTHER TESTS				
	Test description	Ref. RSA For indication	Procedure	Requirement
O1	Speed of combustibility	36-05-219 /--C § 7.9.1	Test on standard material sample According test method D45 1333	Classe E Combustibility rate < 100mm/min
O2	Glow wire test	36-05-219 /--C § 7.9.2	→ Relays Holders in configuration C Test method D45 1730 with Wire temperature 750°C ± 10°C Duration of incandescent wire application is 30 s ± 1s	No presence of a flame shall be observed 30 seconds after the incandescent wire has been moved away.
O3	Resistance to fluids	36-05-019 /--G § 6.18	→ Relays Holders in configuration A The tests are performed in accordance with Test Method D47 1924. Test with the following fluids: Engine oil Battery electrolyte Mechanical gearbox oil Coolants Brake fluid Fuels "Severely cold" windscreen washing fluid	At the end of the test, the parts tested must meet the following test requirements: <ul style="list-style-type: none"> ▪ No deformation or cracks shall be observed. ▪ Voltage resistance. ▪ Terminal resistance variation, ΔRc,

6. QUALITY INSURANCE MEASURE

6.1. Qualification test

Samples must be in accordance with drawings and be taken in a random way in the production in progress.

6.2. Program approval tests
In the groups defined below, the boxes undergo all the tests in the chronological order of the figure

6.2.1. Renault Holders

SERIAL QUALIFICATION PLAN, RELAY HOLDERS

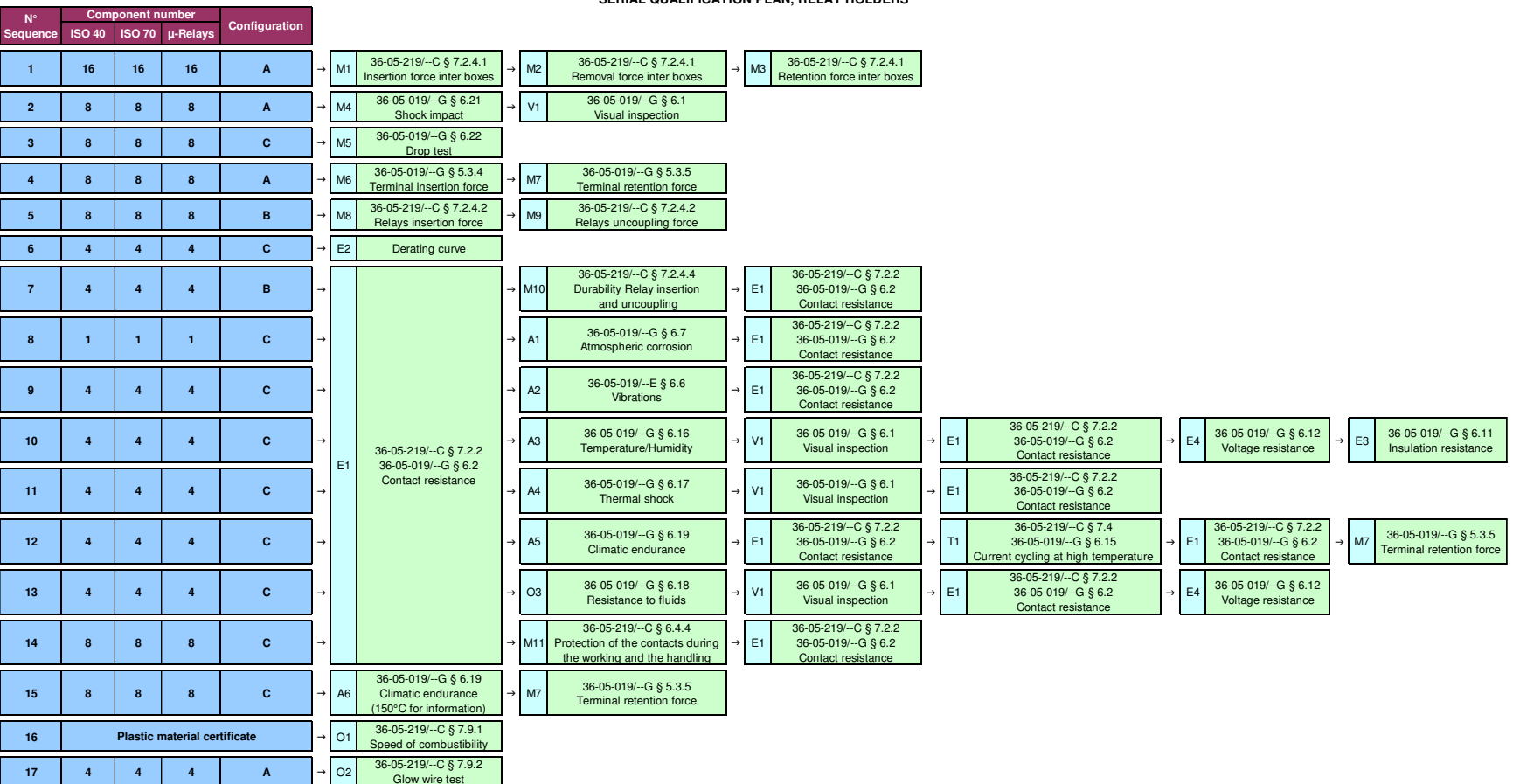



RELAYS HOLDERS Product Specification

108-15412

March 15th, 2019 – Rev. B

6.2.2. Nissan Holders

Design Verification Plan and Report										DVP Number	Dept#		
Component: Micro-Relais Holder										1802257-1	Engineering		
Model Year: Applications: FUSES AND RELAYS BOX CABIN										TE P/N: 1802257-1	Plan DD-Month-Date Year		
Sub-Assy: Assy										Originator: +33 (0)13 420 87 98	Plan: Isabelle CHARVET		
Customer P/N: Carlines										Manager: Imad SMIRANI	App'l: +33 (0)13420 83 79		
Source: TE Connectivity										Report Date	Reporting Engineer		
DD-Month-Year													
TEST PLAN										TEST REPORT			NOTES
Item N°	Procedure, Technical Regulation or Standard	Test Description	Acceptance Criteria	Target / Requirements	Sample		Duration	Timing (YYWW)		Samples Tested			
					Qty	Type (configuration)		Start	Compl	Qty	Type	Phase	
MECHANICAL TESTS													
Sequence 1													
1.1	36-05-219	M1: Insertion force interboxes	\$7.2.4.1	F < 60N	8	A							
1.2	36-05-219	M2: Removal force interboxes	\$7.2.4.1	F ≤ 60N	8	A							
1.3	36-05-219	M3: Retention force interboxes	\$7.2.4.1	F ≥ 100N	8	A							
Sequence 2													
2.1	36-05-019	M4: Shock impact	\$6.20	No break, cracking nor deformation	8	A							
2.2	36-05-019	V1: Visual inspection	\$6.1	Any failure spotted during examination must be identified	8	A							
Sequence 3													
3.1	36-05-019	M5: Drop test	\$6.21	No incipient rupture but uncealed damage permissible	12	A & C							
Sequence 4													
4.1	36-05-019	M6: Terminal insertion	\$5.3.4	Clip JPT 2,8 : ≤ 10N Clip SPT 4,8 : ≤ 15N	4	A							
4.2	36-05-019	M7: Terminal retention force	\$5.3.5	Clip JPT 2,8 : > 100N Clip SPT 4,8 : > 120N	4	A							
Sequence 5													
5.1	36-05-219	M8: Relays insertion force	\$7.2.4.2	F < 85N	8	B							
5.2	36-05-219	M9: Relays uncoupling force	\$7.2.4.2	30N < F < 115N	8	B							
5.3	36-05-219	M12: Relays retention force	\$7.2.4.2	F > 50N	8	B							
Sequence 6													
6.1	36-05-019	E1: Contact resistance	\$6.2	Initial contact resistance : > Micro Relay : ≤ 6mΩ > JPT 2,8 : ≤ 3mΩ > SPT 4,8 : ≤ 3mΩ After ageing tests : > Micro Relay ΔRc ≤ 6mΩ > JPT 2,8 : ΔRc ≤ 4mΩ > SPT 4,8 : ΔRc ≤ 3mΩ	3	C							
6.2	36-05-219	M10: Durability insertion and uncoupling components	\$7.2.4.4	> Component insertion force or/and the decrease must be lower than 10% of the 1st operation > Component removing force or/and the decrease must be lower than 10% of the 1st operation > Contact resistance maxi	3	B							
6.3	36-05-019	E1: Contact resistance	\$6.2	Initial contact resistance : > Micro Relay : ≤ 6mΩ > JPT 2,8 : ≤ 3mΩ > SPT 4,8 : ≤ 3mΩ After ageing tests : > Micro Relay ΔRc ≤ 6mΩ > JPT 2,8 : ΔRc ≤ 4mΩ > SPT 4,8 : ΔRc ≤ 3mΩ	3	C							
Sequence 7													
7.1	36-05-019	E1: Contact resistance	\$6.2	Initial contact resistance : > Micro Relay : ≤ 6mΩ > JPT 2,8 : ≤ 3mΩ > SPT 4,8 : ≤ 3mΩ After ageing tests : > Micro Relay ΔRc ≤ 6mΩ > JPT 2,8 : ΔRc ≤ 4mΩ > SPT 4,8 : ΔRc ≤ 3mΩ	3	C							
7.2	36-05-019 E	A2: Vibration	\$6.9	No breakdown above 1μs	3	C							
7.3	36-05-019	E1: Contact resistance	\$6.2	Initial contact resistance : > Micro Relay : ≤ 6mΩ > JPT 2,8 : ≤ 3mΩ > SPT 4,8 : ≤ 3mΩ After ageing tests : > Micro Relay ΔRc ≤ 6mΩ > JPT 2,8 : ΔRc ≤ 4mΩ > SPT 4,8 : ΔRc ≤ 3mΩ	3	C							
Sequence 8													
8.1	36-05-019 G	A7: Climatic endurance (for information) > Holder not powered > 120Hours at 120°C	\$6.19	No visible deformation nor cracks	10	B							
8.2	36-05-219	M9: relays uncoupling force	\$7.2.4.2	30N < F < 115N	10	B							

6.3. General conditions of test

Unless otherwise specified, the tests are conducted in the following conditions.
Minimum test samples quantity: 2 parts (1 by cavity)

6.4. Test and conformity

Conformity test is made regarding specific Tyco Electronics quality inspection plan which define acceptable quality limit based on number of samples.
Dimensional and functional requirement must meet production drawing and that specification.

APPENDIX 1 : Relays rating

Relay 40A Holder:



Relay 70A Holder:



2 Micro Relays Holder (Renault and Nissan version):

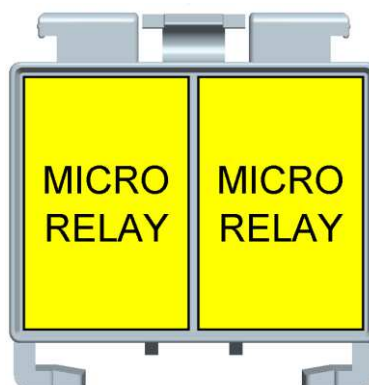

APPENDIX 2 : WIRING ARCHITECTURE

Relay 40A Holder:

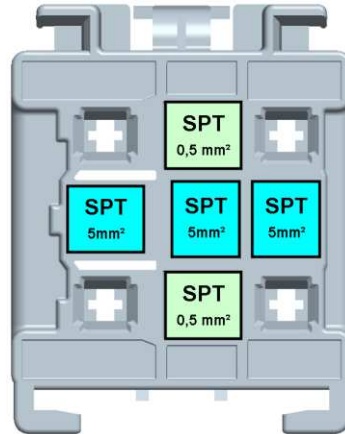

Relay 70A Holder:

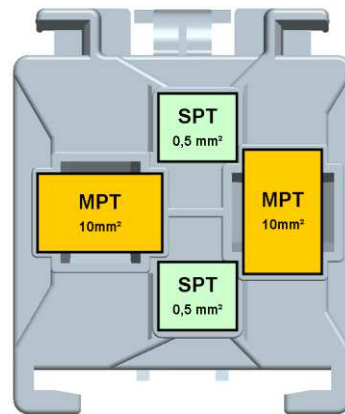

2 Micro Relays Holder (Renault and Nissan version):

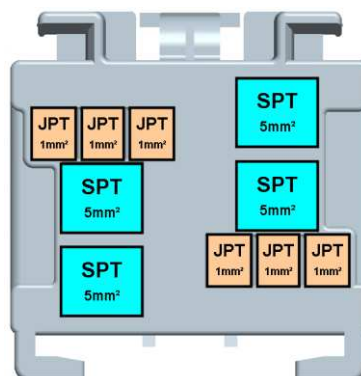

APPENDIX 3 : CURRENT LOAD SCENARIOS AT 85°C

Relay 40A Holder:



Relay 70A Holder:



2 Micro Relays Holder (Renault and Nissan version):

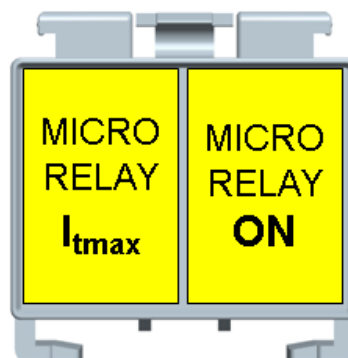

I_{tmax} is the current that heat up the contact zone at 125°C (given by the derating curve)

APPENDIX 4: VIBRATION PROFIL

- Temperature cycling during vibration endurance test:

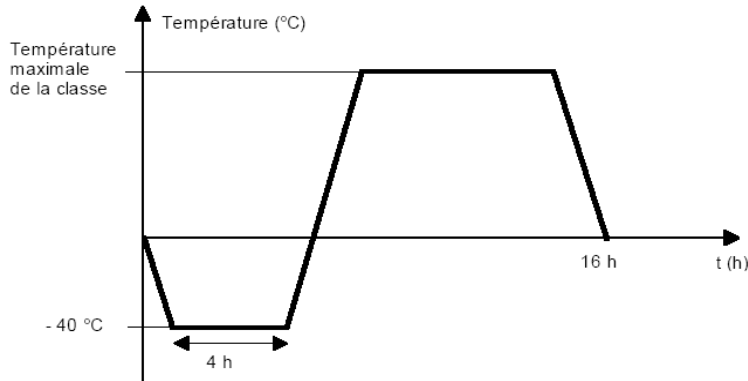

Tmin = -40°C
Tmax = +100°C
Temperature variation:
40°C/hour
Maintaining at extreme
temperature: 4h

- Vibration profile:

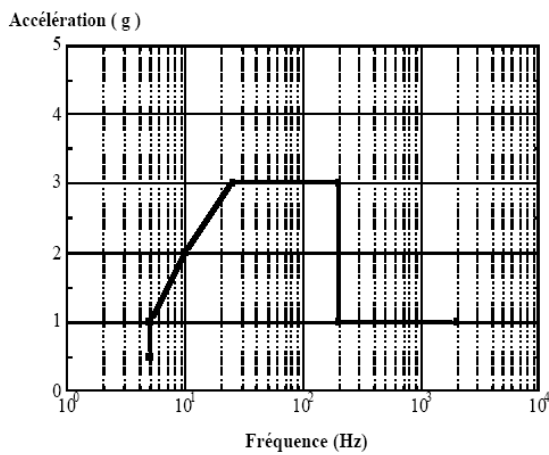

Fréquences	Accélération
5 Hz	0,5 g à 1 g
10 Hz	2 g
25 Hz à 200 Hz	3 g
200 Hz	3 g à 1g
200 Hz à 2000 Hz	1 g

APPENDIX 5: TEMPERATURE HUMIDITY CYCLE

Tmax = 125°C

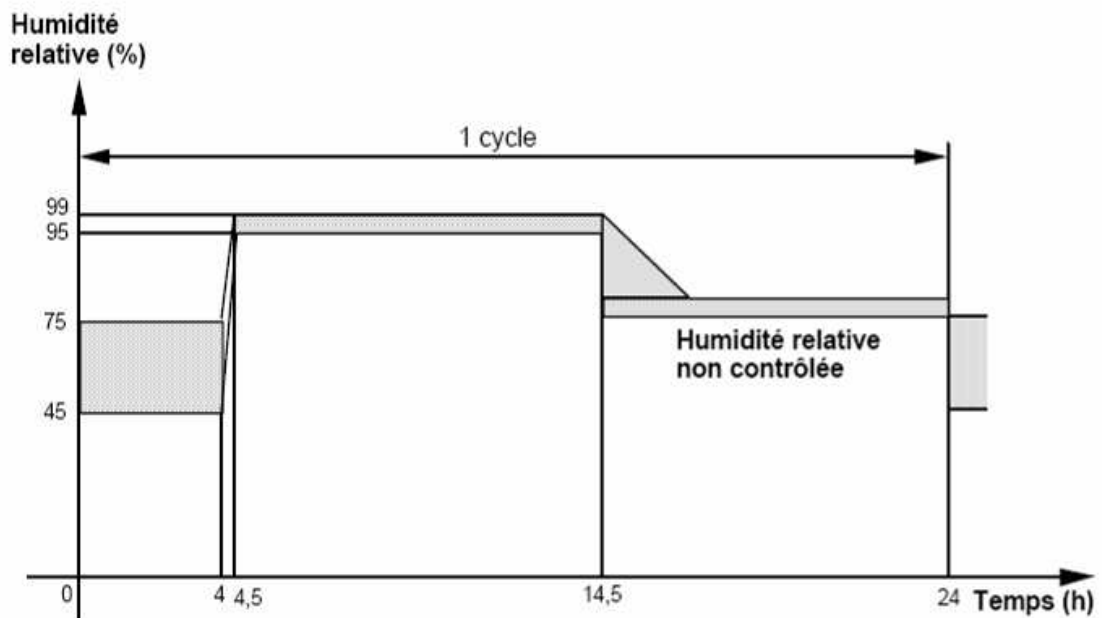
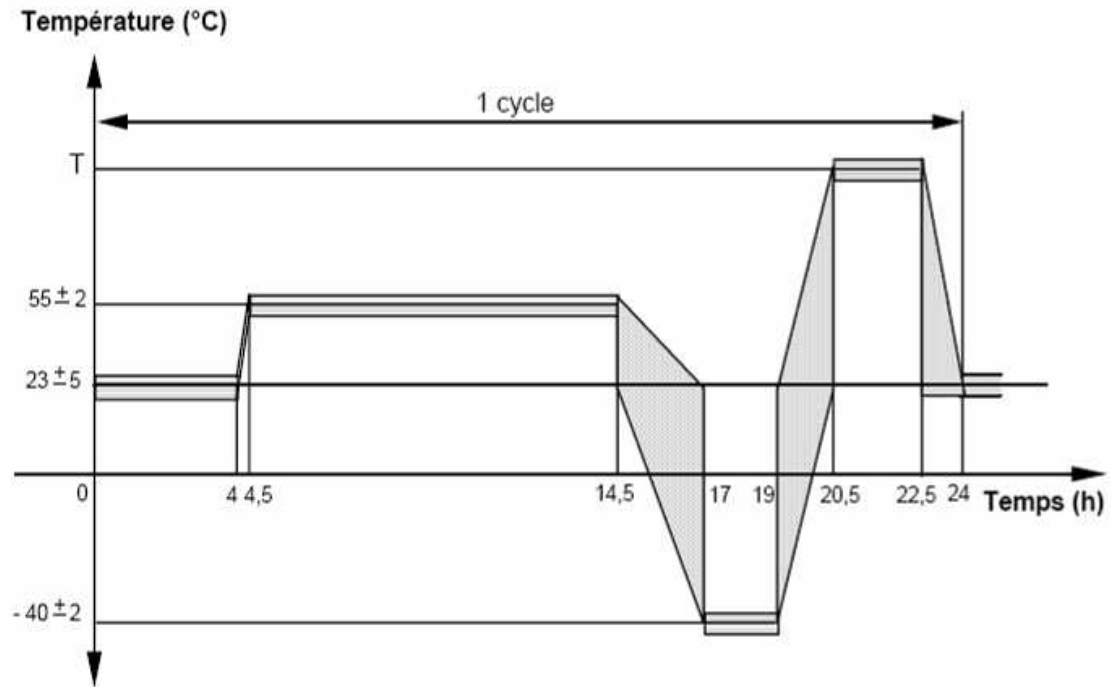

APPENDIX 6: TABLE OF TEST CONFIGURATION FOR INTER BOXES MECHANICAL TESTS

		Number of tested parts		
		Relay holder 20A micro-relais	Relay holder 40A	Relay holder 70A
Pièces ref	Relay holder 20A micro-relais	8		
			8	
				8
	Relay holder 40A	8		
			8	
				8
Relay holder 70A	8			
		8		
			8	

Table 1

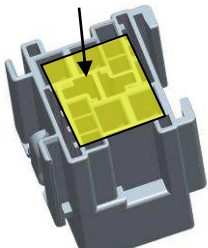
	Insertion test	Removal test Locking system inactive	Retention forces test	Area for shock impact test
Relay holder 20A micro-relais (Renault version)				
Relay holder 20A micro-relais (Nissan version)				

Table 2

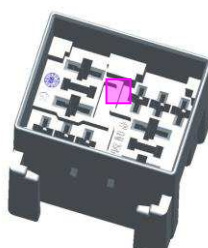
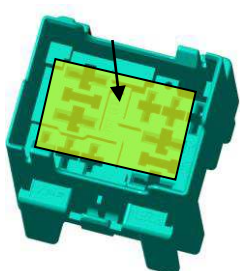
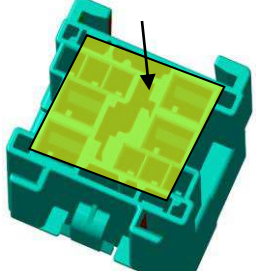
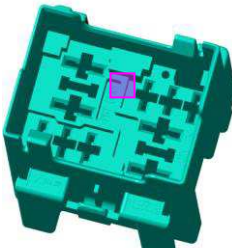
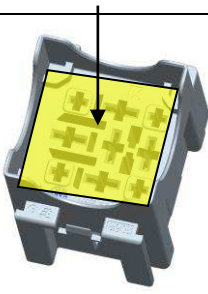
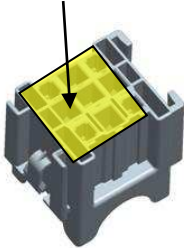
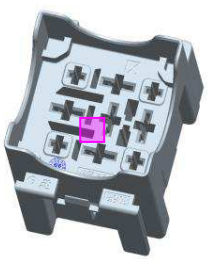
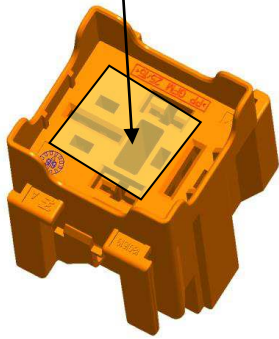

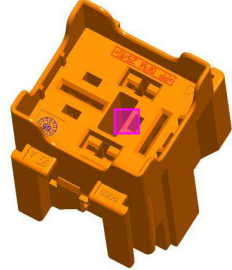
	Insertion test	Removal test Locking system inactive	Retention forces test	Area for shock impact test
Relay holder 40A				
Relay holder 70A				

Table 3