



ANT-5GW-SPNF1

Panel Mount Cellular Sub-6 5G Antenna

The 5GW-SPNF1 is a dipole, panel mount dome-style antenna for 5G New Radio, LTE, and cellular IoT (LTE-M, NB-IoT) applications. As a 5G NR antenna, the 5GW-SPNF1 performs in the 617 MHz to 960 MHz low band, and excels in the 2496 MHz to 2690 MHz and 3300 MHz to 5000 MHz ranges for CBRS private networking, 4.9 GHz public safety and emerging 2.5 GHz and C-band applications.

The 5GW-SPNF1 provides a ground plane independent dipole antenna solution which mounts permanently to metallic and non-metallic surfaces using the integrated N jack (female socket) connector while enabling an environmentally sealed enclosure and protection from tampering.

FEATURES

- Performance at 3.3 GHz to 3.8 GHz
 - VSWR: ≤ 4.1
 - Peak Gain: 6.5 dBi
 - Efficiency: 92%
- Ground plane independent dipole antenna
- N jack (female socket)
- External mount, includes all hardware for installation including 5/8"-24UNEF hex nut, washer and optional boot
- IP67 rated
- Impact resistant UV stabilized ABS radome material

APPLICATIONS

- Worldwide 5G/4G/3G/2G
- Cellular IoT: NB-IoT and LTE-M (Cat-M1)
- Private cellular networks
 - Citizens Broadband Radio Service (CBRS)
- 4.9 GHz Public Safety
- Emerging 5G C-Band applications
- Emerging 5G 2.5 GHz EBS applications
- Internet of Things (IoT) devices

ORDERING INFORMATION

Part Number	Description
ANT-5GW-SPNF1	Cellular 5G panel mount antenna with N jack (female socket)

Available from Linx Technologies and select distributors and representatives.

TABLE 1. ELECTRICAL SPECIFICATIONS

ANT-5GW-SPNF1	Frequency Range	VSWR (max.)	Peak Gain (dBi)	Avg. Gain (dBi)	Efficiency (%)
Band 71	617 MHz to 698 MHz	7.0	1.3	-3.1	56
Band 12, 13, 14, 17, 26, 28, 29	698 MHz to 803 MHz	3.0	3.3	-0.7	89
Band 5, 8, 20	791 MHz to 960 MHz	3.0	3.3	-0.6	92
Band 1, 2, 3, 4, 25, 66	1710 MHz to 2200 MHz	1.7	5.1	-0.7	89
Band 30, 40	2300 MHz to 2400 MHz	1.6	4.5	-0.3	96
Band 7, 41	2496 MHz to 2690 MHz	1.7	5.1	-0.4	96
Band 22, 42, 43, 48, 49, 52, n77, n78	3300 MHz to 3800 MHz	4.1	6.5	-0.5	92
CBRS	3550 MHz to 3700 MHz	4.1	6.5	-0.4	93
C-Band	3700 MHz to 4200 MHz	3.6	6.8	-0.5	94
Band n79	4400 MHz to 5000 MHz	1.8	8.4	-0.7	90

TABLE 2. MECHANICAL SPECIFICATIONS

Parameter	Value
Polarization	Linear
Radiation	Omnidirectional
Max Power	10 W
Wavelength	1/2-wave
Electrical Type	Dipole
Impedance	50 Ω
Connection	N jack (female socket)
Operating Temperature Range	-30 °C to +70 °C
Weight	63.9 g (2.25 oz)
IP Rating	IP67
Dimensions	70.8 mm x Ø40.2 mm (2.79 in x Ø1.58 in)

Electrical specifications and plots measured with a 300 mm x 300 mm (11.8 in x 11.8 in) ground plane.

PRODUCT DIMENSIONS

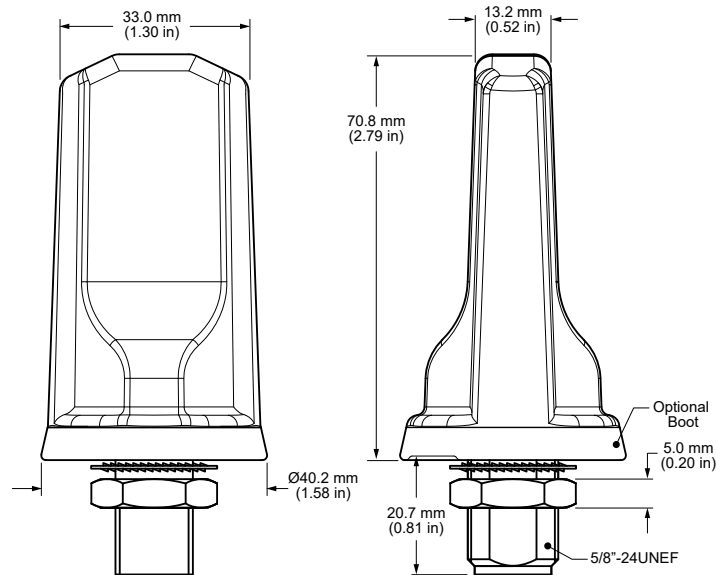

Figure 1: ANT-5GW-SPNF1 Antenna Dimensions

VSWR

Figure 2 provides the voltage standing wave ratio (VSWR) across the antenna bandwidth. VSWR describes the power reflected from the antenna back to the radio. A lower VSWR value indicates better antenna performance at a given frequency. Reflected power is also shown on the right-side vertical axis as a gauge of the percentage of transmitter power reflected back from the antenna.

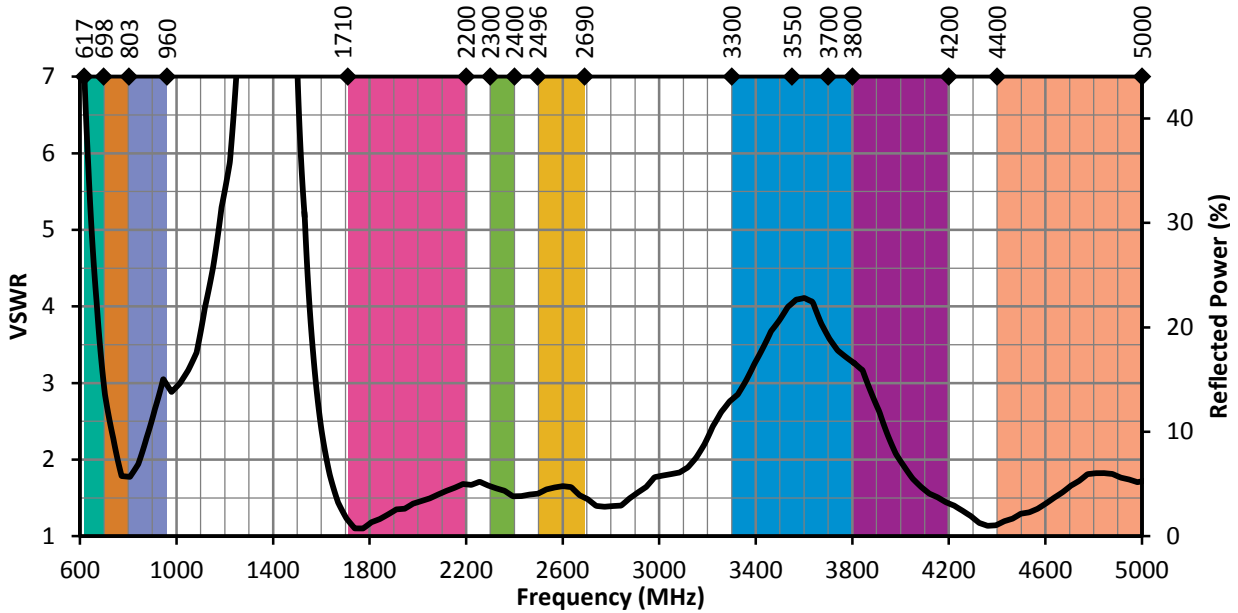

Figure 2. ANT-5GW-SPNF1 VSWR with Frequency Band Highlights

RETURN LOSS

Return loss (Figure 3), represents the loss in power at the antenna due to reflected signals. Like VSWR, a lower return loss value indicates better antenna performance at a given frequency.

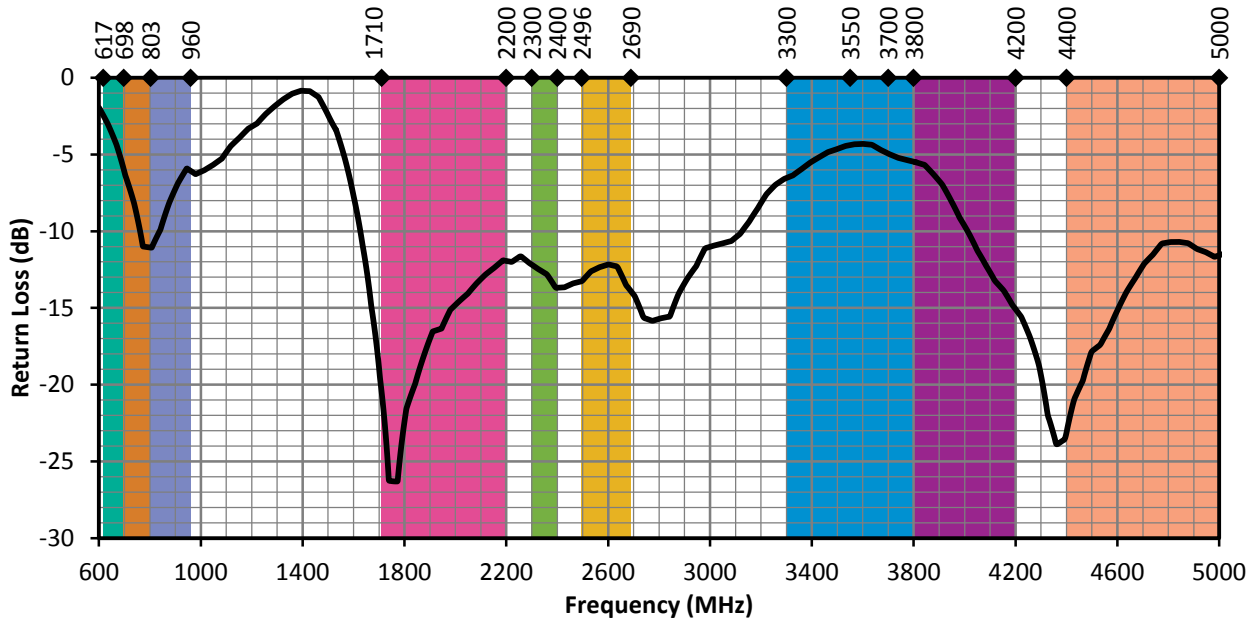

Figure 3. ANT-5GW-SPNF1 Return Loss with Frequency Band Highlights

PEAK GAIN

The peak gain across the antenna bandwidth is shown in Figure 4. Peak gain represents the maximum antenna input power concentration across 3-dimensional space, and therefore peak performance at a given frequency, but does not consider any directionality in the gain pattern.

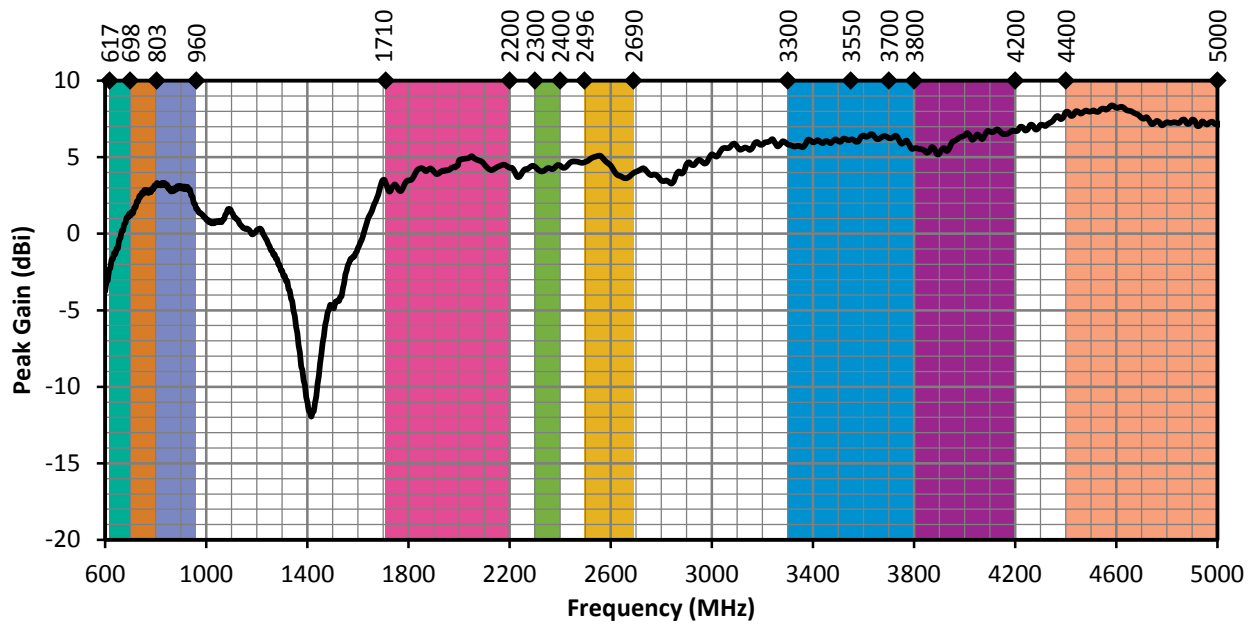

Figure 4 ANT-5GW-SPNF1 Peak Gain with Frequency Band Highlights

AVERAGE GAIN

Average gain (Figure 5), is the average of all antenna gain in 3-dimensional space at each frequency, providing an indication of overall performance without expressing antenna directionality.

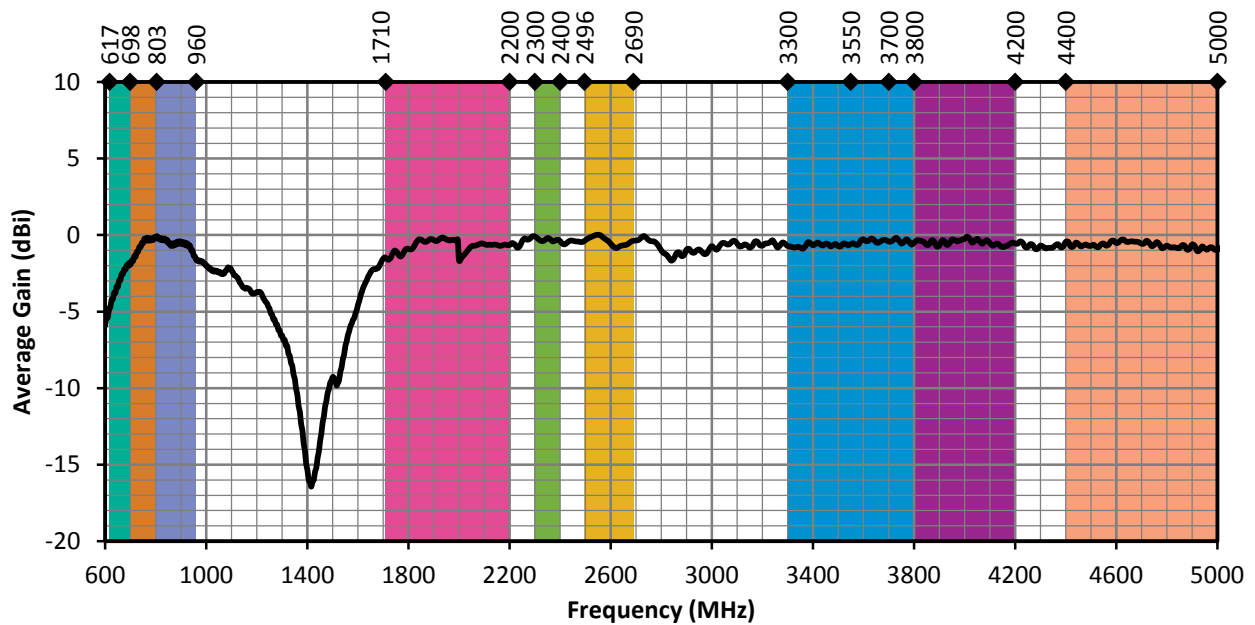

Figure 5. ANT-5GW-SPNF1 Antenna Average Gain with Frequency Band Highlights

RADIATION EFFICIENCY

Radiation efficiency (Figure 6), shows the ratio of power delivered to the antenna relative to the power radiated at the antenna, expressed as a percentage, where a higher percentage indicates better performance at a given frequency.

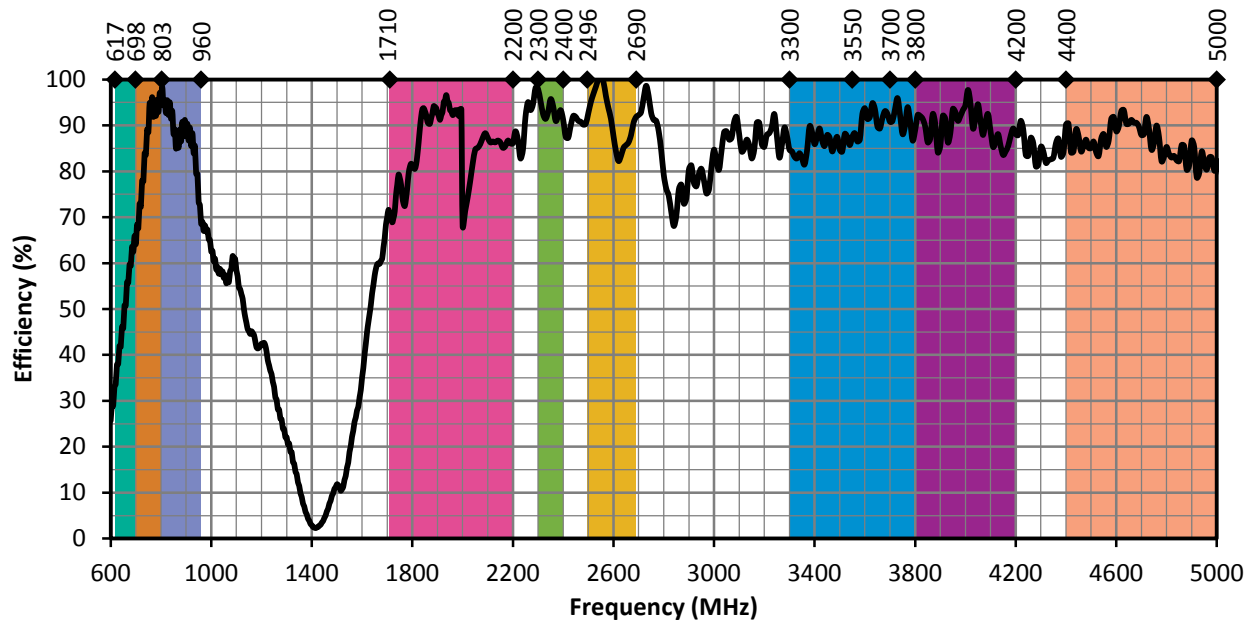

Figure 6. ANT-5GW-SPNF1 Antenna Efficiency with Frequency Band Highlights

RADIATION PATTERNS

Radiation patterns provide information about the directionality and 3-dimensional gain performance of the antenna by plotting gain at specific frequencies in three orthogonal planes. Antenna radiation patterns for an orientation at the center of the ground plane are shown in Figure 9 using polar plots covering 360 degrees. The antenna graphic at the top of the page provides reference to the plane of the column of plots below it. Note: when viewed with typical PDF viewing software, zooming into radiation patterns is possible to reveal fine detail.

RADIATION PATTERNS



XZ-Plane Gain



YZ-Plane Gain



XY-Plane Gain

617 MHz TO 698 MHz (660 MHz)

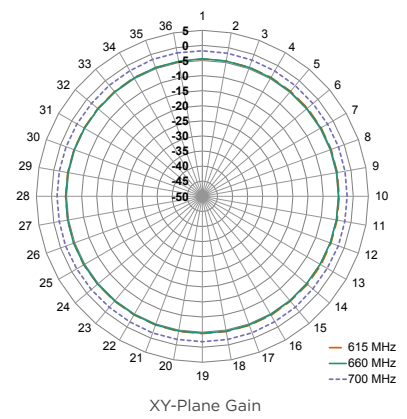
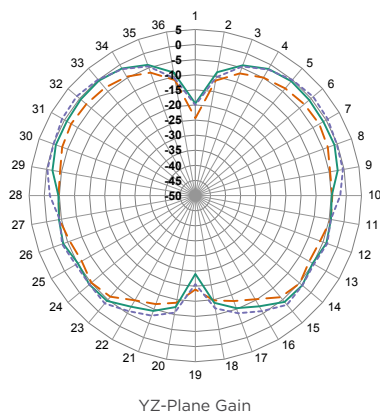
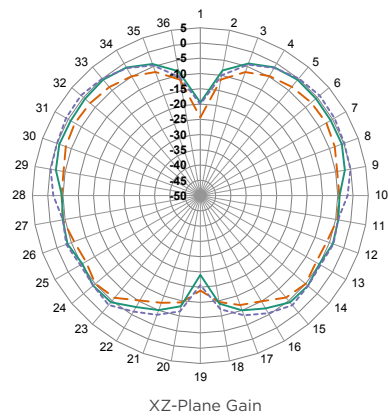

698 MHz TO 803 MHz (750 MHz)

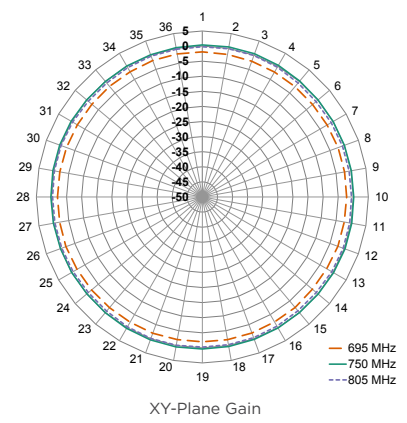
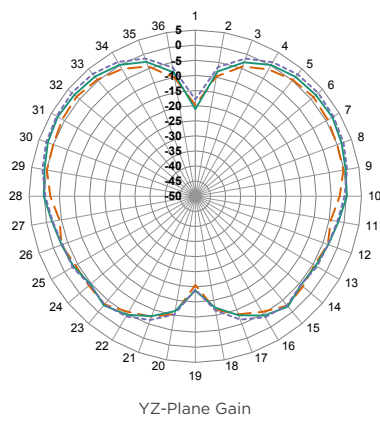
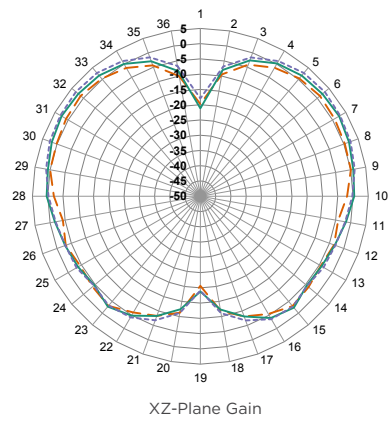

RADIATION PATTERNS

791 MHz TO 960 MHz (870 MHz)

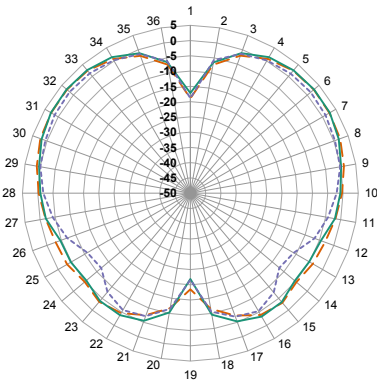

XZ-Plane Gain

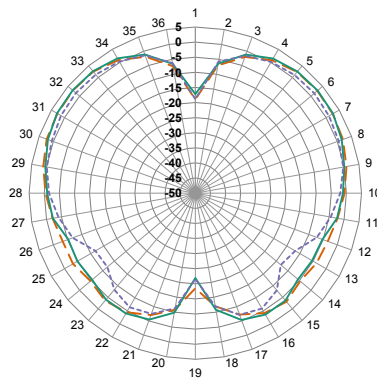

YZ-Plane Gain

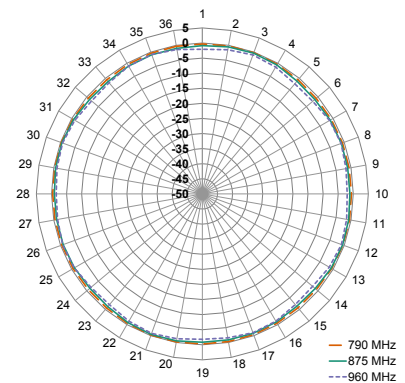

XY-Plane Gain

1710 MHz TO 2200 MHz (1950 MHz)

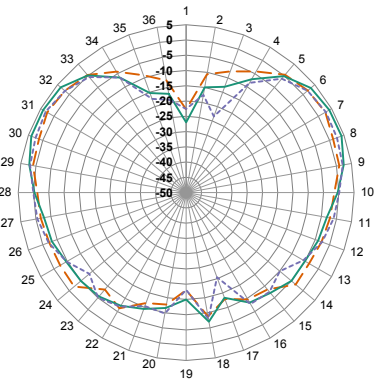

XZ-Plane Gain

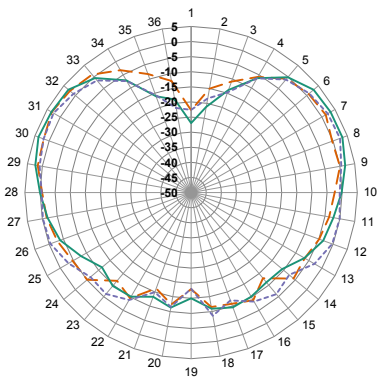

YZ-Plane Gain

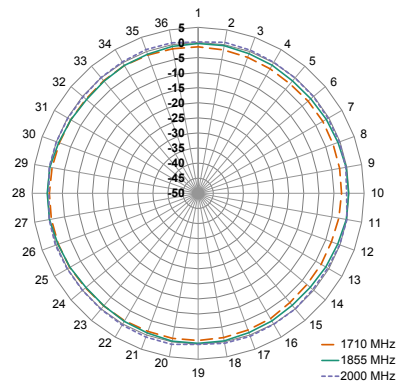

XY-Plane Gain

2300 MHz TO 2400 MHz (2350 MHz)

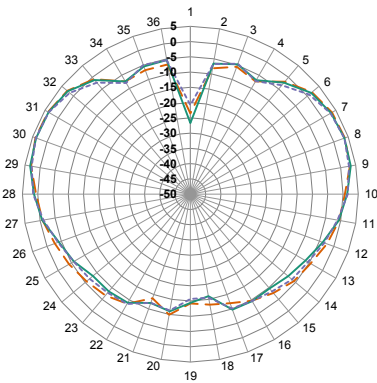

XZ-Plane Gain

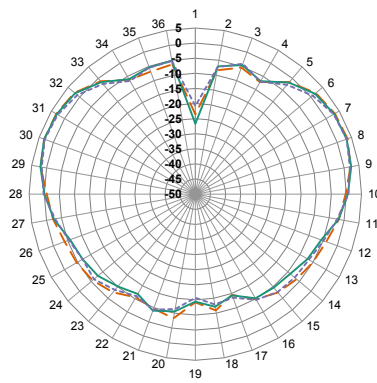

YZ-Plane Gain

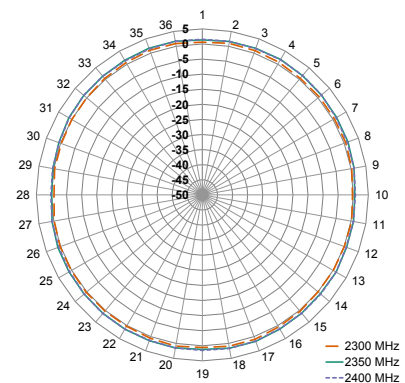

XY-Plane Gain

RADIATION PATTERNS - STRAIGHT

2496 MHz TO 2690 MHz (2600 MHz)

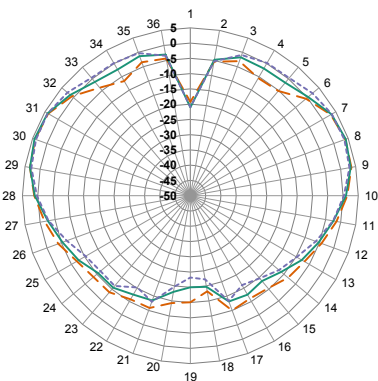

XZ-Plane Gain

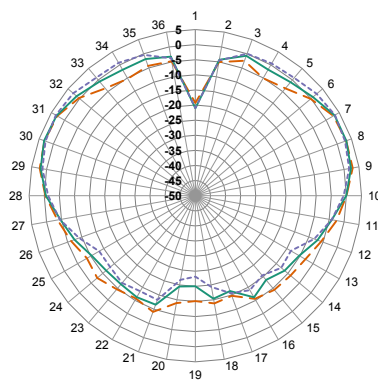

YZ-Plane Gain

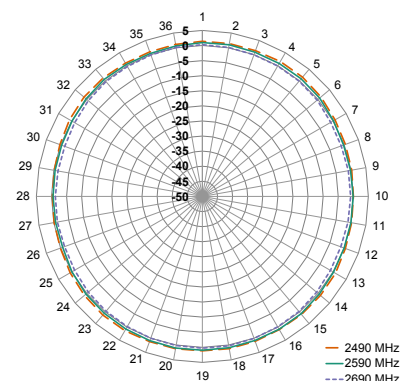

XY-Plane Gain

— 2490 MHz
— 2590 MHz
- - - 2690 MHz

3300 MHz TO 3800 MHz (3550 MHz)

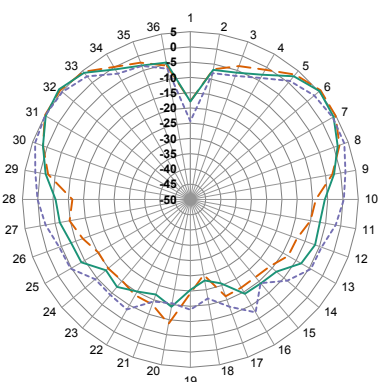

XZ-Plane Gain

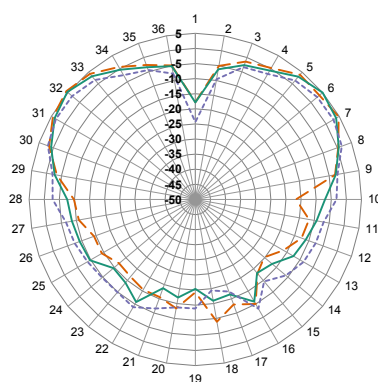

YZ-Plane Gain

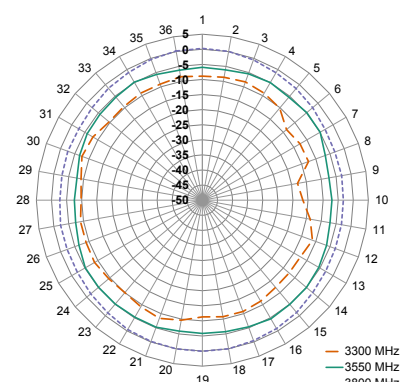

XY-Plane Gain

— 3300 MHz
— 3550 MHz
- - - 3800 MHz

3550 MHz TO 3700 MHz (3630 MHz)

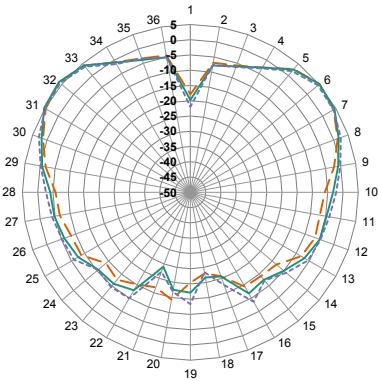

XZ-Plane Gain

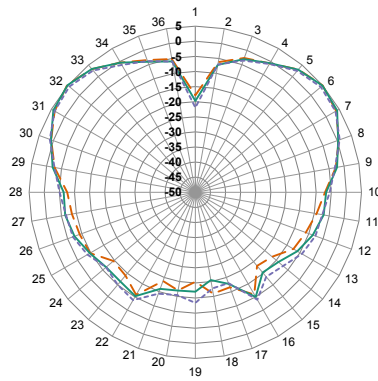

YZ-Plane Gain

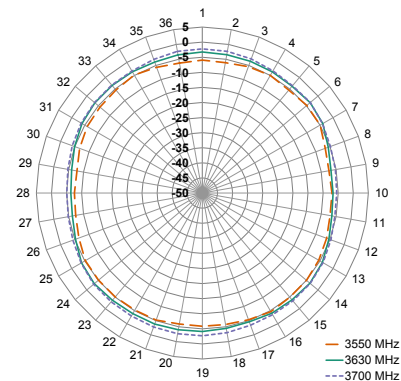

XY-Plane Gain

— 3550 MHz
— 3630 MHz
- - - 3700 MHz

RADIATION PATTERNS

3700 MHz TO 4200 MHz (3950 MHz)

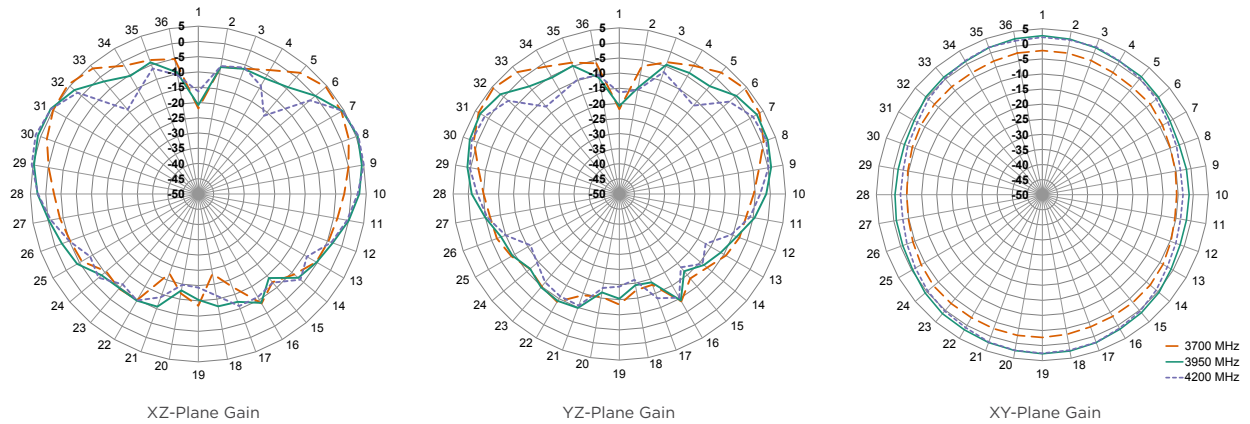

4400 MHz TO 5000 MHz (4700 MHz)

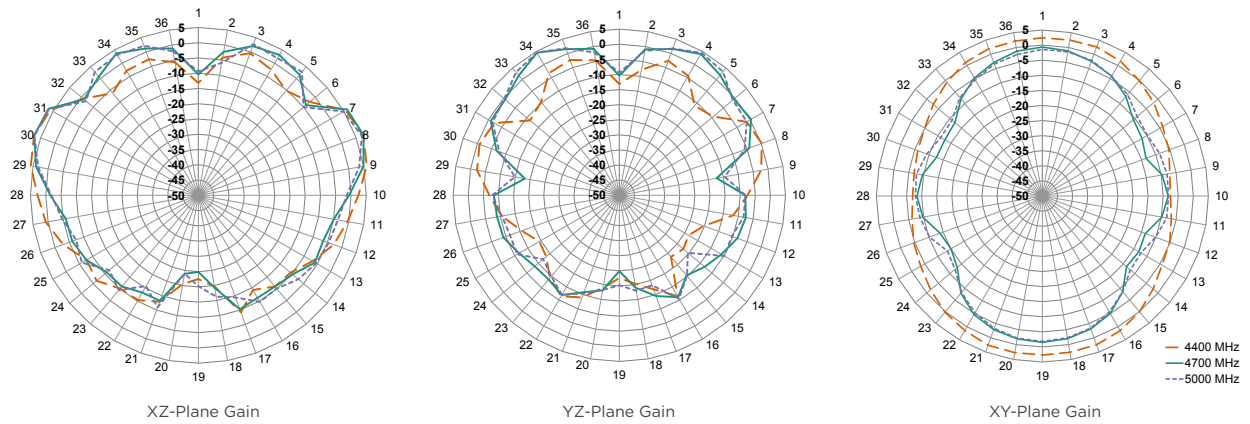

Figure 7. Radiation Patterns for ANT-5GW-SPNF1

ANTENNA MOUNTING

The ANT-5GW-SPNF1 antenna is an externally mounted multiband antenna that can be permanently installed onto metallic and non-metallic surfaces up to 3.16 mm (0.12 in) thick when used with the provided boot, and up to 4.0 mm (0.16 in) without the boot. Use of the boot is optional, and is intended to reduce the potential for marring of the mounting surface.

The antenna terminates in a 5/8"-24UNEF threaded N connector shaft which doubles as the mounting base and is provided with a washer and hex nut. The mounting hole dimensions are shown in Figure 8.

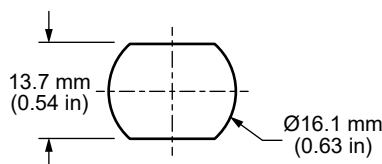

Figure 8. ANT-5GW-SPNF1 Mounting Hole Dimensions

PACKAGING INFORMATION

The ANT-5GW-SPNF1 antenna is individually placed in a polyethylene bag. 10 pcs. are sealed in larger polyethylene bags. Larger quantities are shipped in cartons of 60 pcs. Carton size = 320 mm x 250 mm x 230 mm (12.60 in x 9.84 in x 9.10 in). Distribution channels may offer alternative packaging options..

ANTENNA DEFINITIONS AND USEFUL FORMULAS

VSWR - Voltage Standing Wave Ratio. VSWR is a unitless ratio that describes the power reflected from the antenna back to the radio. A lower VSWR value indicates better antenna performance at a given frequency. VSWR is easily derived from Return Loss.

$$VSWR = \frac{10^{\left[\frac{\text{Return Loss}}{20}\right]} + 1}{10^{\left[\frac{\text{Return Loss}}{20}\right]} - 1}$$

Return Loss - Return loss represents the loss in power at the antenna due to reflected signals, measured in decibels. A lower return loss value indicates better antenna performance at a given frequency. Return Loss is easily derived from VSWR.

$$\text{Return Loss} = -20 \log_{10} \left[\frac{VSWR - 1}{VSWR + 1} \right]$$

Efficiency (η) - The total power radiated from an antenna divided by the input power at the feed point of the antenna as a percentage.

Total Radiated Efficiency - (TRE) The total efficiency of an antenna solution comprising the radiation efficiency of the antenna and the transmitted (forward) efficiency from the transmitter.

$$TRE = \eta \cdot \left(1 - \left(\frac{VSWR - 1}{VSWR + 1} \right)^2 \right)$$

Gain - The ratio of an antenna's efficiency in a given direction (G) to the power produced by a theoretical lossless (100% efficient) isotropic antenna. The gain of an antenna is almost always expressed in decibels.

$$G_{db} = 10 \log_{10}(G)$$

$$G_{dBd} = G_{dBi} - 2.51dB$$

Peak Gain - The highest antenna gain across all directions for a given frequency range. A directional antenna will have a very high peak gain compared to average gain.

Average Gain - The average gain across all directions for a given frequency range.

Maximum Power - The maximum signal power which may be applied to an antenna feed point, typically measured in watts (W).

Reflected Power - A portion of the forward power reflected back toward the amplifier due to a mismatch at the antenna port.

$$\left(\frac{VSWR - 1}{VSWR + 1} \right)^2$$

decibel (dB) - A logarithmic unit of measure of the power of an electrical signal.

decibel isotropic (dBi) - A comparative measure in decibels between an antenna under test and an isotropic radiator.

decibel relative to a dipole (dBd) - A comparative measure in decibels between an antenna under test and an ideal half-wave dipole.

Dipole - An ideal dipole comprises a straight electrical conductor measuring 1/2 wavelength from end to end connected at the center to a feed point for the radio.

Isotropic Radiator - A theoretical antenna which radiates energy equally in all directions as a perfect sphere.

Omnidirectional - Term describing an antenna radiation pattern that is uniform in all directions. An isotropic antenna is the theoretical perfect omnidirectional antenna. An ideal dipole antenna has a donut-shaped radiation pattern and other practical antenna implementations will have less perfect but generally omnidirectional radiation patterns which are typically plotted on three axes.

TE TECHNICAL SUPPORT CENTER

USA:	+1 (800) 522-6752
Canada:	+1 (905) 475-6222
Mexico:	+52 (0) 55-1106-0800
Latin/S. America:	+54 (0) 11-4733-2200
Germany:	+49 (0) 6251-133-1999
UK:	+44 (0) 800-267666
France:	+33 (0) 1-3420-8686
Netherlands:	+31 (0) 73-6246-999
China:	+86 (0) 400-820-6015

te.com

TE Connectivity, TE, TE connectivity (logo), Linx and Linx Technologies are trademarks owned or licensed by the TE Connectivity Ltd. family of companies. All other logos, products and/or company names referred to herein might be trademarks of their respective owners.

The information given herein, including drawings, illustrations and schematics which are intended for illustration purposes only, is believed to be reliable. However, TE Connectivity makes no warranties as to its accuracy or completeness and disclaims any liability in connection with its use. TE Connectivity's obligations shall only be as set forth in TE Connectivity's Standard Terms and Conditions of Sale for this product and in no case will TE Connectivity be liable for any incidental, indirect or consequential damages arising out of the sale, resale, use or misuse of the product. Users of TE Connectivity products should make their own evaluation to determine the suitability of each such product for the specific application.

TE Connectivity warrants to the original end user customer of its products that its products are free from defects in material and workmanship. Subject to conditions and limitations TE Connectivity will, at its option, either repair or replace any part of its products that prove defective because of improper workmanship or materials. This limited warranty is in force for the useful lifetime of the original end product into which the TE Connectivity product is installed. Useful lifetime of the original end product may vary but is not warranted to exceed one (1) year from the original date of the end product purchase.

©2022 TE Connectivity. All Rights Reserved.

09/22 Original