

LT Series Transceiver Module Data Guide

Wireless made simple[®]

Warning: Some customers may want Linx radio frequency (“RF”) products to control machinery or devices remotely, including machinery or devices that can cause death, bodily injuries, and/or property damage if improperly or inadvertently triggered, particularly in industrial settings or other applications implicating life-safety concerns (“Life and Property Safety Situations”).

NO OEM LINX REMOTE CONTROL OR FUNCTION MODULE SHOULD EVER BE USED IN LIFE AND PROPERTY SAFETY SITUATIONS. No OEM Linx Remote Control or Function Module should be modified for Life and Property Safety Situations. Such modification cannot provide sufficient safety and will void the product’s regulatory certification and warranty.

Customers may use our (non-Function) Modules, Antenna and Connectors as part of other systems in Life Safety Situations, but only with necessary and industry appropriate redundancies and in compliance with applicable safety standards, including without limitation, ANSI and NFPA standards. It is solely the responsibility of any Linx customer who uses one or more of these products to incorporate appropriate redundancies and safety standards for the Life and Property Safety Situation application.

Do not use this or any Linx product to trigger an action directly from the data line or RSSI lines without a protocol or encoder/decoder to validate the data. Without validation, any signal from another unrelated transmitter in the environment received by the module could inadvertently trigger the action.

All RF products are susceptible to RF interference that can prevent communication. RF products without frequency agility or hopping implemented are more subject to interference. This module does not have a frequency hopping protocol built in.

Do not use any Linx product over the limits in this data guide. Excessive voltage or extended operation at the maximum voltage could cause product failure. Exceeding the reflow temperature profile could cause product failure which is not immediately evident.

Do not make any physical or electrical modifications to any Linx product. This will void the warranty and regulatory and UL certifications and may cause product failure which is not immediately evident.

Table of Contents

1	Description
1	Features
1	Applications
2	Ordering Information
2	Absolute Maximum Ratings
3	Electrical Specifications
5	Typical Performance Graphs
9	PIN Assignments
9	Pin Descriptions
10	Module Description
10	Theory of Operation
12	Using LADJ
12	Using the RSSI Line
13	Using the PDN Line
13	ESD Concerns
14	Using the Data Line
15	Power Supply Requirements
16	Transferring Data
17	Typical Applications
18	Antenna Considerations
19	Helpful Application Notes from Linx
19	Protocol Guidelines
20	Interference Considerations
21	Pad Layout
21	Board Layout Guidelines
23	Microstrip Details
24	Production Guidelines
24	Hand Assembly
24	Automated Assembly

- 26 General Antenna Rules
- 28 Common Antenna Styles
- 30 Regulatory Considerations

LT Series Transceiver Module

Data Guide

Description

The LT Series transceiver is ideal for the bidirectional wireless transfer of serial data, control or command information in the favorable 260–470MHz band. The transceiver is capable of generating +10dBm into a 50-ohm load and achieves an outstanding typical sensitivity of –112dBm. Its advanced synthesized architecture delivers outstanding stability and frequency accuracy and minimizes the effects of antenna pulling. When paired, the transceivers form a reliable wireless link that is capable of transferring data at rates of up to 10,000bps over distances of up to 3,000 feet (1000m). Applications operating over shorter distances or at lower data rates will also benefit from increased link reliability and superior noise immunity. Housed in a tiny reflow-compatible SMD package, the transceiver requires no external RF components except an antenna, which greatly simplifies integration and lowers assembly costs.

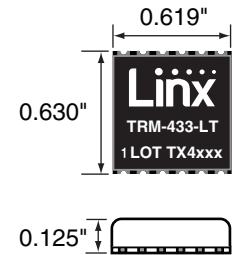

Figure 1: Package Dimensions

Features

- Long range
- Low cost
- PLL-synthesized architecture
- Direct serial interface
- Data rates up to 10,000bps
- No external RF components required
- Low power consumption
- Compact surface-mount package
- Wide temperature range
- RSSI and power-down functions
- No production tuning
- Easy to use

Applications

- 2-way remote control
- Keyless entry
- Garage/gate openers
- Lighting control
- Medical monitoring/call systems
- Remote industrial monitoring
- Periodic data transfer
- Home/industrial automation
- Fire/security alarms/access control
- Remote status/position sensing
- Long-range RFID
- Wire elimination

Ordering Information

Ordering Information	
Part Number	Description
TRM-315-LT	315MHz Transceiver
TRM-418-LT	418MHz Transceiver
TRM-433-LT	433MHz Transceiver
EVAL-***-LT	Basic Evaluation Kit

*** = 315, 418 (Standard), 433MHz
Transceivers are supplied in tubes of 18 pcs.

Figure 2: Ordering Information

Absolute Maximum Ratings

Absolute Maximum Ratings				
Supply Voltage V_{CC}	-0.3	to	+4.0	VDC
Any Input or Output Pin	-0.3	to	$V_{CC} + 0.3$	VDC
RF Input			0	dBm
Operating Temperature	-40	to	+85	°C
Storage Temperature	-65	to	+150	°C
Soldering Temperature	+260°C for 10 seconds			

Exceeding any of the limits of this section may lead to permanent damage to the device. Furthermore, extended operation at these maximum ratings may reduce the life of this device.

Figure 3: Absolute Maximum Ratings

 **Warning:** This product incorporates numerous static-sensitive components. Always wear an ESD wrist strap and observe proper ESD handling procedures when working with this device. Failure to observe this precaution may result in module damage or failure.

Electrical Specifications

LT Series Transceiver Specifications						
Parameter	Symbol	Min.	Typ.	Max.	Units	Notes
Power Supply						
Operating Voltage	V_{CC}	2.1	3.0	3.6	VDC	
Supply Current	I_{CC}					
TX Mode Logic High			12	14	mA	1
TX Mode Logic High			7.6	9.5	mA	2
TX Mode Logic Low			4.0	5.0	mA	
Receive Mode			6.1	7.9	mA	
Power Down Current	I_{PDN}		11.5	20.0	µA	9,10
DATA Line						
Output Low Voltage	V_{OL}		0.15		VDC	3
Output High Voltage	V_{OH}		$V_{CC} - 0.26$		VDC	4
Input Low Threshold	V_{IL}			$0.1 V_{CC}$	VDC	5
Input High Threshold	V_{IH}	$0.9 V_{CC}$			VDC	
Power Down Input						
Input Low Threshold	V_{IL}			$0.1 V_{CC}$	VDC	5
Input High Threshold	V_{IH}	$0.9 V_{CC}$			VDC	
RF Section						
Frequency Range	F_C					
TRM-315-LT			315		MHz	
TRM-418-LT			418		MHz	
TRM-433-LT			433.92		MHz	
Center Frequency Accuracy		-50		+50	kHz	
Data Rate		65		10,000	bps	
Receiver Section						
LO Feedthrough			-80		dBm	6,9
IF Frequency	F_{IF}		10.7		MHz	9
Noise Bandwidth	N_{3DB}		280		kHz	9
Receiver Sensitivity		-108	-112	-118	dBm	7
RSSI / Analog						
Dynamic Range			80		dB	9
Analog Bandwidth		20		5,000	Hz	9
Gain			15		mV/dB	9
Voltage with No Carrier			430		mV	9

LT Series Transceiver Specifications Continued

Parameter	Symbol	Min.	Typ.	Max.	Units	Notes
Transmitter Section						
Output Power	P_O		+9.2	+11	dBm	1,6
With a 750 Ω resistor on LADJ	P_O	-4	0.0	4	dBm	2,6
Output Power Control Range		-30		MAX	dB	9
Harmonic Emissions	P_H			-36	dBc	6
Antenna Port						
RF Input Impedance	R_{IN}		50		Ω	9
Timing						
Receiver Turn-On Time						
Via V_{CC}			2.2		ms	8,9
Via PDN			0.25		ms	8,9
Max. Time Between Transitions			15.0		ms	9
Transmitter Turn-On Time						
Via V_{CC}			2.0		ms	9
Via PDN				500	μ s	9
Modulation Delay				30.0	ns	9
Transmit to Receive Switch Time			180	400	μ s	9
Receive to Transmit Switch Time			490	1000	μ s	9
Dwell Time		290			μ s	9,11
Environmental						
Operating Temperature Range		-40		+85	$^{\circ}$ C	9
1. With a 0 Ω resistor on LADJ			7. With a 50% square wave at 1,000bps			
2. With a 750 Ω resistor on LADJ			8. Time to valid data output			
3. $I_{SINK} = 500\mu$ A			9. Characterized, but not tested			
4. $I_{SOURCE} = 500\mu$ A			10. Receive Mode on power down (see Using the PDN Line section)			
5. $I_{SINK} = 20\mu$ A			11. Minimum time before mode change			
6. Into a 50 Ω load						

Figure 4: Electrical Specifications

Typical Performance Graphs

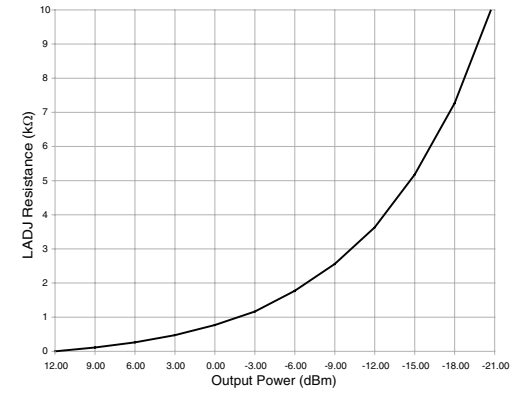

Figure 5: Output Power vs. LADJ Resistance

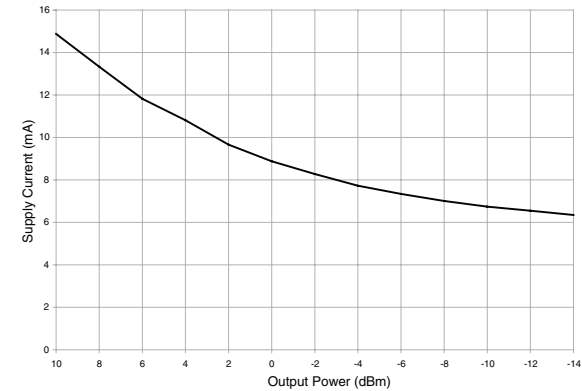

Figure 6: Output Power vs. Current Consumption

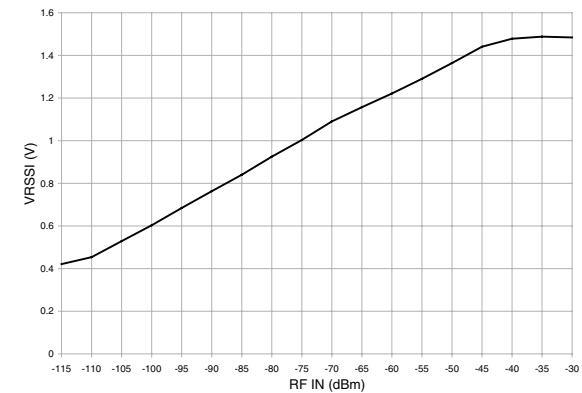

Figure 7: RSSI Curve

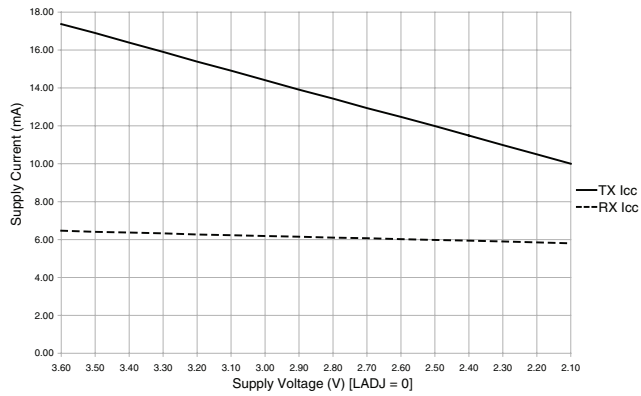

Figure 8: Current Consumption vs. Supply

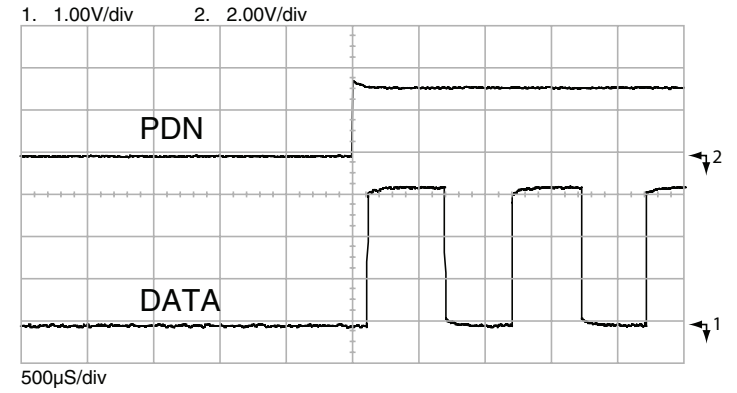

Figure 11: RX Turn-On Time from PDN

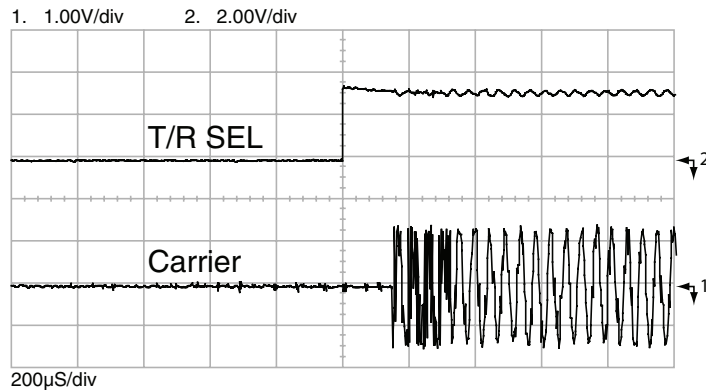

Figure 9: RX to TX Change Time

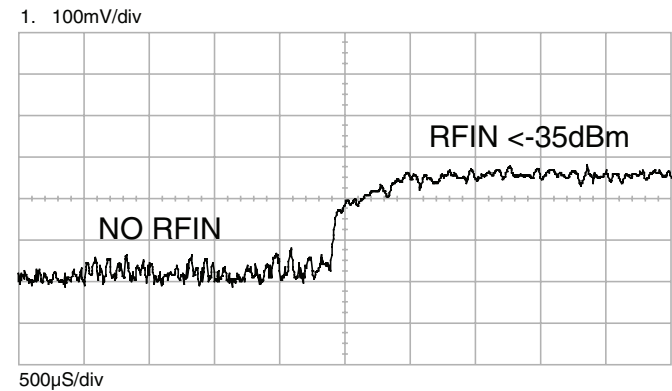

Figure 12: RSSI Response Time

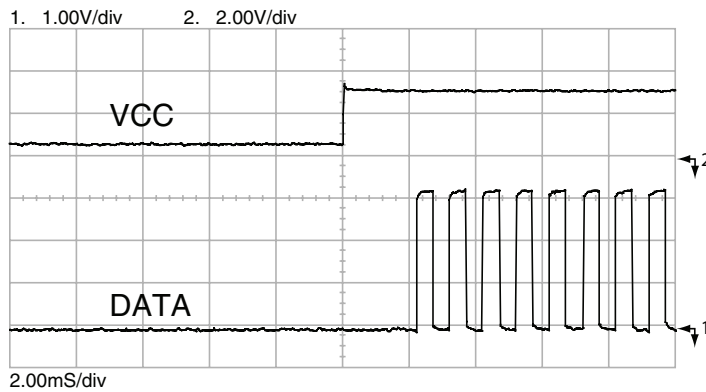

Figure 10: TX to RX Change Time

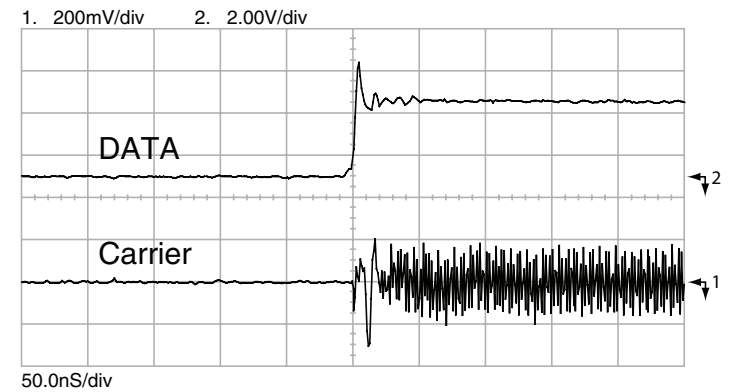

Figure 13: TX Modulation Delay

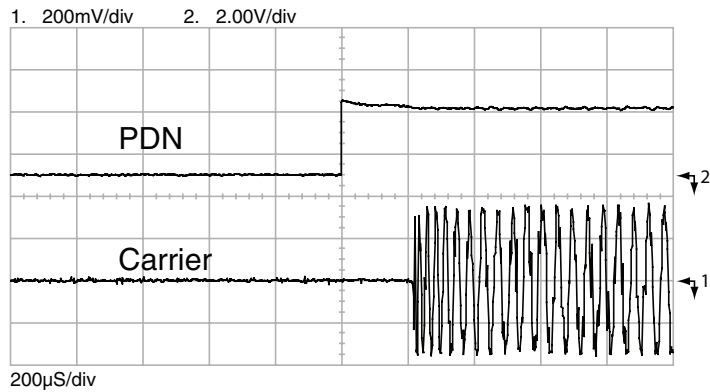

Figure 14: TX Turn-On Time from PDN

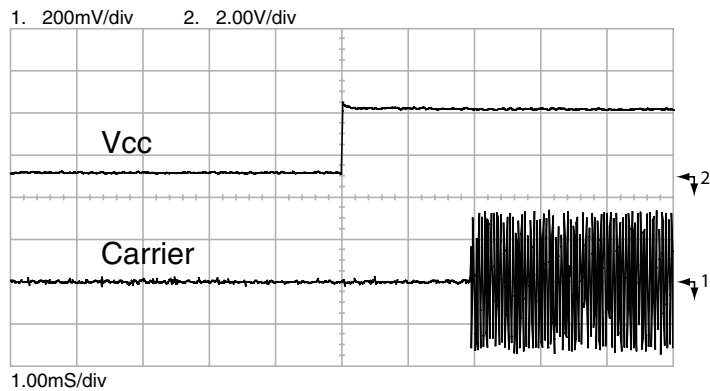

Figure 15: TX Turn-On Time from V_{cc}

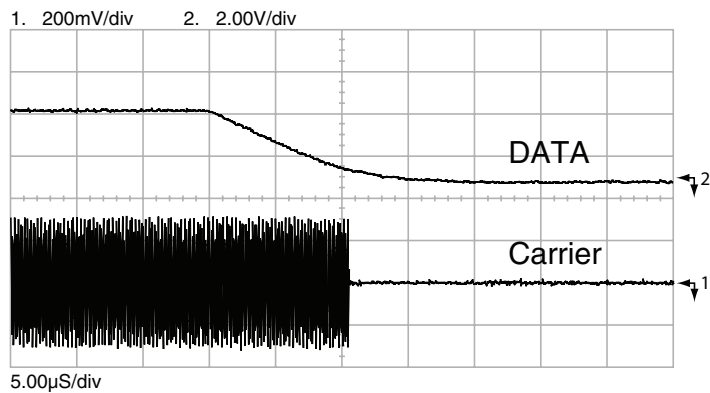

Figure 16: TX Turn-Off Time

Pin Assignments

1	ANT	LADJ	12
2	GND	VCC	11
3	NC	GND	10
4	RSSI	PDN	9
5	A REF	T/ \bar{R} SEL	8
6	ANALOG	DATA	7

Figure 17: LT Series Transceiver Pinout (Top View)

Pin Descriptions

Pin Descriptions			
Pin Number	Name	I/O	Description
1	ANT	—	50 Ω RF Port
2	GND	—	Analog Ground
3	NC	—	No Connection
4	RSSI	O	Received Signal Strength Indicator. This line will supply an analog voltage proportional to the received signal strength.
5	A REF	O	Analog RMS (Average) Voltage Reference
6	ANALOG	O	Recovered Analog Output
7	DATA	I/O	Digital Data Line. This line outputs the received data when in Receive Mode and is the data input when in Transmit Mode.
8	T/ \bar{R} _SEL	I	Transmit/Receive Select. Pull this line low to place the transceiver into receive mode. Pull high to place into transmit mode.
9	PDN	I	Power Down. Pull this line low or leave floating to place the receiver into a low-current state. The module is not be able to send or receive a signal in this state. Pull high to activate the transceiver.
10	GND	—	Analog Ground
11	V_{cc}	—	Supply Voltage
12	LADJ/ V_{cc}	I	Level Adjust. This line is used to adjust the output power level of the transmitter. Connecting to V_{cc} gives the highest output, while placing a resistor to V_{cc} lowers the output level (see Figure 5).

Figure 18: LT Series Transceiver Pin Descriptions

Module Description

The LT Series transceiver is a low-cost, high-performance synthesized AM OOK transceiver capable of transmitting and receiving serial data at up to 10,000bps over line-of-site distances of up to 3,000 feet (1000m). Its exceptional receiver sensitivity and highly stable transmitter output result in outstanding range performance. The transceiver is completely self-contained and does not require any additional RF components except an antenna. This greatly simplifies the design process, reduces time to market, and reduces production assembly and testing costs. The LT is housed in a compact surface-mount package that integrates easily into existing designs and is equally friendly to prototyping and volume production. The module's low power consumption makes it ideal for battery-powered products.

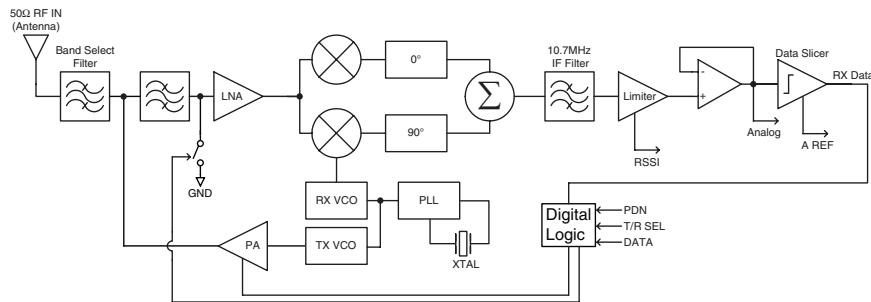

Figure 19: LT Series Transceiver Block Diagram

Theory of Operation

The LT Series transceiver sends and recovers data by AM or Carrier-Present Carrier-Absent (CPCA) modulation, also referred to as On-Off Keying (OOK). This type of modulation represents a logic low '0' by the absence of a carrier and a logic high '1' by the presence of a carrier (Figure 20). This method affords numerous benefits. The two most important are: 1) cost-effectiveness due to design simplicity and 2) higher legally-allowable output power and thus greater range in countries (such as the US) that average output power measurements over time.

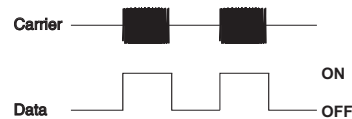

Figure 20: CPCA (AM) Modulation

filtered and then amplified by an NMOS cascode Low Noise Amplifier (LNA). The signal is then down-converted to a 10.7MHz Intermediate Frequency (IF) by mixing it with a low-side Local Oscillator (LO). The LO frequency is generated by a Voltage Controlled Oscillator (VCO) which is locked by a Phase-Locked Loop (PLL) frequency synthesizer referenced to a precision crystal. The mixer stage is a pair of double-balanced mixers and a unique image rejection circuit, which greatly reduces susceptibility to interference. The IF frequency is further amplified, filtered, and demodulated to recover the original signal. The signal is squared by a data slicer and output on the DATA line.

The LT's transmitter chain is designed to generate up to 10mW of output power into a 50-ohm single-ended antenna while suppressing harmonics and spurious emissions. The transmitter is comprised of a VCO locked by the PLL. The output of the VCO is amplified and buffered by a power amplifier. The amplifier is switched by the incoming data to produce a modulated carrier. The internal digital logic controls a switch that connects the LNA input to ground when in transmit mode, preventing the transmitter from de-sensitizing the receiver. The carrier is filtered to attenuate harmonics, and then output on the 50-ohm RF port.

The transceiver's topology makes the module highly immune to frequency pulling, mismatch, temperature, and other negative effects common to some low-cost architectures. The LT Series design and component quality enable it to outperform many far more expensive transceiver products, making it well-suited for a wide range of consumer and industrial applications.

Using LADJ

The Level Adjust (LADJ) line allows the transceiver's output power to be easily adjusted for range control, lower power consumption, or to meet legal requirements. This is done by placing a resistor between V_{CC} and LADJ. The value of the resistor determines the output power level. When LADJ is connected to V_{CC} , the output power and current consumption are the highest. Figure 5 shows a graph of the output power vs. LADJ resistance.

This line is very useful during FCC testing to compensate for antenna gain or other product-specific issues that may cause the output power to exceed legal limits. A variable resistor can be temporarily used so that the test lab can precisely adjust the output power to the maximum level allowed by law. The variable resistor's value can be noted and a fixed resistor substituted for final testing. Even in designs where attenuation is not anticipated, it is a good idea to place a resistor pad connected to LADJ and V_{CC} so that it can be used if needed. For more sophisticated designs, LADJ can also be controlled by a digital potentiometer to allow precise and digitally-variable output power control.

Using the RSSI Line

The transceiver's Received Signal Strength Indicator (RSSI) line serves a variety of functions. This line has a dynamic range of 80dB (typical) and outputs a voltage proportional to the incoming signal strength. The RSSI levels and dynamic range vary slightly from part to part. It is important to remember that the RSSI output indicates the strength of any in-band RF energy and not necessarily just that from the intended transmitter; therefore, it should be used only to qualify the level and presence of a signal. Using RSSI to determine distance or data validity is not recommended.

The RSSI output can be utilized during testing, or even as a product feature, to assess interference and channel quality by looking at the RSSI level with all intended transmitters shut off. RSSI can also be used in direction-finding applications, although there are many potential perils to consider in such systems. Finally, it can be used to save system power by "waking up" external circuitry when a transmission is received or crosses a certain threshold. The RSSI output feature adds tremendous versatility for the creative designer.

Using the PDN Line

The Power Down (PDN) line can be used to power down the transceiver without the need for an external switch. This line has an internal pull-down, so when it is held low or simply left floating, the module is inactive.

When the PDN line is pulled to ground, the transceiver enters into a low-current ($\sim 20\mu A$) power-down mode. During this time the transceiver is off and cannot perform any function. It may be useful to note that the startup time from power-down is slightly less than when applying V_{CC} .

The PDN line allows easy control of the receiver state from external components, such as a microcontroller. By periodically activating the transceiver, sending data, then powering down, the transceiver's average current consumption can be greatly reduced, saving power in battery-operated applications.

Note: If the T/\bar{R}_{SEL} line is toggled when the transceiver is powered down, internal logic wakes up and increases the current consumption to approximately $350\mu A$. When high, the T/\bar{R}_{SEL} line sinks approximately $15\mu A$, so the lowest current consumption is obtained by placing the LT into receive mode before powering down.

ESD Concerns

The module has basic ESD protection built in, but in cases where the antenna connection is exposed to the user it is a good idea to add additional protection. A Transient Voltage Suppressor (TVS) diode, varistor or similar component can be added to the antenna line. These should have low capacitance and be designed for use on antennas. Protection on the supply line is a good idea in designs that have a user-accessible power port.

Using the Data Line

The CMOS-compatible DATA line is used for both the transmitter data and the recovered receiver data. Its function is controlled by the state of the T/\bar{R} _SEL line, so it is an input when in transmit mode and an output when in receive mode. The output is normally connected to a transcoder IC or a microprocessor for data encoding and decoding.

It is important to note that the transceiver does not provide hysteresis or squelching of the DATA line when in receive mode. This means that, in the absence of a valid transmission or transitional data, the DATA line switches randomly. This noise can be handled in software by implementing a noise-tolerant protocol as described in Linx Application Note AN-00160. If a software solution is not appropriate, then the transceiver can be squelched.

Squelching disables the DATA output when the RSSI voltage falls below a reference level. This prevents low amplitude noise from causing the DATA line to switch, reducing hash during times that the transmitter is off or during transmitter steady-state times which exceed 15ms.

The voltage on the A REF line is the analog reference voltage that is used by the transceiver's data circuit. The received signal must be higher than this voltage for the DATA line to activate and must then fall lower than this output for the DATA line to deactivate. This voltage dynamically follows the midpoint of the received signal's voltage. There is always about 30mVp-p noise riding on the signal's voltage. During times with no carrier or during transmitter steady-state times exceeding 15mS, the reference voltage reaches a point where the noise causes the output to switch randomly.

To squelch the DATA line, an offset can be added to the A REF line by connecting a resistor to V_{CC} . This offset keeps the reference voltage above the noise, and quiets the DATA line. Typical resistor values are between 1M-ohm and 10M-ohm.

Squelching the output reduces the sensitivity of the receiver and therefore the range of the system. For this reason, the squelch threshold is normally set as low as possible, but the designer can make the compromise between noise level on the DATA line and range of the system. Figure 21 shows a graph of the sensitivity vs. the squelch resistor. Note that squelching causes some bit stretching and contracting, which could affect PWM-based protocols.

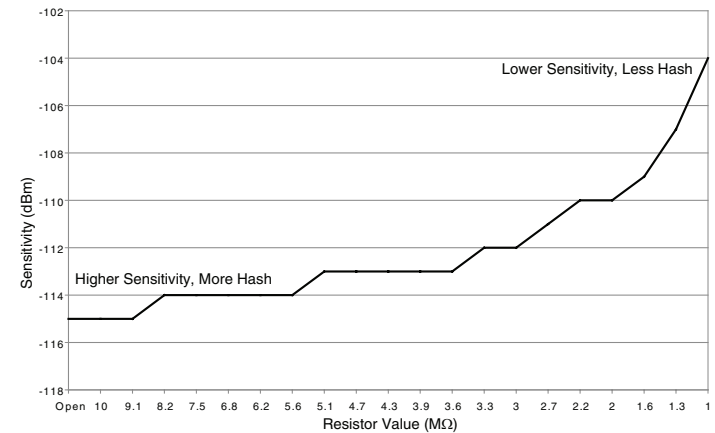

Figure 21: Sensitivity Degradation vs. Squelch Resistor

It is important to recognize that in many actual use environments, ambient noise and interference may enter the receiver at levels well above the squelch threshold. For this reason, it is always recommended that the product's protocol be structured to allow for the possibility of hashing, even when an external squelch circuit is employed.

Power Supply Requirements

The module does not have an internal voltage regulator; therefore it requires a clean, well-regulated power source. While it is preferable to power the unit from a battery, it can also be operated from a power supply as long as noise is less than 20mV. Power supply noise can affect the transmitter modulation; therefore, providing a clean power supply for the module should be a high priority during design.

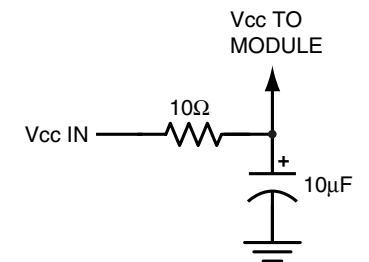

Figure 22: Supply Filter

A 10Ω resistor in series with the supply followed by a 10μF tantalum capacitor from V_{CC} to ground will help in cases where the quality of the supply is poor. Note that the values may need to be adjusted depending on the noise present on the supply line.

Transferring Data

Once a reliable RF link has been established, the challenge becomes how to effectively transfer data across it. While a properly designed RF link provides reliable data transfer under most conditions, there are still distinct differences from a wired link that must be addressed. The LT Series is intended to be as transparent as possible and does not incorporate internal encoding or decoding, so a user has tremendous flexibility in how data is handled.

If the product transfers simple control or status signals such as button presses or switch closures and it does not have a microprocessor on board (or it is desired to avoid protocol development), consider using a remote control encoder and decoder or a transcoder IC. These chips are available from a wide range of manufacturers including Linx. They take care of all encoding and decoding functions, and generally provide a number of data pins to which switches can be directly connected. In addition, address bits are usually provided for security and to allow the addressing of multiple units independently. These ICs are an excellent way to bring basic remote control / status products to market quickly and inexpensively. Additionally, it is a simple task to interface with inexpensive microprocessors, IR, remote control or modem ICs.

It is always important to separate the types of transmissions that are technically possible from those that are legally allowable in the country of intended operation. Linx Application Notes AN-00125, AN-00128 and AN-00140 should be reviewed, along with Part 15, Section 231 of the Code of Federal Regulations for further details regarding acceptable transmission content in the US. All of these documents can be downloaded from the Linx website at www.linxtechnologies.com.

Another area of consideration is that the data structure can affect the output power level. The FCC allows output power in the 260 to 470MHz band to be averaged over a 100ms time frame. Because OOK modulation activates the carrier for a '1' and deactivates the carrier for a '0', a data stream that sends more '0's has a lower average output power over 100ms. This allows the instantaneous output power to be increased, thus extending range.

Typical Applications

The LT Series transceiver does not perform any encoding or decoding of the data, so the designer has a great deal of flexibility in the design of a protocol for the system. The data source and destination can be any device that uses asynchronous serial data such as a PC or a microcontroller. If the application is for remote control or command, then the easiest solution is to use a remote control encoder and decoder. These ICs provide a number of data lines that can be connected to switches or buttons or even a microcontroller. When a line is taken high on the encoder, a corresponding line goes high on the decoder as long as the address matches. The Linx MT Series transcoder is an encoder and decoder in a single chip which allows bidirectional control and confirmation using a transceiver. Figure 23 shows a circuit using the Linx LICAL-TRC-MT transcoder.

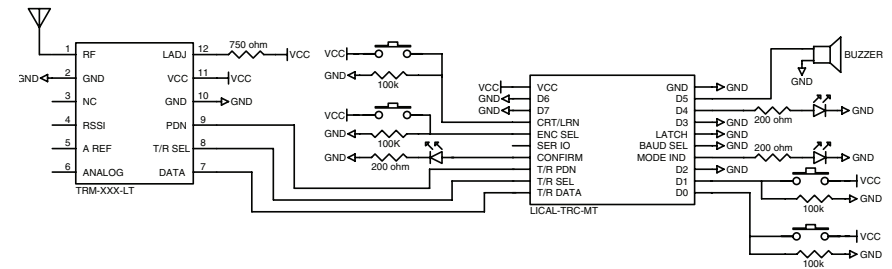

Figure 23: LT Series Transceiver and MT Series Transcoder

The MT Series has eight data lines, which can be set as inputs and connected to buttons that pull the line high when pressed, or set as outputs to activate external circuitry. When not used, the lines are pulled low by 100k-ohm resistors. The transcoder begins a transmission when any of the input data lines are taken high. When a valid transmission is received, the transcoder activates the appropriate output data lines and then sends a confirmation back to the originating transcoder. When the confirmation is received, the originating transcoder activates its CONFIRM line. In this example, this turns on an LED for visual indication. The transcoder automatically controls the power to the transceiver via the PDN line and the transmit / receive state via the T/R_SEL line.

The MT Series transcoder data guide explains this circuit and the features of the transcoder in detail, so please refer to that for more information.

A 750-ohm resistor is used on the LADJ line of the transceiver to reduce the output power of the transmitter to meet North American certification requirements. This value may need to be adjusted depending on antenna efficiency and the power allowed in the country of operation.

Antenna Considerations

The choice of antennas is a critical and often overlooked design consideration. The range, performance and legality of an RF link are critically dependent upon the antenna. While adequate antenna performance can often be obtained by trial and error methods, antenna design and matching is a complex



Figure 24: Linx Antennas

task. Professionally designed antennas such as those from Linx (Figure 24) help ensure maximum performance and FCC and other regulatory compliance.

Linx transmitter modules typically have an output power that is higher than the legal limits. This allows the designer to use an inefficient antenna such as a loop trace or helical to meet size, cost or cosmetic requirements and still achieve full legal output power for maximum range. If an efficient antenna is used, then some attenuation of the output power will likely be needed. This can easily be accomplished by using the LADJ line.

It is usually best to utilize a basic quarter-wave whip until your prototype product is operating satisfactorily. Other antennas can then be evaluated based on the cost, size and cosmetic requirements of the product. Additional details are in Application Note AN-00500.

Helpful Application Notes from Linx

It is not the intention of this manual to address in depth many of the issues that should be considered to ensure that the modules function correctly and deliver the maximum possible performance. We recommend reading the application notes listed in Figure 25 which address in depth key areas of RF design and application of Linx products. These applications notes are available online at www.linxtechnologies.com or by contacting Linx.

Helpful Application Note Titles

Note Number	Note Title
AN-00100	RF 101: Information for the RF Challenged
AN-00125	Considerations for Operation Within the 260–470MHz Band
AN-00130	Modulation Techniques for Low-Cost RF Data Links
AN-00128	Data and Bidirectional Transmissions Under Part 15.231
AN-00140	The FCC Road: Part 15 from Concept to Approval
AN-00160	Considerations for Sending Data over a Wireless Link
AN-00500	Antennas: Design, Application, Performance
AN-00501	Understanding Antenna Specifications and Operation

Figure 25: Helpful Application Note Titles

Protocol Guidelines

While many RF solutions impose data formatting and balancing requirements, Linx RF modules do not encode or packetize the signal content in any manner. The received signal will be affected by such factors as noise, edge jitter and interference, but it is not purposefully manipulated or altered by the modules. This gives the designer tremendous flexibility for protocol design and interface.

Despite this transparency and ease of use, it must be recognized that there are distinct differences between a wired and a wireless environment. Issues such as interference and contention must be understood and allowed for in the design process. To learn more about protocol considerations, read Linx Application Note AN-00160.

Interference or changing signal conditions can corrupt the data packet, so it is generally wise to structure the data being sent into small packets. This allows errors to be managed without affecting large amounts of data. A simple checksum or CRC could be used for basic error detection. Once an error is detected, the protocol designer may wish to simply discard the corrupt data or implement a more sophisticated scheme to correct it.

Interference Considerations

The RF spectrum is crowded and the potential for conflict with unwanted sources of RF is very real. While all RF products are at risk from interference, its effects can be minimized by better understanding its characteristics.

Interference may come from internal or external sources. The first step is to eliminate interference from noise sources on the board. This means paying careful attention to layout, grounding, filtering and bypassing in order to eliminate all radiated and conducted interference paths. For many products, this is straightforward; however, products containing components such as switching power supplies, motors, crystals and other potential sources of noise must be approached with care. Comparing your own design with a Linx evaluation board can help to determine if and at what level design-specific interference is present.

External interference can manifest itself in a variety of ways. Low-level interference produces noise and hashing on the output and reduces the link's overall range.

High-level interference is caused by nearby products sharing the same frequency or from near-band high-power devices. It can even come from your own products if more than one transmitter is active in the same area. It is important to remember that only one transmitter at a time can occupy a frequency, regardless of the coding of the transmitted signal. This type of interference is less common than those mentioned previously, but in severe cases it can prevent all useful function of the affected device.

Although technically not interference, multipath is also a factor to be understood. Multipath is a term used to refer to the signal cancellation effects that occur when RF waves arrive at the receiver in different phase relationships. This effect is a particularly significant factor in interior environments where objects provide many different signal reflection paths. Multipath cancellation results in lowered signal levels at the receiver and shorter useful distances for the link.

Pad Layout

The pad layout diagram in Figure 26 is designed to facilitate both hand and automated assembly.

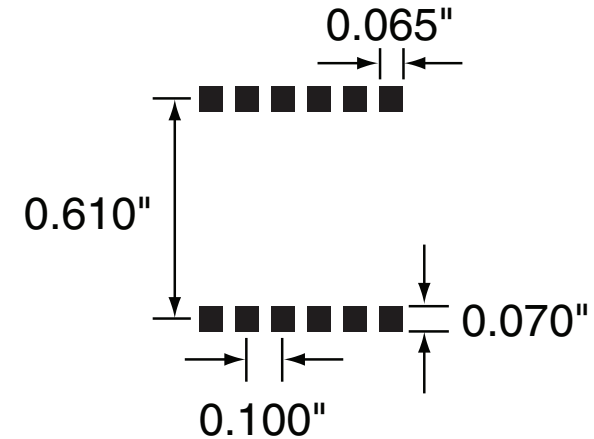

Figure 26: Recommended PCB Layout

Board Layout Guidelines

The module's design makes integration straightforward; however, it is still critical to exercise care in PCB layout. Failure to observe good layout techniques can result in a significant degradation of the module's performance. A primary layout goal is to maintain a characteristic 50-ohm impedance throughout the path from the antenna to the module. Grounding, filtering, decoupling, routing and PCB stack-up are also important considerations for any RF design. The following section provides some basic design guidelines.

During prototyping, the module should be soldered to a properly laid-out circuit board. The use of prototyping or "perf" boards results in poor performance and is strongly discouraged. Likewise, the use of sockets can have a negative impact on the performance of the module and is discouraged.

The module should, as much as reasonably possible, be isolated from other components on your PCB, especially high-frequency circuitry such as crystal oscillators, switching power supplies, and high-speed bus lines.

When possible, separate RF and digital circuits into different PCB regions.

Make sure internal wiring is routed away from the module and antenna and is secured to prevent displacement.

Do not route PCB traces directly under the module. There should not be any copper or traces under the module on the same layer as the module, just bare PCB. The underside of the module has traces and vias that could short or couple to traces on the product's circuit board.

The Pad Layout section shows a typical PCB footprint for the module. A ground plane (as large and uninterrupted as possible) should be placed on a lower layer of your PCB opposite the module. This plane is essential for creating a low impedance return for ground and consistent stripline performance.

Use care in routing the RF trace between the module and the antenna or connector. Keep the trace as short as possible. Do not pass it under the module or any other component. Do not route the antenna trace on multiple PCB layers as vias add inductance. Vias are acceptable for tying together ground layers and component grounds and should be used in multiples.

Each of the module's ground pins should have short traces tying immediately to the ground plane through a via.

Bypass caps should be low ESR ceramic types and located directly adjacent to the pin they are serving.

A 50-ohm coax should be used for connection to an external antenna. A 50-ohm transmission line, such as a microstrip, stripline or coplanar waveguide should be used for routing RF on the PCB. The Microstrip Details section provides additional information.

In some instances, a designer may wish to encapsulate or "pot" the product. There are a wide variety of potting compounds with varying dielectric properties. Since such compounds can considerably impact RF performance and the ability to rework or service the product, it is the responsibility of the designer to evaluate and qualify the impact and suitability of such materials.

Microstrip Details

A transmission line is a medium whereby RF energy is transferred from one place to another with minimal loss. This is a critical factor, especially in high-frequency products like Linx RF modules, because the trace leading to the module's antenna can effectively contribute to the length of the antenna, changing its resonant bandwidth. In order to minimize loss and detuning, some form of transmission line between the antenna and the module should be used unless the antenna can be placed very close (<1/8in) to the module. One common form of transmission line is a coax cable and another is the microstrip. This term refers to a PCB trace running over a ground plane that is designed to serve as a transmission line between the module and the antenna. The width is based on the desired characteristic impedance of the line, the thickness of the PCB and the dielectric constant of the board material. For standard 0.062in thick FR-4 board material, the trace width would be 111 mils. The correct trace width can be calculated for other widths and materials using the information in Figure 27 and examples are provided in Figure 28. Software for calculating microstrip lines is also available on the Linx website.

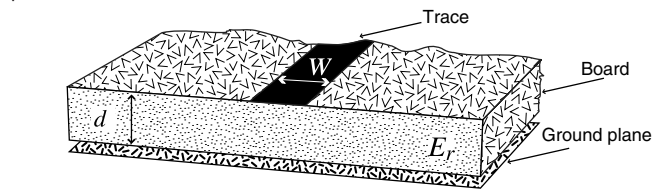

$$E_e = \frac{E_r+1}{2} + \frac{E_r-1}{2} \cdot \frac{1}{\sqrt{1+12d/W}}$$

$$Z_0 = \begin{cases} \frac{60}{\sqrt{E_e}} \cdot \ln\left(\frac{8d}{W} + \frac{W}{4d}\right) & \text{For } \frac{W}{d} \leq 1 \\ \frac{120\pi}{\sqrt{E_e} \cdot \left(\frac{W}{d} + 1.393 + 0.667 \cdot \ln\left(\frac{W}{d} + 1.444\right)\right)} & \text{For } \frac{W}{d} \geq 1 \end{cases}$$

E_r = Dielectric constant of PCB material

Figure 27: Microstrip Formulas

Example Microstrip Calculations			
Dielectric Constant	Width / Height Ratio (W / d)	Effective Dielectric Constant	Characteristic Impedance (Ω)
4.80	1.8	3.59	50.0
4.00	2.0	3.07	51.0
2.55	3.0	2.12	48.8

Figure 28: Example Microstrip Calculations

Production Guidelines

The module is housed in a hybrid SMD package that supports hand and automated assembly techniques. Since the modules contain discrete components internally, the assembly procedures are critical to ensuring the reliable function of the modules. The following procedures should be reviewed with and practiced by all assembly personnel.

Hand Assembly

Pads located on the bottom of the module are the primary mounting surface (Figure 29). Since these pads are inaccessible during mounting, castellations that run up the side of the module have been provided to facilitate solder wicking to the module's underside. This allows for very

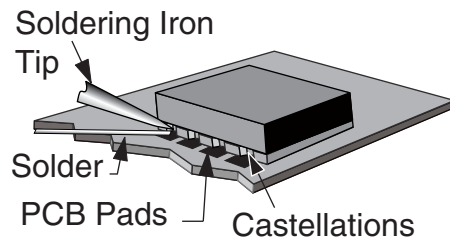

Figure 29: Soldering Technique

quick hand soldering for prototyping and small volume production. If the recommended pad guidelines have been followed, the pads will protrude slightly past the edge of the module. Use a fine soldering tip to heat the board pad and the castellation, then introduce solder to the pad at the module's edge. The solder will wick underneath the module, providing reliable attachment. Tack one module corner first and then work around the device, taking care not to exceed the times in Figure 30.

Warning: Pay attention to the absolute maximum solder times.

Absolute Maximum Solder Times

Hand Solder Temperature: +427°C for 10 seconds for lead-free alloys

Reflow Oven: +255°C max (see Figure 31)

Figure 30: Absolute Maximum Solder Times

Automated Assembly

For high-volume assembly, the modules are generally auto-placed. The modules have been designed to maintain compatibility with reflow processing techniques; however, due to their hybrid nature, certain aspects of the assembly process are far more critical than for other component types. Following are brief discussions of the three primary areas where caution must be observed.

Reflow Temperature Profile

The single most critical stage in the automated assembly process is the reflow stage. The reflow profile in Figure 31 should not be exceeded because excessive temperatures or transport times during reflow will irreparably damage the modules. Assembly personnel need to pay careful attention to the oven's profile to ensure that it meets the requirements necessary to successfully reflow all components while still remaining within the limits mandated by the modules. The figure below shows the recommended reflow oven profile for the modules.

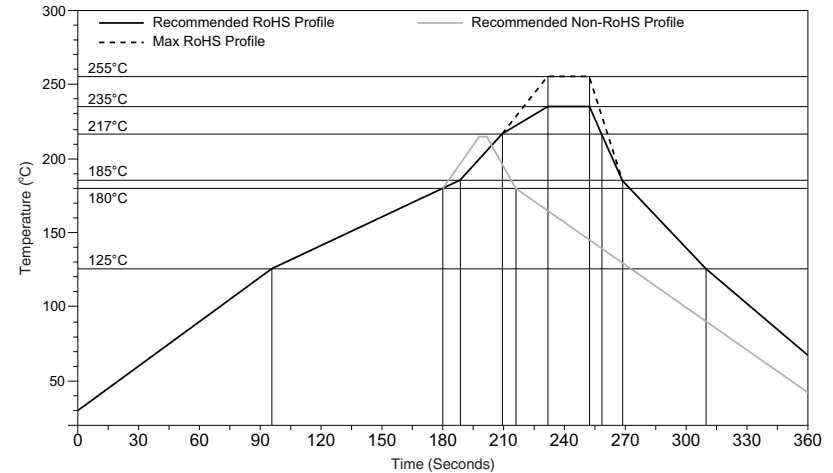

Figure 31: Maximum Reflow Temperature Profile

Shock During Reflow Transport

Since some internal module components may reflow along with the components placed on the board being assembled, it is imperative that the modules not be subjected to shock or vibration during the time solder is liquid. Should a shock be applied, some internal components could be lifted from their pads, causing the module to not function properly.

Washability

The modules are wash-resistant, but are not hermetically sealed. Linx recommends wash-free manufacturing; however, the modules can be subjected to a wash cycle provided that a drying time is allowed prior to applying electrical power to the modules. The drying time should be sufficient to allow any moisture that may have migrated into the module to evaporate, thus eliminating the potential for shorting damage during power-up or testing. If the wash contains contaminants, the performance may be adversely affected, even after drying.

General Antenna Rules

The following general rules should help in maximizing antenna performance.

1. Proximity to objects such as a user's hand, body or metal objects will cause an antenna to detune. For this reason, the antenna shaft and tip should be positioned as far away from such objects as possible.
2. Optimum performance is obtained from a $\frac{1}{4}$ - or $\frac{1}{2}$ -wave straight whip mounted at a right angle to the ground plane (Figure 32). In many cases, this isn't desirable for practical or ergonomic reasons, thus, an alternative antenna style such as a helical, loop or patch may be utilized and the corresponding sacrifice in performance accepted.

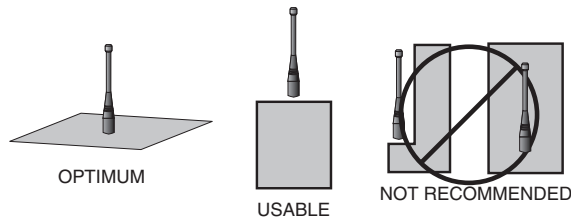

Figure 32: Ground Plane Orientation

3. If an internal antenna is to be used, keep it away from other metal components, particularly large items like transformers, batteries, PCB tracks and ground planes. In many cases, the space around the antenna is as important as the antenna itself. Objects in close proximity to the antenna can cause direct detuning, while those farther away will alter the antenna's symmetry.
4. In many antenna designs, particularly $\frac{1}{4}$ -wave whips, the ground plane acts as a counterpoise, forming, in essence, a $\frac{1}{2}$ -wave dipole (Figure 33). For this reason, adequate ground plane area is essential. The ground plane can be a metal case or ground-fill areas on a circuit board. Ideally, it should have a surface area less than or equal to the overall length of the $\frac{1}{4}$ -wave radiating element. This is often not practical due to size and configuration constraints. In these instances, a designer must make the best use of the area available to create as much ground

VERTICAL $\lambda/4$ GROUNDED ANTENNA (MARCONI)

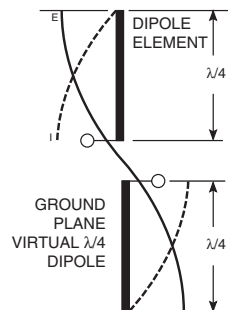

Figure 33: Dipole Antenna

plane as possible in proximity to the base of the antenna. In cases where the antenna is remotely located or the antenna is not in close proximity to a circuit board, ground plane or grounded metal case, a metal plate may be used to maximize the antenna's performance.

5. Remove the antenna as far as possible from potential interference sources. Any frequency of sufficient amplitude to enter the receiver's front end will reduce system range and can even prevent reception entirely. Switching power supplies, oscillators or even relays can also be significant sources of potential interference. The single best weapon against such problems is attention to placement and layout. Filter the module's power supply with a high-frequency bypass capacitor. Place adequate ground plane under potential sources of noise to shunt noise to ground and prevent it from coupling to the RF stage. Shield noisy board areas whenever practical.
6. In some applications, it is advantageous to place the module and antenna away from the main equipment (Figure 34). This can avoid interference problems and allows the antenna to be oriented for optimum performance. Always use 50Ω coax, like RG-174, for the remote feed.

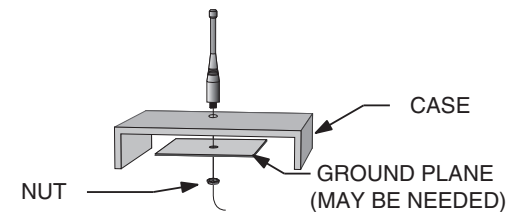

Figure 34: Remote Ground Plane

Common Antenna Styles

There are hundreds of antenna styles and variations that can be employed with Linx RF modules. Following is a brief discussion of the styles most commonly utilized. Additional antenna information can be found in Linx Application Notes AN-00100, AN-00140, AN-00500 and AN-00501. Linx antennas and connectors offer outstanding performance at a low price.

Whip Style

A whip style antenna (Figure 35) provides outstanding overall performance and stability. A low-cost whip can be easily fabricated from a wire or rod, but most designers opt for the consistent performance and cosmetic appeal of a professionally-made model. To meet this need, Linx offers a wide variety of straight and reduced height whip style antennas in permanent and connectorized mounting styles.



Figure 35: Whip Style Antennas

The wavelength of the operational frequency determines an antenna's overall length. Since a full wavelength is often quite long, a partial 1/2- or 1/4-wave antenna is normally employed. Its size and natural radiation resistance make it well matched to Linx modules. The proper length for a straight 1/4-wave can be easily determined using the formula in Figure 36. It is also possible to reduce the overall height of the antenna by using a helical winding. This reduces the antenna's bandwidth but is a great way to minimize the antenna's physical size for compact applications. This also means that the physical appearance is not always an indicator of the antenna's frequency.

$$L = \frac{234}{F_{\text{MHz}}}$$

Figure 36:
L = length in feet of quarter-wave length
F = operating frequency in megahertz

Specialty Styles

Linx offers a wide variety of specialized antenna styles (Figure 37). Many of these styles utilize helical elements to reduce the overall antenna size while maintaining reasonable performance. A helical antenna's bandwidth is often quite narrow and the antenna can detune in proximity to other objects, so care must be exercised in layout and placement.



Figure 37: Specialty Style Antennas

Loop Style

A loop or trace style antenna is normally printed directly on a product's PCB (Figure 38). This makes it the most cost-effective of antenna styles. The element can be made self-resonant or externally resonated with discrete components, but its actual layout is usually product specific. Despite the cost advantages, loop style antennas are generally inefficient and useful only for short range applications. They are also very sensitive to changes in layout and PCB dielectric, which can cause consistency issues during production. In addition, printed styles are difficult to engineer, requiring the use of expensive equipment including a network analyzer. An improperly designed loop will have a high VSWR at the desired frequency which can cause instability in the RF stage.

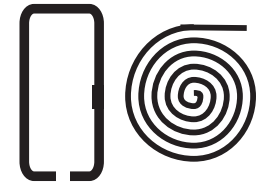

Figure 38: Loop or Trace Antenna

Linx offers low-cost planar (Figure 39) and chip antennas that mount directly to a product's PCB. These tiny antennas do not require testing and provide excellent performance despite their small size. They offer a preferable alternative to the often problematic "printed" antenna.



Figure 39: SP Series "Splatch" and uSP "MicroSplatch" Antennas

Regulatory Considerations

Note: Linx RF modules are designed as component devices that require external components to function. The purchaser understands that additional approvals may be required prior to the sale or operation of the device, and agrees to utilize the component in keeping with all laws governing its use in the country of operation.

When working with RF, a clear distinction must be made between what is technically possible and what is legally acceptable in the country where operation is intended. Many manufacturers have avoided incorporating RF into their products as a result of uncertainty and even fear of the approval and certification process. Here at Linx, our desire is not only to expedite the design process, but also to assist you in achieving a clear idea of what is involved in obtaining the necessary approvals to legally market a completed product.

For information about regulatory approval, read AN-00142 on the Linx website or call Linx. Linx designs products with worldwide regulatory approval in mind.

In the United States, the approval process is actually quite straightforward. The regulations governing RF devices and the enforcement of them are the responsibility of the Federal Communications Commission (FCC). The regulations are contained in Title 47 of the United States Code of Federal Regulations (CFR). Title 47 is made up of numerous volumes; however, all regulations applicable to this module are contained in Volume 0-19. It is strongly recommended that a copy be obtained from the FCC's website, the Government Printing Office in Washington or from your local government bookstore. Excerpts of applicable sections are included with Linx evaluation kits or may be obtained from the Linx Technologies website, www.linxtechnologies.com. In brief, these rules require that any device that intentionally radiates RF energy be approved, that is, tested for compliance and issued a unique identification number. This is a relatively painless process. Final compliance testing is performed by one of the many independent testing laboratories across the country. Many labs can also provide other certifications that the product may require at the same time, such as UL, CLASS A / B, etc. Once the completed product has passed, an ID number is issued that is to be clearly placed on each product manufactured.

Questions regarding interpretations of the Part 2 and Part 15 rules or the measurement procedures used to test intentional radiators such as Linx RF modules for compliance with the technical standards of Part 15 should be addressed to:

Federal Communications Commission
Equipment Authorization Division
Customer Service Branch, MS 1300F2
7435 Oakland Mills Road
Columbia, MD, US 21046
Phone: + 1 301 725 585 | Fax: + 1 301 344 2050
Email: labinfo@fcc.gov

ETSI Secretaria
650, Route des Lucioles
06921 Sophia-Antipolis Cedex
FRANCE
Phone: +33 (0)4 92 94 42 00
Fax: +33 (0)4 93 65 47 16

International approvals are slightly more complex, although Linx modules are designed to allow all international standards to be met. If the end product is to be exported to other countries, contact Linx to determine the specific suitability of the module to the application.

All Linx modules are designed with the approval process in mind and thus much of the frustration that is typically experienced with a discrete design is eliminated. Approval is still dependent on many factors, such as the choice of antennas, correct use of the frequency selected and physical packaging. While some extra cost and design effort are required to address these issues, the additional usefulness and profitability added to a product by RF makes the effort more than worthwhile.

TE TECHNICAL SUPPORT CENTER

USA:	+1 (800) 522-6752
Canada:	+1 (905) 475-6222
Mexico:	+52 (0) 55-1106-0800
Latin/S. America:	+54 (0) 11-4733-2200
Germany:	+49 (0) 6251-133-1999
UK:	+44 (0) 800-267666
France:	+33 (0) 1-3420-8686
Netherlands:	+31 (0) 73-6246-999
China:	+86 (0) 400-820-6015

te.com

TE Connectivity, TE, TE connectivity (logo), Linx and Linx Technologies are trademarks owned or licensed by the TE Connectivity Ltd. family of companies. All other logos, products and/or company names referred to herein might be trademarks of their respective owners.

The information given herein, including drawings, illustrations and schematics which are intended for illustration purposes only, is believed to be reliable. However, TE Connectivity makes no warranties as to its accuracy or completeness and disclaims any liability in connection with its use. TE Connectivity's obligations shall only be as set forth in TE Connectivity's Standard Terms and Conditions of Sale for this product and in no case will TE Connectivity be liable for any incidental, indirect or consequential damages arising out of the sale, resale, use or misuse of the product. Users of TE Connectivity products should make their own evaluation to determine the suitability of each such product for the specific application.

TE Connectivity warrants to the original end user customer of its products that its products are free from defects in material and workmanship. Subject to conditions and limitations TE Connectivity will, at its option, either repair or replace any part of its products that prove defective because of improper workmanship or materials. This limited warranty is in force for the useful lifetime of the original end product into which the TE Connectivity product is installed. Useful lifetime of the original end product may vary but is not warranted to exceed one (1) year from the original date of the end product purchase.

©2023 TE Connectivity. All Rights Reserved.

06/23 Original
