

2-100716-1 ✓ ACTIVE

AMP-TY

TE Internal #: 2-100716-1

Cable Ties, Screw Mounting, Box & Carton, 200Newton Tensile Strength, 45lbf Tensile Strength, Cable Tie Length 200 mm [7.9 in]

[View on TE.com >](#)



Wire & Cable > Wire & Cable Accessories > Cable Ties

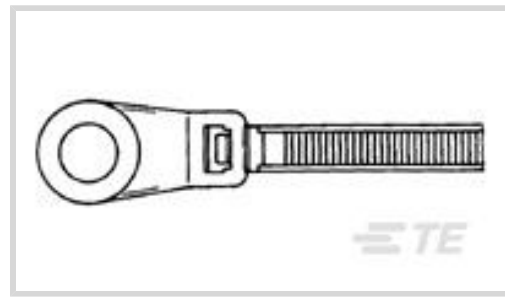

Cable Tie Style: **Screw Mounting**

Cable Tie Packaging Method: **Box & Carton**

Tensile Strength: **45 lbf**

Cable Tie Length: **200 mm [ 7.9 in ]**

## Features

### Product Type Features

Product Type	Cable Tie
Cable Tie Style	Screw Mounting
Tensile Strength	45 lbf

### Body Features

Cable Tie Color	Natural
Cable Tie Material	Polyamide 6.6 GF

### Dimensions

Bundle Range Diameter	54 mm[2.13 in]
Cable Tie Length	200 mm[7.9 in]
Cable Tie Width	4.8 mm[.189 in]
Cable Tie Thickness	1.27 mm[.05 in]

### Packaging Features

Cable Tie Packaging Method	Box & Carton
Cable Tie Packaging Quantity	100

## Product Compliance

[For compliance documentation, visit the product page on TE.com>](#)









EU RoHS Directive 2011/65/EU	Compliant
EU ELV Directive 2000/53/EC	Compliant

China RoHS 2 Directive MIIT Order No 32, 2016	No Restricted Materials Above Threshold
EU REACH Regulation (EC) No. 1907/2006	Current ECHA Candidate List: JUN 2020 (209) Candidate List Declared Against: JAN 2020 (205) SVHC > Threshold: Not Yet Reviewed
Halogen Content	Not Yet Reviewed for halogen content
Solder Process Capability	Not applicable for solder process capability

Product Compliance Disclaimer

This information is provided based on reasonable inquiry of our suppliers and represents our current actual knowledge based on the information they provided. This information is subject to change. The part numbers that TE has identified as EU RoHS compliant have a maximum concentration of 0.1% by weight in homogenous materials for lead, hexavalent chromium, mercury, PBB, PBDE, DBP, BBP, DEHP, DIBP, and 0.01% for cadmium, or qualify for an exemption to these limits as defined in the Annexes of Directive 2011/65/EU (RoHS2). Finished electrical and electronic equipment products will be CE marked as required by Directive 2011/65/EU. Components may not be CE marked. Additionally, the part numbers that TE has identified as EU ELV compliant have a maximum concentration of 0.1% by weight in homogenous materials for lead, hexavalent chromium, and mercury, and 0.01% for cadmium, or qualify for an exemption to these limits as defined in the Annexes of Directive 2000/53/EC (ELV). Regarding the REACH Regulation, the information TE provides on SVHC in articles for this part number is based on the latest European Chemicals Agency (ECHA) 'Guidance on requirements for substances in articles' posted at this URL: <https://echa.europa.eu/guidance-documents/guidance-on-reach>

## Compatible Parts

 <p>TE Part # CAT-T3437-C6298 CM-SCE-TP MILITARY GRADE MARKERS</p>	 <p>TE Part # CAT-T3437-K1 K-TYPE TIE-ON MARKERS</p>	 <p>TE Part # CAT-T3437-H85999 HTCM-SCE-TP HIGH TEMPERATURE MARKERS</p>	 <p>TE Part # EC6406-000 13611101</p>
 <p>TE Part # EC6504-000 13611505</p>	 <p>TE Part # EC6409-000 13611202</p>	 <p>TE Part # EC6453-000 13611303</p>	 <p>TE Part # EC6513-000 13611707</p>



TE Part # EC6496-000  
13611442



TE Part # EC6405-000  
13611000



TE Part # EC6505-000  
13611606



TE Part # EC6518-000  
13611808



TE Part # A81411-000  
HTCM-SCE-TP-1/2-6H-4



TE Part # CP0394-000  
CM-SCE-TP-1/2-4H-5



TE Part # 0628890001  
CM-SCE-1/2-4H-2L



TE Part # 769192-000  
CM-SCE-1/4-4H-2L



TE Part # 6622650001  
CM-SCE-1/2-6H-4



TE Part # EC6562-000  
13611942



TE Part # 0325090001  
CM-SCE-1/2-6H-9



TE Part # D86901-000  
HTCM-SCE-TP-2.5K-1/2-4H-4

### Customers Also Bought



TE Part #6609035-3  
CORCOM SK SERIES SINGLE PHASE FILTERS

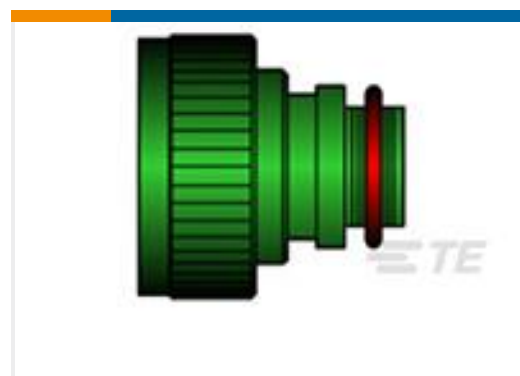

TE Part #946841-000  
TXR18AB00-1407AI

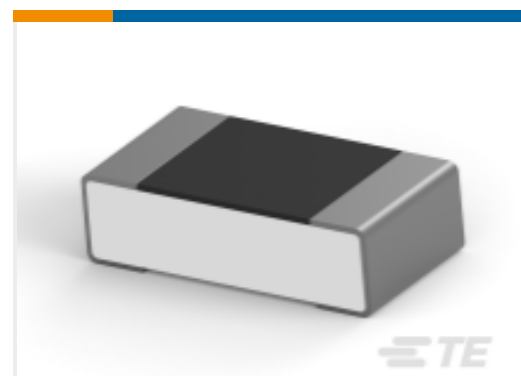

TE Part #1-2176365-2  
RQ 0603 52R3 0.1% 10PPM 1K RL



TE Part #2-1624116-7  
BMB-A 0603 60R N8

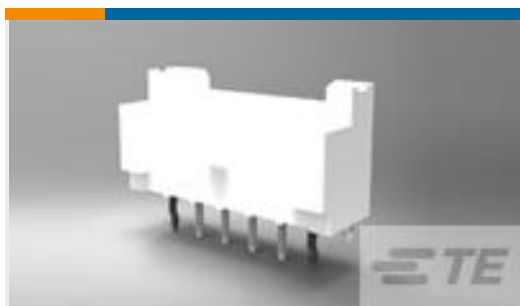

TE Part #1-1744439-6  
EP2.5 Shrd HDR ASSY 16P VERT, GW



TE Part #3-1971817-3  
3P,RAST 2.5 Tab Header,Ex- Locking, THV

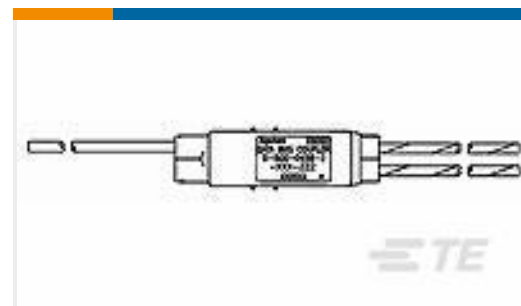

TE Part #517179-000  
D-500-0458-2-612-012

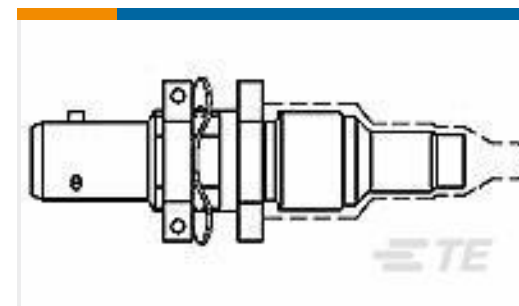

TE Part #928733-000  
DK-621-0934-1S



## Documents

### Product Drawings

CABLE TY 200X4,8NAT

English