

The PT9301 is a combination position and velocity transducer for demanding long-range applications requiring a linear position measurements in ranges up to 1700". A precision plastic-hybrid potentiometer provides accurate position feedback while a self-generating DC tachometer provides a velocity signal that is proportional to the speed of the traveling stainless-steel measuring cable.

As a member of Celesco's innovative family of NEMA-4 rated cable-extension transducers, the PT9301 offers numerous benefits. It installs in minutes, functions properly without perfectly parallel alignment, and when its cable is retracted, it measures only 6".

### Output Signal

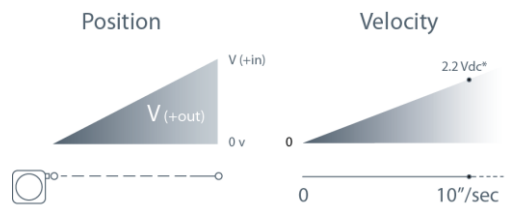

\*velocity output rate = 361 mV ± 3% @ 100 inches per min.

## PT9301

### Cable Actuated Sensor Heavy Industrial • Position/Velocity Output

**Linear Position/Velocity to 550 inches (1400 cm)**  
**Rugged Powder-Painted Aluminum Enclosure**  
**VLS Option to Prevent Free-Release Damage**  
**IP68 • NEMA 6 Protection**

#### General

<b>Full Stroke Range</b>	0-75 to 0-550 inches
<b>Measuring Cable Options</b>	stainless steel or thermoplastic
<b>Enclosure Material</b>	powder-painted aluminum
<b>Sensor, Position</b>	plastic-hybrid precision potentiometer
<b>Sensor, Velocity</b>	DC tach generator
<b>Maximum Retraction</b>	see ordering information
<b>Acceleration</b>	
<b>Maximum Velocity</b>	see ordering information
<b>Weight, Aluminum</b>	8 lbs. (16 lbs.) max.
<b>(Stainless Steel) Enclosure</b>	

#### Position

<b>Output Signal</b>	voltage divider (potentiometer)
<b>Accuracy</b>	± 0.10% full stroke
<b>Repeatability</b>	± 0.02% full stroke
<b>Resolution</b>	essentially infinite
<b>Sensor, Position</b>	plastic-hybrid precision potentiometer
<b>Potentiometer Cycle Life</b>	≥250,000
<b>Input Resistance Options</b>	500, 1K, 5K or 10K Ω (see ordering information)
<b>Power Rating, Watts</b>	2.0 at 70°F derated to 0 at 250°F
<b>Recommended Maximum Input Voltage</b>	30V (AC/DC)
<b>Output Signal Change Over</b>	94% ±4% of input voltage
<b>Full Stroke Range</b>	

#### Velocity

<b>Output Signal</b>	DC tachometer output
<b>Linearity</b>	better than ±0.10% of output at any velocity
<b>Repeatability</b>	±0.10% of reading
<b>Sensor</b>	tach generator
<b>Input Voltage</b>	none required
<b>Output Voltage @ 100 inches per minute</b>	361 mV ±3%
<b>Output Impedance</b>	350 ohms ±10%
<b>Output Ripple (for velocity ≥ 1.29 inches per second)</b>	±3% rms

#### Environmental

<b>Enclosure</b>	NEMA 4/4X/6, IP 67/68
<b>Operating Temperature</b>	-40° to 200°F (-40° to 90°C)
<b>Vibration</b>	up to 10 g to 2000 Hz maximum

# PT9301

Heavy Industrial • Position/Velocity Output

Fig. 1 – Outline Drawing (18 oz. cable tension only)

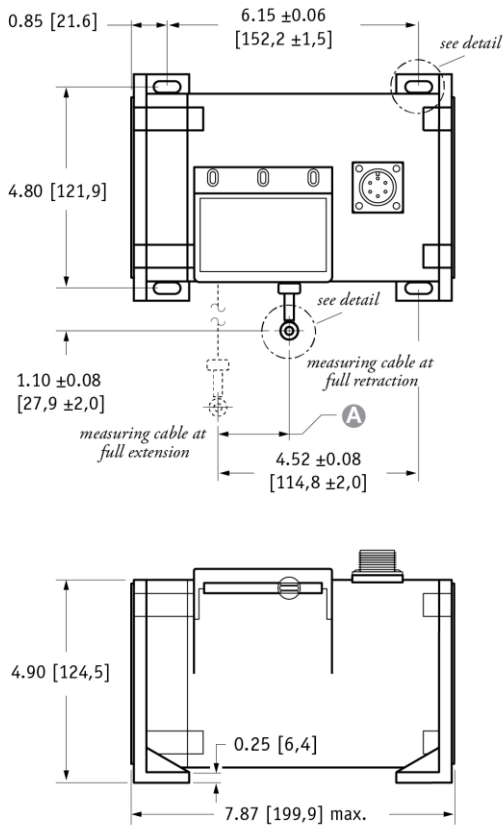

DIMENSIONS ARE IN INCHES [MM]  
tolerances are 0.03 IN. [0.5 MM] unless otherwise noted.

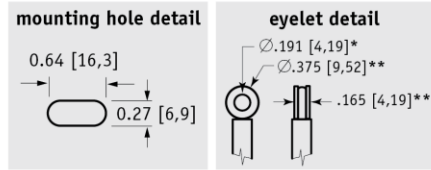

### A DIMENSION (INCHES)

RANGE	MEASURING CABLE			
	Ø.031 in.	Ø.034 in.	Ø.047 in.	Ø.062 in.
75	n/a	0.22	0.29	0.37
100	n/a	0.29	0.39	0.49
150	n/a	0.44	0.59	0.73
200	n/a	0.58	0.79	0.98
250	n/a	0.73	0.98	1.22
300	n/a	0.88	1.18	1.47
350	n/a	1.02	1.38	1.71
400	n/a	1.17	1.57	1.96
450	n/a	1.31	1.77	n/a
500	n/a	1.46	1.97	n/a
550	1.61	1.61	n/a	n/a

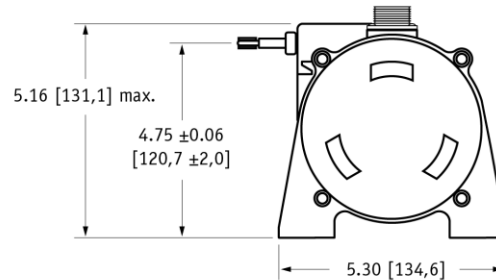

\* tolerance = +.005 -.001 [+.13 -.03]  
\*\* tolerance = +.005 -.005 [+.13 -.13]

## Ordering Information

### Model Number:

**PT9301** -      -      -      -      -      -      -      -       
order code:      **R**      **A**      **B**      **C**      **D**      **E**      **F**      **G**

### Sample Model Number:

**PT9301 - 0500 - 111 - 1110**

- R** range: 500 inches
- A** enclosure/cable tension: aluminum/18 oz.
- B** measuring cable: .034 nylon-coated stainless
- C** cable exit: front
- D** output signal: 500 ohm position / DC tachometer velocity
- F** electrical connection: 6-pin plastic connector

### Full Stroke Range:

<b>R</b> order code:	<b>0075</b>	<b>0100</b>	<b>0150</b>	<b>0200</b>	<b>0250</b>	<b>0300</b>	<b>0350</b>	<b>0400</b>	<b>0450*</b>	<b>0500*</b>	<b>0550*</b>
full stroke range, min:	75 in.	100 in.	150 in.	200 in.	250 in.	300 in.	350 in.	400 in.	450 in.	500 in.	550 in.

\* - 36 oz. cable tension strongly recommended

### Enclosure Material and Measuring Cable Tension:

<b>A</b> order code:	<b>1</b>	<b>2</b>
tension (±30%):	18 oz.	36 oz.
enclosure material:	powder-painted aluminum	powder-painted aluminum
max. acceleration:	1 g	5 g
max. velocity:	60 inches/sec	200 inches/sec

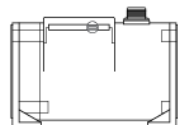

standard housing  
see fig 1.

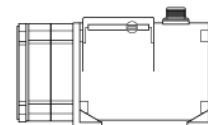

dual-spring housing  
see fig 2.

# PT9301

Heavy Industrial • Position/Velocity Output



## Measuring Cable:

order code:	1	2	3	4
cable construction:	Ø.034-inch nylon-coated stainless steel rope	Ø.047-inch bare stainless steel rope	Ø.058-inch PVC jacketed vectra fiber rope	Ø.031-inch bare stainless steel rope
available ranges:	<i>all ranges</i>	<i>all ranges up to 500 inches</i>	<i>all ranges up to 400 inches</i>	<i>550-inch range only</i>
general use:	indoor	outdoor, debris, high temperature	high voltage or magnetic field	outdoor, debris, high temperature

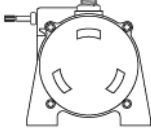
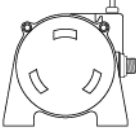
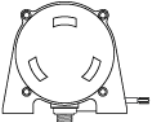
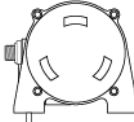

## Cable Exit:

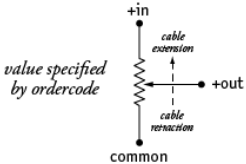
order code:	1	2	3	4
	front	top	back	down
				

## Output Signals:

order code:	1	2	3	4
position sensing potentiometer:	500 ohms*	1000 ohms*	5000 ohms*	10,000 ohms*
position sensing circuit	 <p><i>value specified by ordercode</i></p>			
	*—tolerance = ±10%			

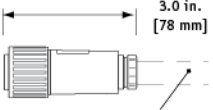
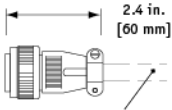
## Electrical Connection:

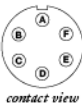
order code:	1	3	4																																			
	6-pin plastic connector with mating plug IP 67, NEMA 4X*, 6	6-pin metal connector with mating plug IP 65, NEMA 4	25-ft. instrumentation cable 24 AWG, shielded IP 67, NEMA 6																																			
																																						
	1/2 - 5/16" [14 - 8 mm] cable dia. 16 AWG max conductor size connector: MS3102E-14S-6P mating plug: MS3106E-14S-6S	3/8-in. [9 mm] max cable dia. 16 AWG max conductor size connector: MS3102E-14S-6P mating plug: MS3106E-14S-6S	25 ft. x 0.2-in. dia. [7,5 M x 5 mm dia.] 24 AWG, shielded																																			
	<b>6-pin mating plug:</b> <table border="0"> <tr> <td>pin</td> <td>signal</td> <td rowspan="2">} position</td> </tr> <tr> <td>A</td> <td>+ in</td> </tr> <tr> <td>B</td> <td>common</td> <td rowspan="2">} velocity</td> </tr> <tr> <td>C</td> <td>+ out</td> </tr> <tr> <td>D</td> <td>-</td> <td></td> </tr> <tr> <td>E</td> <td>+ out</td> <td></td> </tr> <tr> <td>F</td> <td>- out</td> <td></td> </tr> </table>		pin	signal	} position	A	+ in	B	common	} velocity	C	+ out	D	-		E	+ out		F	- out		<b>25-ft. instrumentation cable:</b> <table border="0"> <tr> <td>color</td> <td>signal</td> <td rowspan="2">} position</td> </tr> <tr> <td>red</td> <td>+ in</td> </tr> <tr> <td>black</td> <td>common</td> <td rowspan="2">} velocity</td> </tr> <tr> <td>green</td> <td>+ out</td> </tr> <tr> <td>white</td> <td>+ out</td> <td></td> </tr> <tr> <td>brown</td> <td>- out</td> <td></td> </tr> </table>	color	signal	} position	red	+ in	black	common	} velocity	green	+ out	white	+ out		brown	- out	
pin	signal	} position																																				
A	+ in																																					
B	common	} velocity																																				
C	+ out																																					
D	-																																					
E	+ out																																					
F	- out																																					
color	signal	} position																																				
red	+ in																																					
black	common	} velocity																																				
green	+ out																																					
white	+ out																																					
brown	- out																																					
	 <p>contact view</p>																																					

\*—applies to stainless steel enclosure only

**Fig. 2 – Outline Drawing (36 oz. cable tension only)**

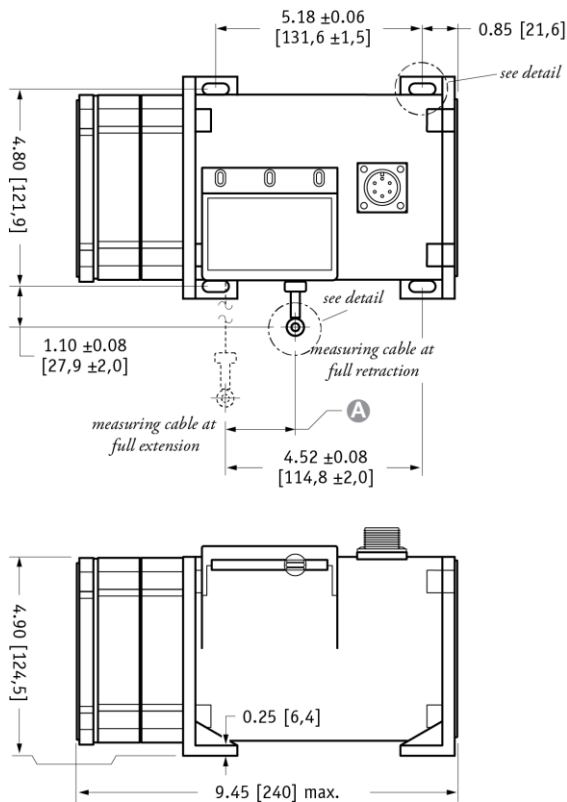

DIMENSIONS ARE IN INCHES [MM]  
tolerances are 0.03 IN. [0.5 MM] unless otherwise noted.

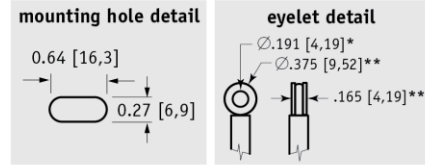

**A DIMENSION (INCHES)**

RANGE	MEASURING CABLE			
	Ø.031 in.	Ø.034 in.	Ø.047 in.	Ø.062 in.
75	n/a	0.22	0.29	0.37
100	n/a	0.29	0.39	0.49
150	n/a	0.44	0.59	0.73
200	n/a	0.58	0.79	0.98
250	n/a	0.73	0.98	1.22
300	n/a	0.88	1.18	1.47
350	n/a	1.02	1.38	1.71
400	n/a	1.17	1.57	1.96
450	n/a	1.31	1.77	n/a
500	n/a	1.46	1.97	n/a
550	1.61	1.61	n/a	n/a

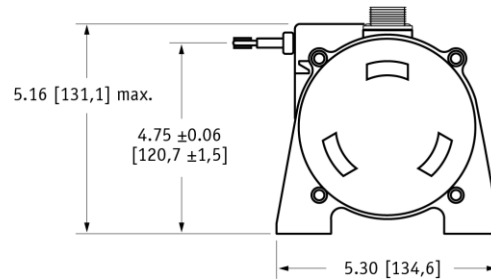

\* tolerance = +.005 -.001 [+13 -.03]  
\*\* tolerance = +.005 -.005 [+13 -.13]

**NORTH AMERICA**

Measurement Specialties, Inc.,  
a TE Connectivity company  
20630 Plummer Street  
Chatsworth, CA 91311  
Tel +1 800 423 5483  
Tel +1 818 701 2750  
Fax +1 818 701 2799  
info@celesco.com

**TE.com/sensorsolutions**

Measurement Specialties, Inc., a TE Connectivity company.

Measurement Specialties, TE Connectivity, TE Connectivity (logo) and EVERY CONNECTION COUNTS are trademarks. All other logos, products and/or company names referred to herein might be trademarks of their respective owners.

The information given herein, including drawings, illustrations and schematics which are intended for illustration purposes only, is believed to be reliable. However, TE Connectivity makes no warranties as to its accuracy or completeness and disclaims any liability in connection with its use. TE Connectivity's obligations shall only be as set forth in TE Connectivity's Standard Terms and Conditions of Sale for this product and in no case will TE Connectivity be liable for any incidental, indirect or consequential damages arising out of the sale, resale, use or misuse of the product. Users of TE Connectivity products should make their own evaluation to determine the suitability of each such product for the specific application.

© 2015 TE Connectivity Ltd. family of companies All Rights Reserved.

PT9301 12/01/2015