



ANT-2.4-MSA-TH1

Stamped Metal 2.4 GHz ISM/Bluetooth Antenna

The ANT-2.4-MSA-TH1 is a stamped metal antenna designed for 2.4 GHz ISM applications including Bluetooth® and ZigBee®, as well as single-band WiFi.

The ANT-2.4-MSA-TH1 exhibits excellent performance in a compact size (16.7 mm x 5.8 mm). It is packaged in trays and is designed for through-hole mounting directly to a printed circuit board.

FEATURES

- Performance at 2.4 GHz to 2.5 GHz
 - VSWR: ≤ 1.3
 - Peak Gain: 3.7 dBi
 - Efficiency: 87%
- Compact, low-profile
 - 16.7 mm x 5.8 mm x 5.4 mm
- Omnidirectional radiation pattern
- Reflow- or hand-solder assembly

APPLICATIONS

- 2.4 GHz ISM
 - Bluetooth®
 - ZigBee®
- Single-band WiFi/802.11
- Sensing and remote monitoring
- Hand-held devices
- Internet of Things (IoT) devices

ORDERING INFORMATION

Part Number	Description
ANT-2.4-MSA-TH1	Through-hole PCB-mount stamped metal ISM/Bluetooth antenna
AEK-2.4-MSA-TH1	Antenna evaluation kit

Available from Linx Technologies and select distributors and representatives.

TABLE 1. ELECTRICAL SPECIFICATIONS

Parameter	Value
Frequency Range	2.4 GHz to 2.5 GHz
VSWR (max)	1.3
Peak Gain (dBi)	3.7
Average Gain (dBi)	-0.7
Efficiency (%)	87

Electrical specifications and plots measured with a 40.0 mm x 50.0 mm (1.57 in x 1.97 in) reference ground plane.

TABLE 2. MECHANICAL SPECIFICATIONS

Parameter	Value
Polarization	Linear
Radiation	Omnidirectional
Max Power	1 W
Wavelength	1/4-wave
Electrical Type	Monopole
Impedance	50 Ω
Operating Temp. Range	-40 °C to +85 °C
Dimensions	16.7 mm x 5.8 mm x 5.4 mm (0.66 in x 0.23 in x 0.21 in)
Connection	Through-hole solder
Weight	0.3 g (0.01 oz)

PACKAGING DIMENSIONS

Figure 1 provides dimensions for the ANT-2.4-MSA-TH1 antenna

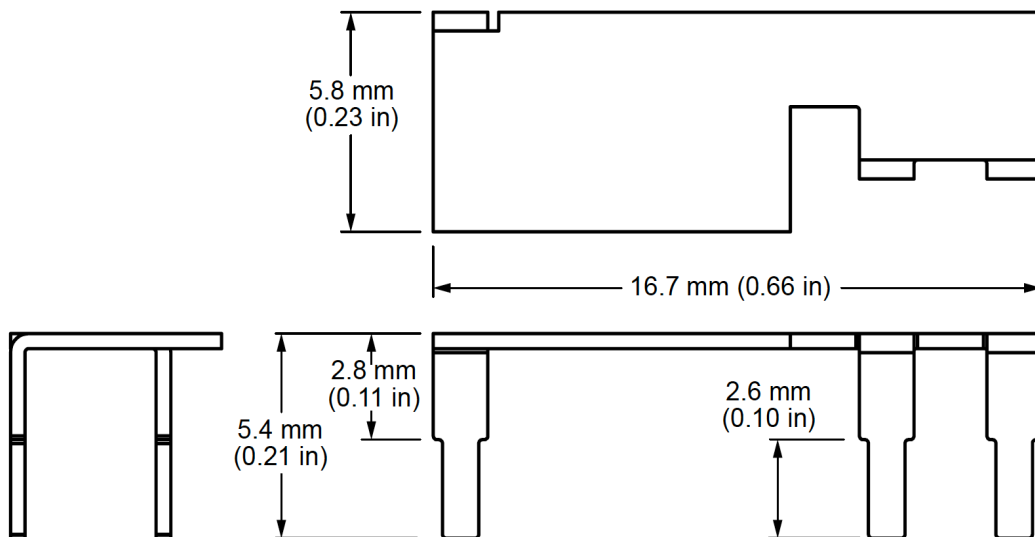

Figure 1. ANT-2.4-MSA-TH1 Antenna Dimensions

ANTENNA PACKAGING

The ANT-2.4-MSA-TH1 antenna is sealed in plastic trays in quantities of 15 pcs. Trays are sealed in polyethylene bags in quantities of 500 pcs. Three bags are placed in an inner-carton (1500 pcs). Four cartons are placed in an outer-carton for 6000 pcs. Distribution channels may offer alternative packaging options.

ANTENNA ORIENTATION

The ANT-2.4-MSA-TH1 antenna is characterized on a ground plane as shown in Figure 2. Characterization with an adjacent ground plane (40 mm x 50 mm) provides insight into antenna performance when attached directly to a printed circuit board mounted connector. This orientation represents the most common endproduct use case.

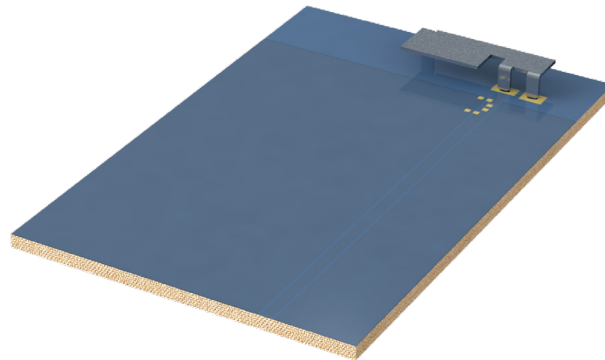

Figure 2. ANT-2.4-MSA-TH1 Test Orientation

VSWR

Figure 3 provides the voltage standing wave ratio (VSWR) across the antenna bandwidth. VSWR describes the power reflected from the antenna back to the radio. A lower VSWR value indicates better antenna performance at a given frequency. Reflected power is also shown on the right-side vertical axis as a gauge of the percentage of transmitter power reflected back from the antenna.

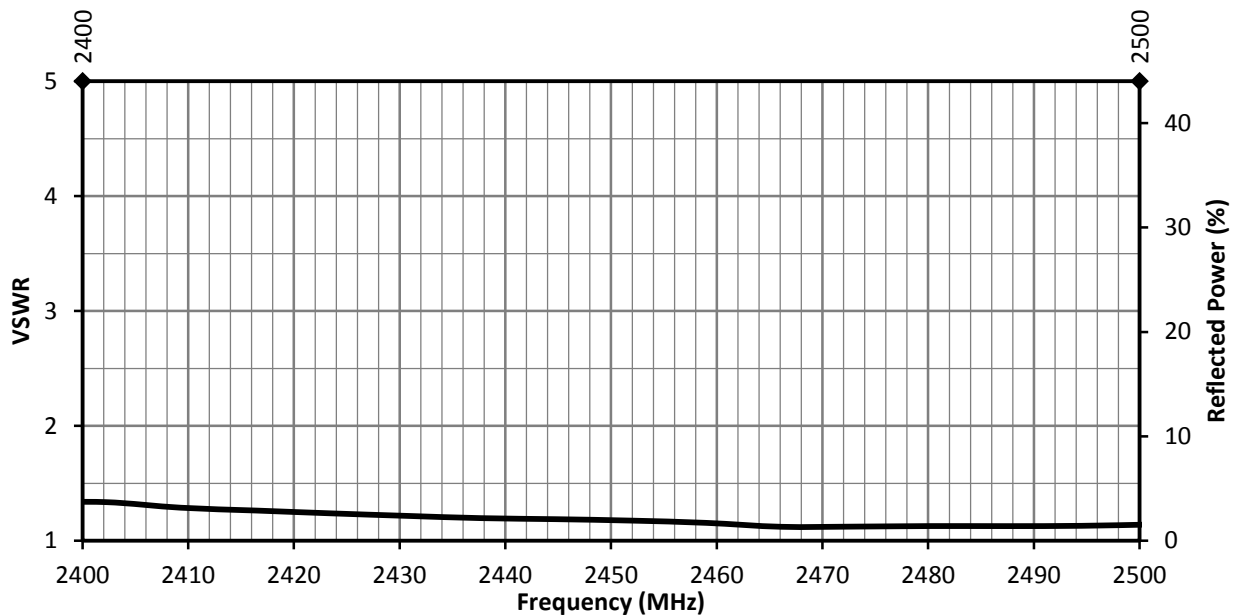

Figure 3. ANT-2.4-MSA-TH1 Antenna VSWR

RETURN LOSS

Return loss (Figure 4), represents the loss in power at the antenna due to reflected signals. Like VSWR, a lower return loss value indicates better antenna performance at a given frequency.

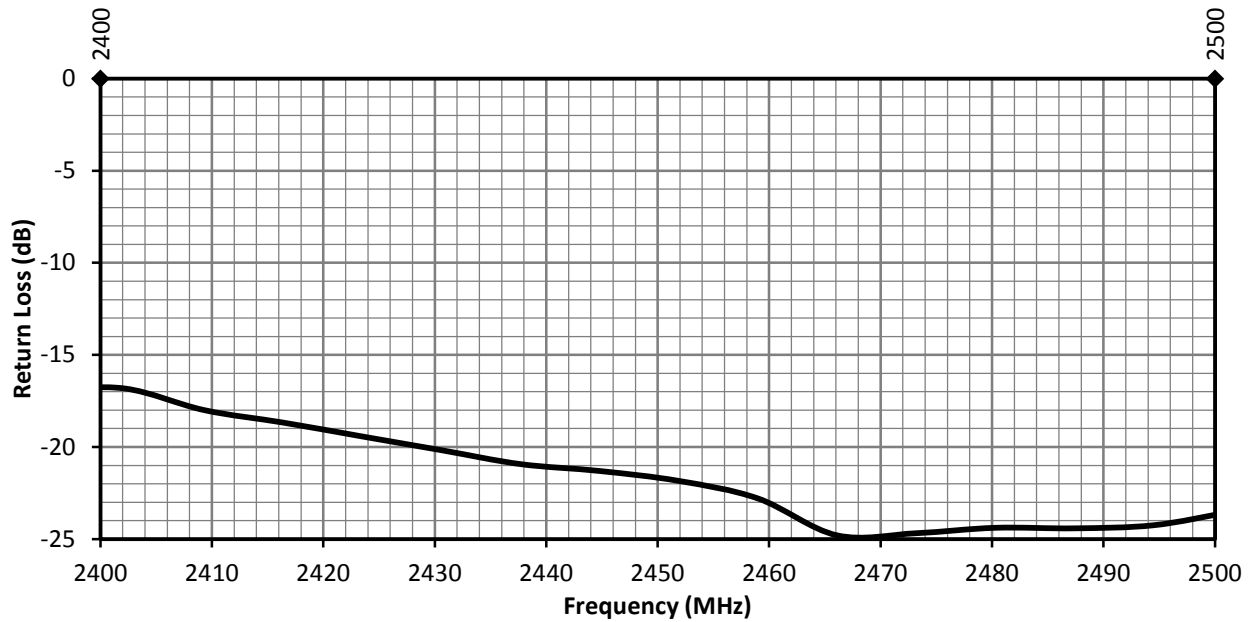

Figure 4. ANT-2.4-MSA-TH1 Return Loss

PEAK GAIN

The peak gain across the antenna bandwidth is shown in Figure 5. Peak gain represents the maximum antenna input power concentration across 3-dimensional space, and therefore peak performance at a given frequency, but does not consider any directionality in the gain pattern.

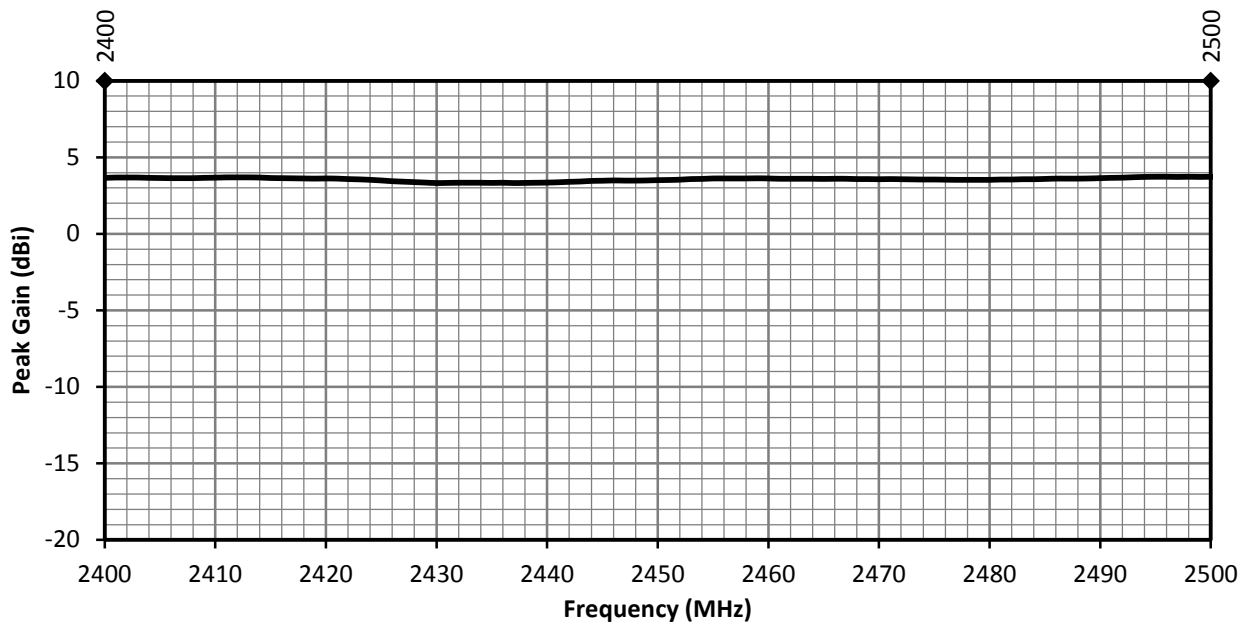

Figure 5. ANT-2.4-MSA-TH1 Antenna Peak Gain

AVERAGE GAIN

Average gain (Figure 6), is the average of all antenna gain in 3-dimensional space at each frequency, providing an indication of overall performance without expressing antenna directionality.

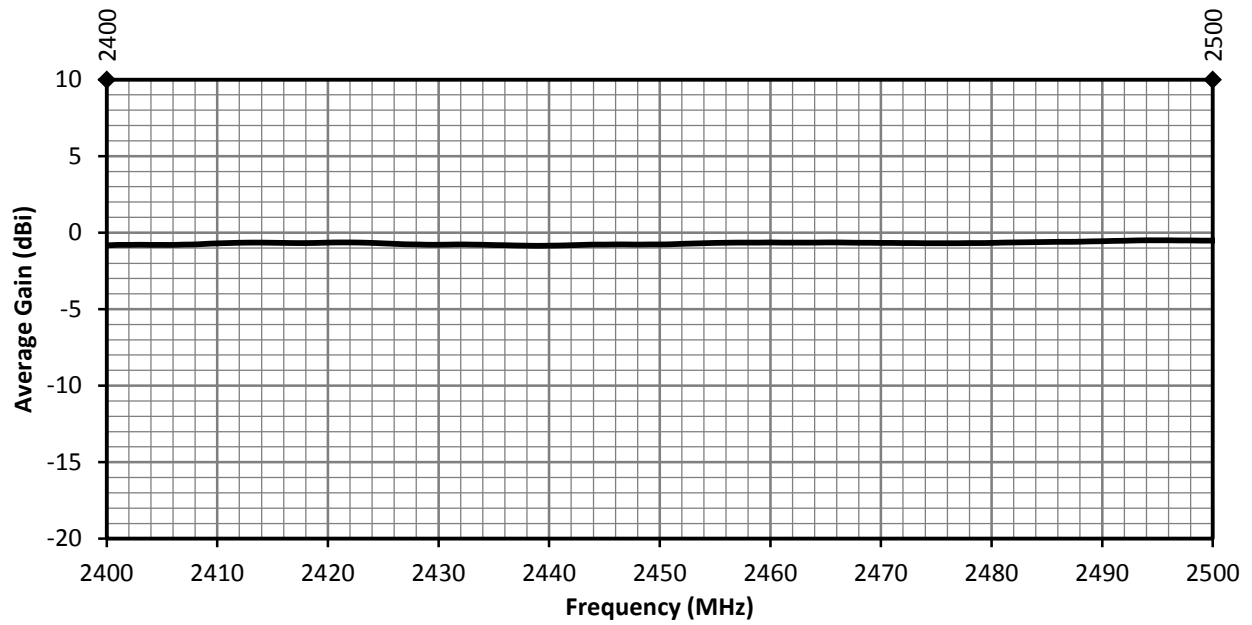

Figure 6. ANT-2.4-MSA-TH1 Average Gain

RADIATION EFFICIENCY

Radiation efficiency (Figure 7), shows the ratio of power delivered to the antenna relative to the power radiated at the antenna, expressed as a percentage, where a higher percentage indicates better performance at a given frequency.

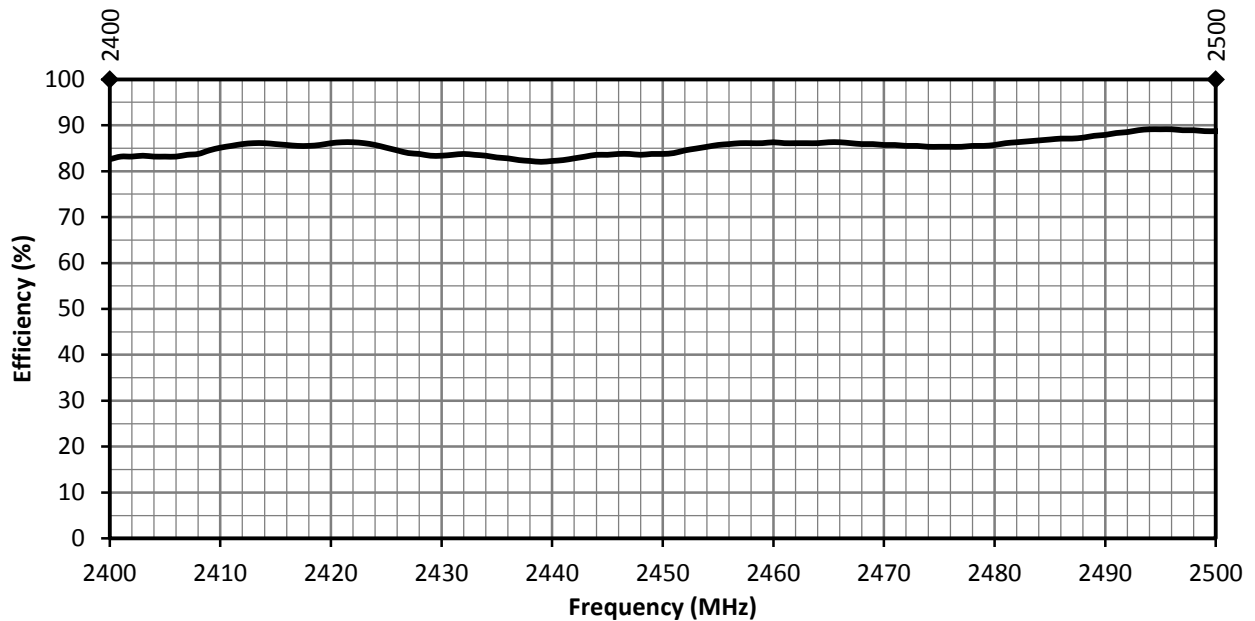
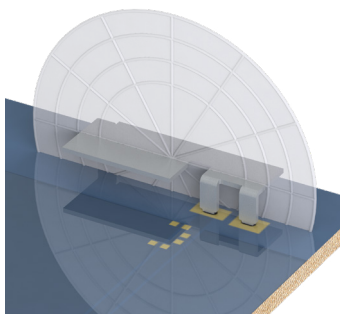

Figure 7. ANT-2.4-MSA-TH1 Radiation Efficiency

RADIATION PATTERNS

Radiation patterns provide information about the directionality and 3-dimensional gain performance of the antenna by plotting gain at specific frequencies in three orthogonal planes. Antenna radiation patterns (Figure 8), are shown using polar plots covering 360 degrees. The antenna graphic above the plots provides reference to the plane of the column of plots below it. Note: when viewed with typical PDF viewing software, zooming into radiation patterns is possible to reveal fine detail.

RADIATION PATTERNS - FREE SPACE



XZ-Plane Gain

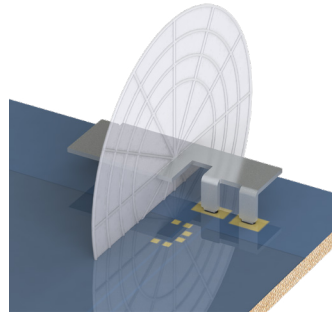

YZ-Plane Gain

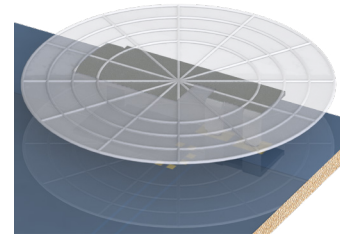

XY-Plane Gain

2.4 GHz TO 2.5 GHz (2.45 GHz)

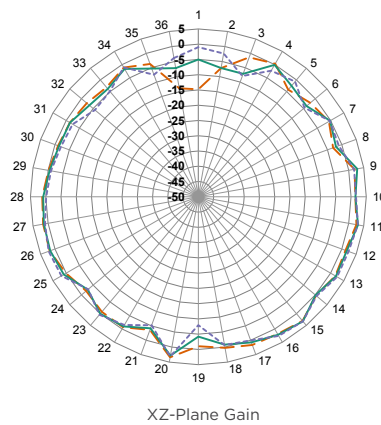

XZ-Plane Gain

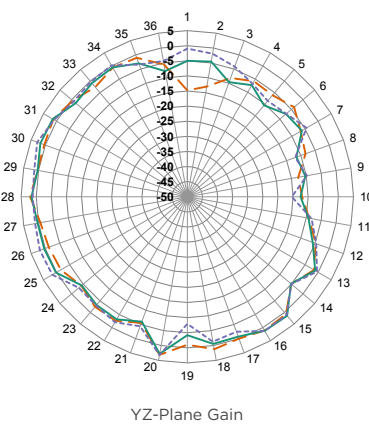

YZ-Plane Gain

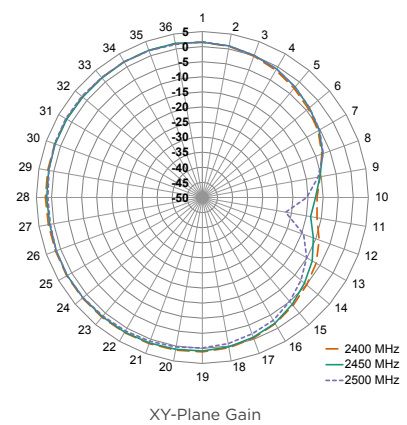

XY-Plane Gain

Figure 8. ANT-2.4-MSA-TH1 Antenna Radiation Patterns

DESIGN IMPLEMENTATION

The recommended design implementation of the ANT-2.4-MSA-TH1 includes a matching network, ground plane and PCB transmission line from the antenna to the matching network and to the radio circuitry.

GROUND PLANE

The ANT-2.4-MSA-TH1 is a 1/4-wave monopole antenna, and requires a ground plane on the PCB to which it is mounted. Linx recommends a 40 mm x 50 mm or larger ground plane. The ANT-2.4-MSA-TH1 should be mounted in relation to the edge of the ground plane as shown in Figure 10, and none of the ground plane should be underneath the antenna. Other ground plane sizes and antenna mounting locations are possible. Linx offers PCB design reviews to help optimize solution performance.

MATCHING NETWORK

Linx recommends inclusion of at least a 3-element, surface mount pi matching network of two parallel capacitors, (X1, X3) and one serial inductor, (X2) in all designs. (Figure 9) Surface mount components should be 0603 size. 0402 size components are also supported. The ANT-2.4-MSA-TH1, as designed, does not require matching, but matching may improve end-product antenna performance depending on the effects of the enclosure, PCB and other electronic components. If no matching is necessary, the serial element may be populated with a zero-ohm resistor and no components in the two capacitor positions.

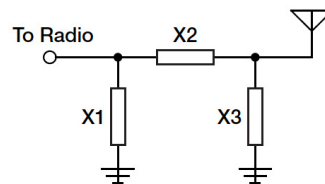

Figure 9. Matching Network Recommendation

RECOMMENDED PCB LAYOUT

Figure 10 shows the recommended printed circuit board layout for the ANT-2.4-MSA-TH1 antenna.

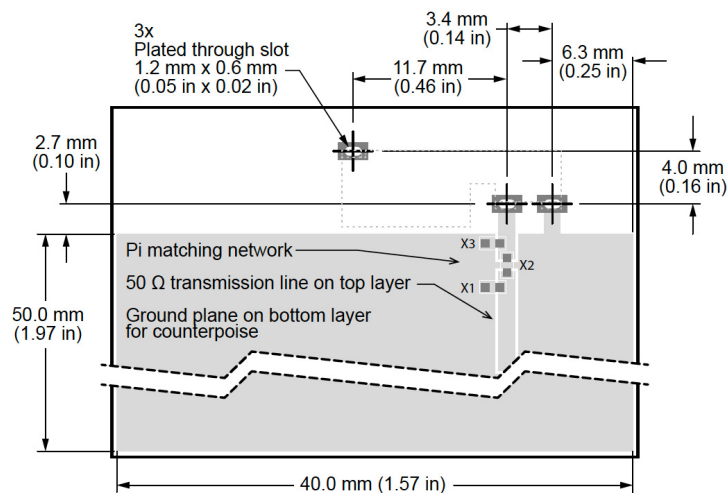

Figure 10. AmNT-e2.n4-MdSeA-dTH 1P ReCcoBmm eFndoedo Ltapyourt

TRANSMISSION LINES FOR EMBEDDED ANTENNAS

For most designs, Linx recommends a microstrip transmission line for the ANT-2.4-MSA-TH1. A microstrip transmission line is a PCB trace that runs over a ground plane to maintain the characteristic impedance for optimal signal transfer between the antenna and radio circuitry. Linx designs all antennas with a characteristic impedance of 50 Ω.

- Important practices to observe when designing a transmission line are:
- Keep all transmission lines to a minimum length for best signal performance.
- Use RF components that also operate at a 50 Ω impedance.
- If the radio is not on the same PCB as the antenna the microstrip should be terminated in a connector enabling a shielded cable to complete the antenna connection to the radio, as exemplified on the ANT-2.4-MSA-TH1 evaluation board.
- For designs subject to significant electromagnetic interference, a coplanar waveguide transmission line may be used on the PCB.

The design of a PCB transmission line can be aided by many commercially available software packages which can calculate the correct transmission line width and gap dimensions based upon the PCB thickness and dielectric constant used.

REFLOW SOLDER PROFILE

The ANT-2.4-MSA-TH1 uses a typical RoHS solder reflow profile. Refer to application note AN-00504 on the Linx website for more information.

ANTENNA DEFINITIONS AND USEFUL FORMULAS

VSWR - Voltage Standing Wave Ratio. VSWR is a unitless ratio that describes the power reflected from the antenna back to the radio. A lower VSWR value indicates better antenna performance at a given frequency. VSWR is easily derived from Return Loss.

$$VSWR = \frac{10^{\left[\frac{\text{Return Loss}}{20}\right]} + 1}{10^{\left[\frac{\text{Return Loss}}{20}\right]} - 1}$$

Return Loss - Return loss represents the loss in power at the antenna due to reflected signals, measured in decibels. A lower return loss value indicates better antenna performance at a given frequency. Return Loss is easily derived from VSWR.

$$\text{Return Loss} = -20 \log_{10} \left[\frac{VSWR - 1}{VSWR + 1} \right]$$

Efficiency (η) - The total power radiated from an antenna divided by the input power at the feed point of the antenna as a percentage.

Total Radiated Efficiency - (TRE) The total efficiency of an antenna solution comprising the radiation efficiency of the antenna and the transmitted (forward) efficiency from the transmitter.

$$TRE = \eta \cdot \left(1 - \left(\frac{VSWR - 1}{VSWR + 1} \right)^2 \right)$$

Gain - The ratio of an antenna's efficiency in a given direction (G) to the power produced by a theoretical lossless (100% efficient) isotropic antenna. The gain of an antenna is almost always expressed in decibels.

$$G_{db} = 10 \log_{10}(G)$$

$$G_{dBd} = G_{dBi} - 2.51dB$$

Peak Gain - The highest antenna gain across all directions for a given frequency range. A directional antenna will have a very high peak gain compared to average gain.

Average Gain - The average gain across all directions for a given frequency range.

Maximum Power - The maximum signal power which may be applied to an antenna feed point, typically measured in watts (W).

Reflected Power - A portion of the forward power reflected back toward the amplifier due to a mismatch at the antenna port.

$$\left(\frac{VSWR - 1}{VSWR + 1} \right)^2$$

decibel (dB) - A logarithmic unit of measure of the power of an electrical signal.

decibel isotropic (dBi) - A comparative measure in decibels between an antenna under test and an isotropic radiator.

decibel relative to a dipole (dBd) - A comparative measure in decibels between an antenna under test and an ideal half-wave dipole.

Dipole - An ideal dipole comprises a straight electrical conductor measuring $1/2$ wavelength from end to end connected at the center to a feed point for the radio.

Isotropic Radiator - A theoretical antenna which radiates energy equally in all directions as a perfect sphere.

Omnidirectional - Term describing an antenna radiation pattern that is uniform in all directions. An isotropic antenna is the theoretical perfect omnidirectional antenna. An ideal dipole antenna has a donut shaped radiation pattern and other practical antenna implementations will have less perfect but generally omnidirectional radiation patterns which are typically plotted on three axes.

RADIATION PATTERNS

Radiation patterns provide information about the directionality and 3-dimensional gain performance of the antenna by plotting gain at specific frequencies in three orthogonal planes. Antenna radiation patterns are shown in Figure 17 using polar plots covering 360 degrees. The antenna graphic at the top of the page provides reference to the plane of the column of plots below it. Note: when viewed with typical PDF viewing software, zooming into radiation patterns is possible to reveal fine detail.

RADIATION PATTERNS - CENTER OF GROUND PLANE

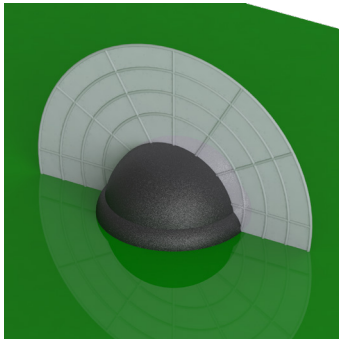

XZ-Plane Gain

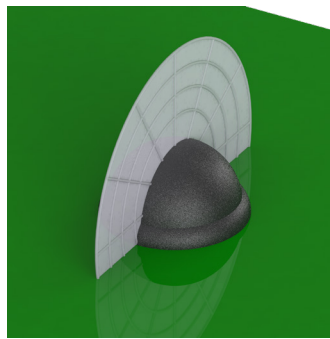

YZ-Plane Gain

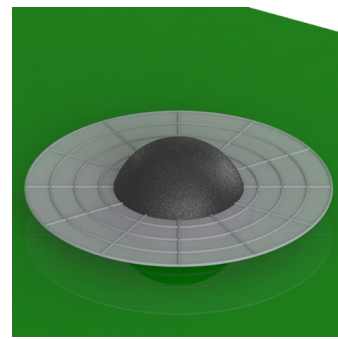

XY-Plane Gain

2400 MHz TO 2500 MHz (2450 MHz)

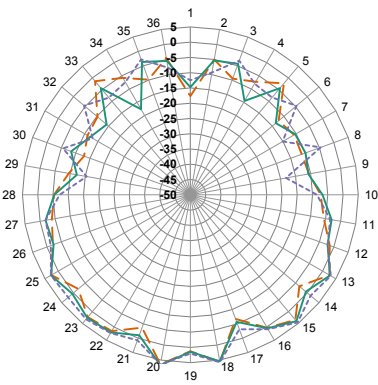

XZ-Plane Gain

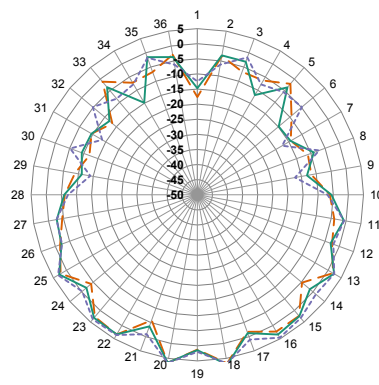

YZ-Plane Gain

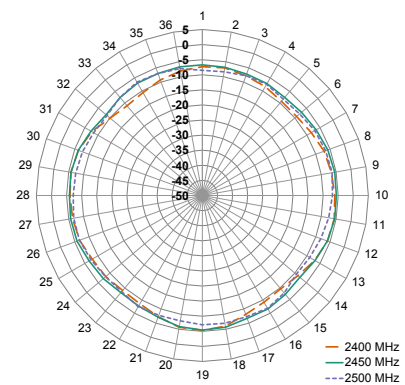

XY-Plane Gain

Figure 17. ANT-410-WRT Radiation Patterns, Center of Ground Plane

TE TECHNICAL SUPPORT CENTER

USA:	+1 (800) 522-6752
Canada:	+1 (905) 475-6222
Mexico:	+52 (0) 55-1106-0800
Latin/S. America:	+54 (0) 11-4733-2200
Germany:	+49 (0) 6251-133-1999
UK:	+44 (0) 800-267666
France:	+33 (0) 1-3420-8686
Netherlands:	+31 (0) 73-6246-999
China:	+86 (0) 400-820-6015

te.com

TE Connectivity, TE, TE connectivity (logo), Linx and Linx Technologies are trademarks owned or licensed by the TE Connectivity Ltd. family of companies. All other logos, products and/or company names referred to herein might be trademarks of their respective owners.

The information given herein, including drawings, illustrations and schematics which are intended for illustration purposes only, is believed to be reliable. However, TE Connectivity makes no warranties as to its accuracy or completeness and disclaims any liability in connection with its use. TE Connectivity's obligations shall only be as set forth in TE Connectivity's Standard Terms and Conditions of Sale for this product and in no case will TE Connectivity be liable for any incidental, indirect or consequential damages arising out of the sale, resale, use or misuse of the product. Users of TE Connectivity products should make their own evaluation to determine the suitability of each such product for the specific application.

TE Connectivity warrants to the original end user customer of its products that its products are free from defects in material and workmanship. Subject to conditions and limitations TE Connectivity will, at its option, either repair or replace any part of its products that prove defective because of improper workmanship or materials. This limited warranty is in force for the useful lifetime of the original end product into which the TE Connectivity product is installed. Useful lifetime of the original end product may vary but is not warranted to exceed one (1) year from the original date of the end product purchase.

©2022 TE Connectivity. All Rights Reserved.

10/22 Original