

CROWN LINE Power Bus Bar Distribution System

The pluggable bus bar system

Technical Data

Product Facts

- Currents up to 300 Amps
- Up to 2 meters in length
- Pluggable breakers
- VDE finger proof
- Flammability UL 94 V-0
- Easily configurable
- Adaptable
- Space efficient
- Reduced installation costs
- Left and right handed configurations available
- Polarized connector fitting
- UL508 recognized

Applications

- Power distribution
- Core network equipment
- Cellular base stations
- Servers, storage & network
- Routers
- Industrial

Technical Features

Product Specification : 108-19299

Application Specification : 114-19108



UL File No. E164323



The CROWN LINE power bus bar system is designed for cost effective power distribution in equipment cabinets, telecom base stations, computer servers, storage systems and industrial applications.

The unique finger design gives repeatable low impedance electrical performance, helps reduce assembly time and wiring errors with pre-determined input/output connections. System thermal characteristics are improved with the use of flat copper conductors allowing better heat dissipation compared to conventional use of large AWG cables.

The CROWN LINE system consists of an insulating housing which holds two solid copper conductors. Power is supplied to conductors from a regulated power source using flexible power cables and color coded RAPID LOCK and/or M10 ring tongue terminals. The CROWN LINE power bus bar provides a flexible and adaptable design, up to 2 meters in length, with the ability to pre-form conductors to fit into awkward spaces.

Power input and output connectors uses the proven CROWN BAND, and CROWN CLIP contact interfaces for reliable, low loss connections. An alternate threaded/bolted input connection is also available. A connector with an installed circuit breaker, can be mated direct to the CROWN LINE Power bus bar at any location along its length. The Circuit Breaker Connector (CBC) accepts TE's POTTER & BRUMFIELD circuit breakers with tab terminals to connect to Positive Lock output connectors. A cable assembly connects from the CBC to deliver power where needed. With this design, each power tap has overload protection and can easily and conveniently be turned on or off to provide a safe installation or removal of sensitive electric equipment.

Bus Bar Options : RAPID LOCK Connectors

Technical Data

Product Facts

- Currents up to 300 Amps
- Alternative to threaded/bolted connections
- Locking feature "snaps" each contact to mating pin
- Up to 300 Amps per contact
- CROWN BAND connector technology provides low contact resistance
- UL508 recognized

Typical Applications

- Power distribution systems
- Recognized under the component program of Underwriters laboratories



UL File No. E164323



Note : Image shows left hand cable exit product

The RAPID LOCK connector is a single-pole, quick connect/disconnect replacement for bolted connections. RAPID LOCK connector input power terminals provide a quicker, easier installation over threaded/bolted connections. The cable mounted sockets have a right-angle configuration, for easy routing from the bus bar. The mating pin contacts are pre-assembled to the bus bar.

Secure Power Distribution

By replacing power lugs fitted using nuts and bolts, the RAPID LOCK connector offers a secure interconnect mechanism that helps prevent the power distribution system from the risk of loose connections.

Safety Locking Feature

A locking feature is provided on the pins for protection against accidental unlatching of the cable. Although connection of the cable is easily performed by hand, disconnection requires a simple tool to provide the leverage needed to overcome the locking feature. Improved Ease of Service in the field becomes very easy with RAPID LOCK connectors because there are no nuts and washers to lose in the equipment. The RAPID LOCK connector is available with red or black color insulators. The RAPID LOCK connector enjoys all the benefits of the Tyco Electronics CROWN BAND product technology, providing a stable connection with excellent mechanical and electrical performance with ratings up to 300 Amps depending on wire gauge and application.

CROWN BAND

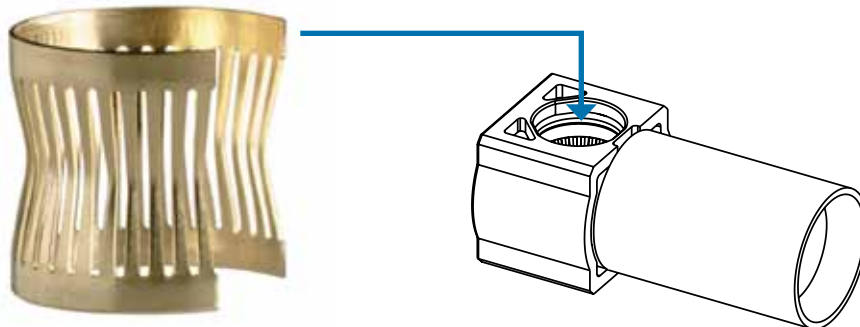

Bus Bar Options : RAPID LOCK Connectors

Technical Data

Product Facts

- Currents up to 300 A
- Current rating up to 300 Amps
- Up to 3/0 (95 mm²) cable
- VDE Finger Proof
- Flammability UL 94 V-0
- UL508 recognized

Materials and Plating

Conductor : Copper
 Plating : Nickel
 Insulator : Polycarbonate
 Temperature Range : -40 °C to +125 °C
 Length : Variable up to 200 cm



UL File No. E164323

RAPID LOCK Bus Bar Selection

Left Hand Cable Exit Part Number	Right Hand Cable Exit Part Number	Total Bus Bar Length*	Effective Bus Bar Length*
1857561-1	1857561-2	1920	1800
1857561-5	1857561-6	620	500
1857561-7	1857561-8	1120	1000
1857561-9	1-1857561-0	1620	1500
1-1857561-1	1-1857561-2	2120	2000
1-1857561-3	1-1857561-4	2370	2250
1-1857561-5	1-1857561-6	900	780
1-1857561-7	1-1857561-8	1800	1680

*Less space required for input connections
 Drawing Number : 1857561

RAPID LOCK Terminals

Color	Part Number	Wire Size
RED	1857547-1	80-90 mm ² (3/0 AWG)
BLUE	1857547-2	80-90 mm ² (3/0 AWG)

Note : One red and one blue terminal is required to match CROWN LINE terminals

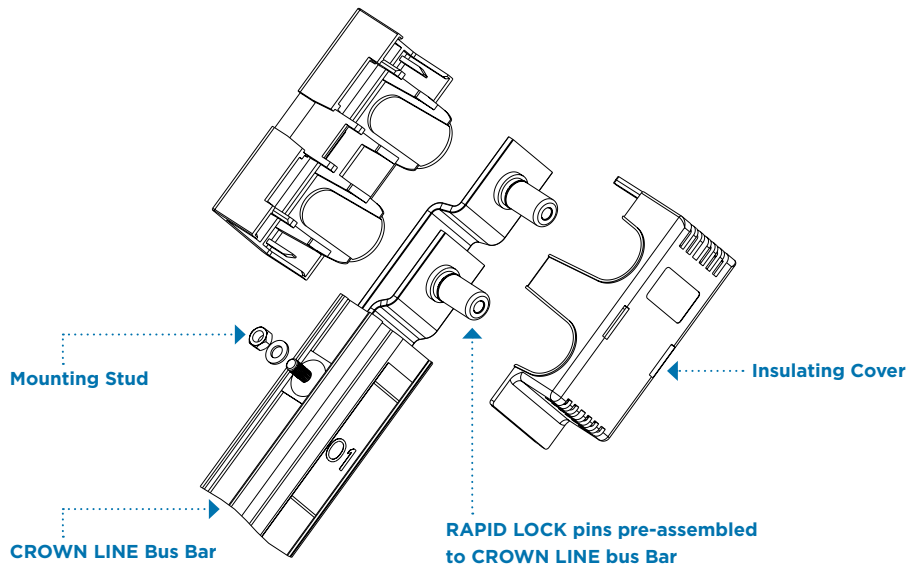

Bus Bar Options : Threaded/Bolted Connection

Technical Data

Product Facts

- Current rating up to 300 Amps
- Up to 95 mm² cable
- VDE finger proof
- Flammability UL 94 V-0
- UL508 recognized

Materials and Plating

Conductor : Copper
 Plating : Nickel
 Insulator : Polycarbonate
 Temperature Range : -40 °C to +125 °C
 Length : Variable up to 200 cm/2 meters



UL File No. E164323

M10 Ring Tongue Bus Bar Selection

Left Hand Cable Exit Part Number	Right Hand Cable Exit Part Number	Total Bus Bar Length*	Effective Bus Bar Length*
1551683-1	1551683-2	1920	1800
1551683-5	1551683-6	620	500
1551683-7	1551683-8	1120	1000
1551683-9	1-1551683-0	1620	1500
1-1551683-1	1-1551683-2	2120	2000
1-1551683-3	1-1551683-4	2370	2250
1-1551683-5	1-1551683-6	900	780
1-1551683-7	1-1551683-8	1800	1680

*Less space required for input connections
 Drawing number : 1551683

M10 Ring Tongue Terminals

Part Number	Wire Size
709819-3	80-90 mm ² (3/0 AWG)
710025-5	50 mm ² (1/0 AWG)

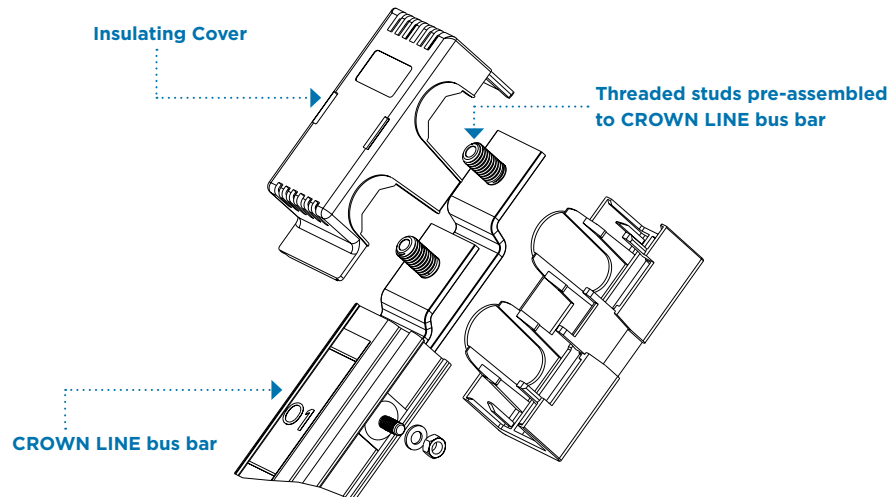

Output Connectors : Positive Lock Connector

Technical Data

Product Facts

- Connects onto tabs containing holes.
- Reduced insertion force.
- Housing insulates and serves as removal tool.
- Mechanical “snap” when receptacles are mated
- Low removal force by pulling on housing to remove

Materials and Finish

Contacts : Tin plated brass

Housings : Polyamide, UL 94 V0

Performance Data

Current Carrying Capacity : Up to 25 Amps

Technical Documents

Application Specifications :

114-2153 Positive Lock



Positive Lock Connector Part Numbers

Part Number	Description	Color
1969364-1	Housing, 2 position, H-Type	Natural

Note: housing accomodates wire size 4 to 6mm² (12 to 10 AWG)



UL File No. E28476 and E66717



CSA File No. LR7189A

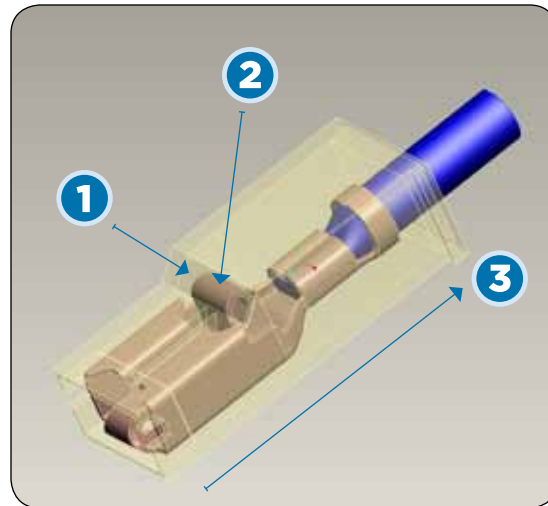

1 : Actuation ramp

2 : Latch release

3 : Direction of pull

Output Connectors : Circuit Breaker Connector

Technical Data

Product Facts

- Squeeze to Release Latch
- Power Rating up to 30 Amps
- Polarized Connection to Bus Bar
- Accepts TE W6/W9 Circuit Breakers
- High Current Bus Bar Contacts
- Low Insertion Force
- Easy Installation
- UL508 recognized

Materials and Plating

Main contact : Copper alloy, Gold plated

Tabs : Brass, Tin plated

Tab adaptors : Brass, Tin plated

Housing : PC, black, UL 94 V0

Nuts & Bolts : Steel, Zinc plated

Bush : Brass

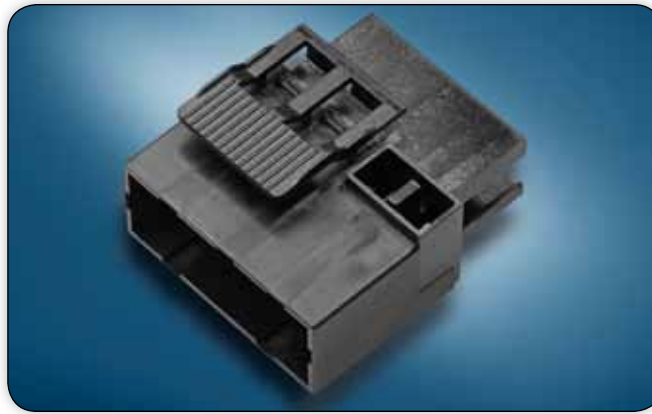

Ordering Part Number

Part Number	Description
1857147-1	Breaker connector assembly

Power Distribution Ordering Information

Effective Bus Bar Length	Max. number Output Connections
620	8
900	12
1120	16
1800	28
1920	30
2120	34
1620	35
2370	38



UL File No. E164323

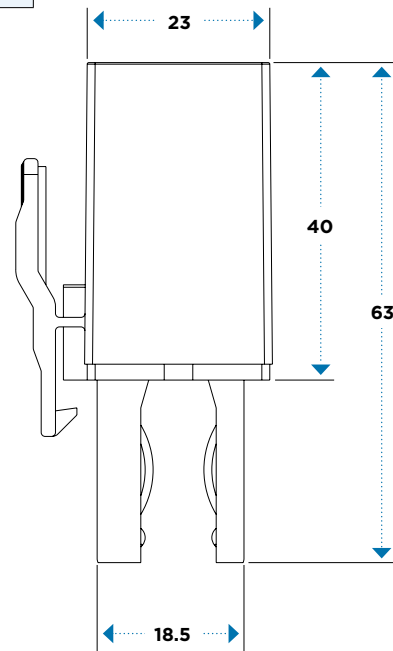
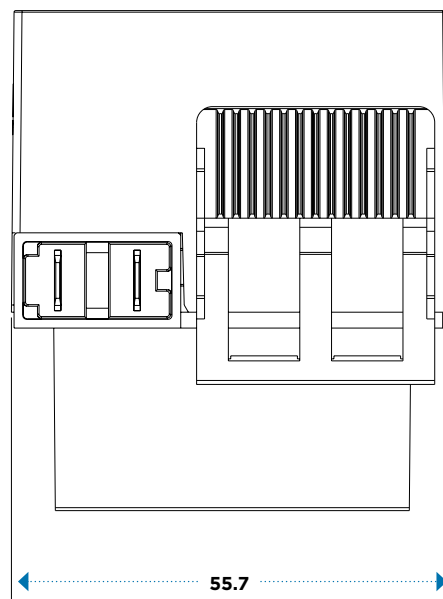

Output Connectors : General Purpose Circuit Breaker : W6

Technical Data

Product Facts

- Secondary protection, heavy duty magnetic hydraulic for the international market
- Optional toggle guard available
- UL1077 and UL1500 recognized

Materials and Finish

Ambient Temperature : -40°C to +85°C
 Terminal Type : Quick connect, screw and stud
 Manual Operation : Actuator, toggle and rocker

Contact Data

Contact Type : Magnetic/Hydraulic
 Contact Arrangement : Number of poles 1-4
 Circuit Function : Series trip
 Rated Current : 0.20 Amps - 50 Amps

Insulation Data

Initial dielectric strength : No extra line, in one set with next lines (except cb), 50/60Hz, 1500V, DC 1100V
 Approvals : UL1077, UL1500, CSA, VDE



UL File No. E69543



CSA File No. LR15734



VDE 0642/EN60934
 License No. 73782



Circuit Breakers : Ordering Part Numbers

TE Part Number	TE Descriptive Part Number	Description	AMPS	POLE	Maximum Line Voltage
8-1393252-5	W67-X1063-25	Magnetic hydraulic secondary protection, standard delay curve, quick connect termination	25	One pole series trip	65VDC
8-1393252-4	W67-X1063-20	Magnetic hydraulic secondary protection, standard delay curve, quick connect termination	20	One pole series trip	65VDC
8-1393252-2	W67-X1063-15	Magnetic hydraulic secondary protection, standard delay curve, quick connect termination	15	One pole series trip	65VDC
8-1393252-1	W67-X1063-10	Magnetic hydraulic secondary protection, standard delay curve, quick connect termination	10	One pole series trip	65VDC

Technical Data

Test Results

Visual

Test Title	Performance/Severity Requirements	Procedure
Examination of Product	Meets applicable requirements specified on customer drawing, application specification and packaging specification	Visual, dimensional and functional per applicable inspection plan. In accordance with IEC 60512-1-1 Magnification 10x

Electrical

Test Title	Performance/Severity Requirements	Procedure
Milivolt drop CBC bus bar	400 mV max. at test current 30 Amps	In accordance with IEC 60512-2-2
Milivolt drop RAPID LOCK connector	20 mV max. at test current 250 Amps	In accordance with IEC 60512-2-2
Milivolt drop bus bar system	500 mV max. at test current 30 Amps	In accordance with IEC 60512-2-2
Insulation resistance	Test voltage 100 V DC, mated. Duration : 1 minute Requirement : 10mff min	In accordance with IEC 60512-3-1
Voltage proof	Test voltage 500 V AC, mated. Duration : 1 minute Requirement : No break-down or flash-over	In accordance with IEC 60512-4-1
Current/temperature derating RAPID LOCK connector	See figure 2a	In accordance with IEC 60512-5-2
Current/temperature derating CBC bus bar	See figure 2b	In accordance with IEC 60512-5-2

Figure 2a : RAPID LOCK Connector Derating Curve

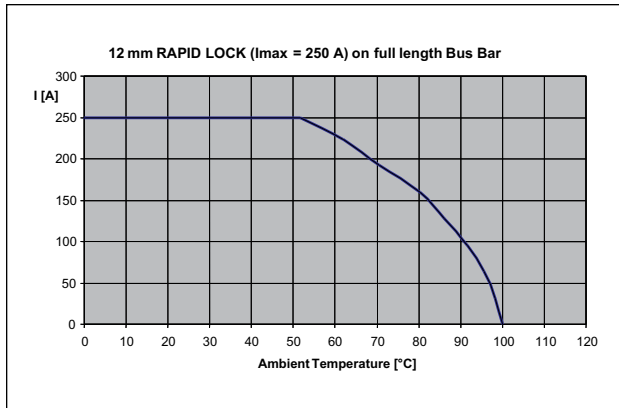
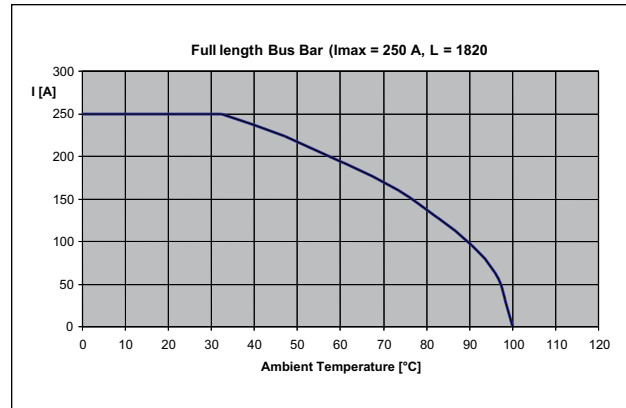

Figure 2b : Bus Bar Derating Curve



Technical Data

Test Results

Mechanical

Test Title	Performance/Severity Requirements	Procedure
Breaker mating/unmating force	Mated and unmate breaker 10 cycles Requirement : Mating force 80 N Max.	Force definition curve IEC 60512-13-2
CBC latch hold force	Pull CBC perpendicular form bus bar without pressing the latch Requirements : Force to disengage is min. 2 times breaker unmating force.	Force definition curve
Mechanical operation CBC	Mate and unmate CBC with bus bar Operation cycles : 30 Speed : 10 mm/s	In accordance with IEC 60512-9-1
Mechanical operation RAPID LOCK connector	Mate and unmate with bus bar pin. Operation cycles : 10 Speed : 10 mm/s	In accordance with IEC 60512-9-1
CBC main contact retention in housing	30 N min. retention force per contact	In accordance with IEC 60512-15-1

Environmental

Test Title	Performance/Severity Requirements	Procedure
Temperature cycling	-25°C/85°C, 0.5 hrs/0.5 hrs 5 cycles (mated)	In accordance with IEC 60512-11-4
Low temperature	Temperature : -55°C Duration : 2 hrs Requirement : No functional damage	In accordance with IEC 60512-11-10
Dry heat	Temperature : +85°C Duration : 16 hrs. (mated)	In accordance with IEC 60512-11-9
Damp/heat steady state	Temperature : -40°C, RH : 93% Duration : 500 hrs Requirement : No functional damage	In accordance with IEC 60512-11-3
Corrosion industrial atmosphere	500 ppb SO ₂ /100 ppb H ₂ S 4 days (unmated)	In accordance with IEC 60068-2-60, Ke

Figure 2c : Circuit Breaker Connector (CBC) Derating Curve

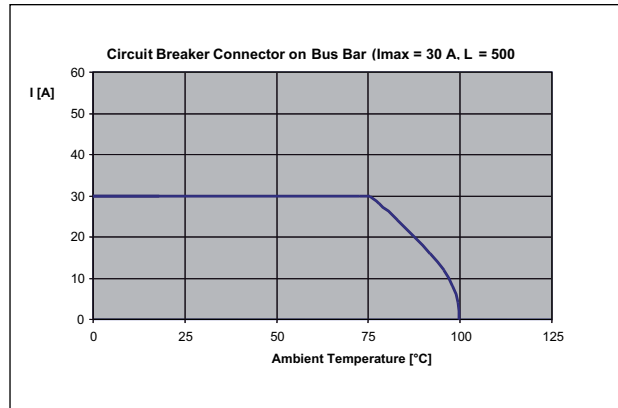

FOR MORE INFORMATION

te.com/products/crownline

TE Technical Support Center

USA:	+1 (800) 522-6752
Canada:	+1 (905) 475-6222
Mexico/C. America:	+52 (0) 55-1106-0800
Latin/S. America:	+54 (0) 11-4733-2200
Germany:	+49 (0) 6251-133-1999
UK:	+44 (0) 800-267666
France:	+33 (0) 1-3420-8686
Netherlands:	+31 (0) 73-6246-999
China:	+86 (0) 400-820-6015

Part numbers in this brochure are RoHS Compliant*, unless marked otherwise.

*as defined www.tycoelectronics.com/leadfree



te.com

© 2011 Tyco Electronics Corporation, a TE Connectivity Ltd. Company. All Rights Reserved.

1654261-2 CIS 10/2011

CROWN BAND, CROWN CLIP, CROWN LINE, POSITIVE LOCK, POTTER & BRUMFIELD, RAPID LOCK, TE Connectivity, the TE connectivity (logo) are trademarks. Other logos, product and/or company names might be trademarks of their respective owners

While TE has made every reasonable effort to ensure the accuracy of the information in this brochure, TE does not guarantee that it is error-free, nor does TE make any other representation, warranty or guarantee that the information is accurate, correct, reliable or current. TE reserves the right to make any adjustments to the information contained herein at any time without notice. TE expressly disclaims all implied warranties regarding the information contained herein, including, but not limited to, any implied warranties of merchantability or fitness for a particular purpose. The dimensions in this catalog are for reference purposes only and are subject to change without notice. Specifications are subject to change without notice. Consult TE for the latest dimensions and design specifications.

