



Sliver Cable Assemblies

TABLE OF CONTENTS

Introduction..... 2

 Description..... 2

 Features and Benefits 2

 Product Applications 2

 Industry Standards..... 2

 Technical Documents..... 2

Part Numbers 3

 Table 1. Part Number Selection Guide 3

Product Specifications 3

 Table 2. Material Specifications..... 3

 Table 3. Electrical/Mechanical Specifications – Discrete Primary Pair Cable Assembly..... 4

 Table 4. Electrical/Mechanical Specifications – Laminated Ribbon Cable Assembly 4

 Table 5. Environmental Specifications..... 4

 Table 6. Discrete Primary Pair Cable Specifications..... 5

 Table 7. Laminated Ribbon Cable Specifications..... 5

Pin Configurations 6

 Sliver 50 Position 6

 Sliver 74 Position 7

Sliver Cable Assembly Mechanical Schematics 8

 Sliver 50 Position Straight Cable Assembly..... 8

 Sliver 74 Position Straight Cable Assembly..... 8

 Sliver 50 Position Right Angle Cable Assembly..... 9

 Sliver 74 Position Right Angle Cable Assembly..... 9

Signal Integrity Performance..... 10

Sliver Cable Assemblies

INTRODUCTION

Description

TE Connectivity's (TE) Sliver passive copper cable assembly is a robust and flexible cabling solution for internal interconnects. Due to the lower loss characteristics of copper cable, Sliver cabling reduces overall power requirements and extends the reach for high data rate signals inside networking equipment. TE's Sliver cable solution lowers overall costs by eliminating re-timers required to compensate for lossy PCB traces as well as more costly, lower loss PCB laminates.

Sliver cable assemblies are offered in fine gage 33AWG low loss primary pairs and flat ribbon cable. The Sliver connector design is scalable in 4x increments and is available in straight and right angle plug configurations to mate with right angle and vertical board mount connectors. These connector styles offer a broad range of cable to board mating flexibility.

Sliver cables are designed for applications in the data center, networking and telecommunications markets that use Ethernet, PCIe, InfiniBand, SAS and other signal protocols. Sliver cables and connectors are compatible with all types and speeds of microprocessors, and enable many interconnection configurations such as chip-to-chip, chip-to-front/rear panel, chip-to-backplane and a vertical card edge option.

Features and Benefits

- Compatible with many different industry standards and protocols
- Supports speeds from 12G to 25Gbps per channel
- Enables less expensive PCB material and electronics, with higher channel performance
- Optimized construction to minimize insertion loss and cross talk
- Supports all types and speeds of microprocessors
- High density 0.6mm contact pitch
- Connector designed to be scalable from 4x to 20x
- Active press to release stainless steel latch
- 33AWG low loss 25GHz primary pairs or 12GHz flat ribbon cable
- RoHS compliant

Product Applications

- Switches, servers and routers
- Data Center networks
- Storage area networks
- High performance computing
- Telecommunication and wireless infrastructure

Industry Standards

- 10G / 25G Ethernet
- PCIe Gen 3 / Gen 4
- QPI - Intel QuickPath Interconnect
- SAS 3.0 / 4.0
- InfiniBand QDR / FDR / EDR
- SATA

Technical Documents

Product Specification

108-32115 Sliver Cable Assembly

Sliver Cable Assemblies

PART NUMBERS

Table 1. Part Number Selection Guide

Part Description	Data Rate	Impedance	Bulk Cable	50 position		74 position	
				0.5 Meter	1 Meter	0.5 Meter	1 Meter
Straight Cable Plugs	25G	85	Discrete pairs	2821742-1	2821742-2	2821376-1	2821376-2
Right Angle Cable Plugs	25G	85	Discrete pairs	2821743-1	2821743-2	2821745-1	2821745-2
Straight-to-Right Angle Plugs	25G	85	Discrete pairs	2821744-1	2821744-2	2821746-1	2821746-2
Straight Cable Plugs	25G	100	Discrete pairs	2821750-1	2821750-2	2821756-1	2821756-2
Right Angle Cable Plugs	25G	100	Discrete pairs	2821751-1	2821751-2	2821757-1	2821757-2
Straight-to-Right Angle Plugs	25G	100	Discrete pairs	2821752-1	2821752-2	2821758-1	2821758-2
Straight Cable Plugs	12G	85	Ribbon	2820397-1	2820397-2	2820396-1	2820396-2
Right Angle Cable Plugs	12G	85	Ribbon	2820399-1	2820399-2	2821385-1	2821385-2
Straight-to-Right Angle Plugs	12G	85	Ribbon	2821638-1	2821638-2	2821639-1	2821639-2
Straight Cable Plugs	12G	100	Ribbon	2821747-1	2821747-2	2821753-1	2821753-2
Right Angle Cable Plugs	12G	100	Ribbon	2821748-1	2821748-2	2821754-1	2821754-2
Straight-to-Right Angle Plugs	12G	100	Ribbon	2821749-1	2821749-2	2821755-1	2821755-2

*Discrete pairs are optional for 12G platform
Contact TE for customized lengths

PRODUCT SPECIFICATIONS

Table 2. Material Specifications

PCB	Halogen Free low loss laminate
	IPC Class 3
Contact	30µin min hard Gold plated contact pads
Connector housing	Polycarbonate (Lexan)
Active latch	Stainless steel
Discrete Cable	Silver plated copper conductor
	Fluoropolymer dielectric
	Metallic tape pair shield
	Polyester tape jacket
Laminated Cable	Silver plated copper conductor
	Tinned copper drain wire
	Al-mylar pair shield
	PET Outer Wrapping

Sliver Cable Assemblies

Table 3. Electrical/Mechanical Specifications – Discrete Primary Pair Cable Assembly

Impedance	100Ω
	85Ω
Data Rate	25Gbps per channel
Within Pair Skew	100 ohm = 7 ps/m
	85 ohm = 10 ps/m
Rated Voltage	30V
Rated Current	0.5A per pin
Durability	250 mating cycles
Mating Force	50 pos = 10N
	74 pos = 15N

Table 4. Electrical/Mechanical Specifications – Laminated Ribbon Cable Assembly

Impedance	100Ω
	85Ω
Data Rate	12Gbps per channel
Within Pair Skew	10ps/m
Rated Voltage	30V
Rated Current	0.5A per pin
Durability	250 mating cycles
Mating Force	50 pos = 10N
	74 pos = 15N

Table 5. Environmental Specifications

Storage Temperature	-40° to 80°C
Operating Temperature	0° to 80°C
Flammability Rating	CL2 (Discrete Pair)
	VW-1 (Ribbon Cable)
Safety Certificates	RoHS compliant

Sliver Cable Assemblies

Table 6. Discrete Primary Pair Cable Specifications

Bend Radius	4.5mm (good way bend)
Cable Dimensions 33AWG 85Ω	Thickness = .64 mm
	Width per pair = 1.09 mm
Attenuation 33AWG 85Ω	5 GHz = 5.2 dB/m
	12.89 GHz = 8.6 dB/m
	20 GHz = 11.4 dB/m
	25 GHz = 13.8 dB/m
Cable Dimensions 33AWG 100Ω	Thickness = .71 mm
	Width per pair = 1.24 mm
Attenuation 33AWG 100Ω	5 GHz = 4.3 dB/m
	12.89 GHz = 7.4 dB/m
	20 GHz = 9.9 dB/m
	25 GHz = 11.9 dB/m

Table 7. Laminated Ribbon Cable Specifications

Bend Radius	3mm
Cable Dimensions 33AWG 85Ω	Thickness = 0.65 mm
	Width 8 pair = 13.97mm
	Width 12 pair = 21.17mm
Attenuation 33AWG 85Ω	5 GHz = 5.4dB/m
	7 GHz = 6.7dB/m
	10 GHz = 9.1dB/m
Cable Dimensions 33AWG 100Ω	Thickness = 0.75 mm
	Width 8 pair = 13.97mm
	Width 12 pair = 21.17mm
Attenuation 33AWG 100Ω	5 GHz = 5.4dB/m
	7 GHz = 6.7dB/m
	10 GHz = 9.1dB/m

Sliver Cable Assemblies

PIN CONFIGURATIONS

Sliver 50 Position

	P1		P2
	1	GND	25
PAIR 1	2	↔	24
	3	↔	23
	4	GND	22
PAIR 2	5	↔	21
	6	↔	20
	7	GND	19
PAIR 3	8	↔	18
	9	↔	17
	10	GND	16
PAIR 4	11	↔	15
	12	↔	14
	13	GND	13
PAIR 5	14	↔	12
	15	↔	11
	16	GND	10
PAIR 6	17	↔	9
	18	↔	8
	19	GND	7
PAIR 7	20	↔	6
	21	↔	5
	22	GND	4
PAIR 8	23	↔	3
	24	↔	2
	25	GND	1

	P1		P2
	26	GND	50
PAIR 9	27	↔	49
	28	↔	48
	29	GND	47
PAIR 10	30	↔	46
	31	↔	45
	32	GND	44
PAIR 11	33	↔	43
	34	↔	42
	35	GND	41
PAIR 12	36	↔	40
	37	↔	39
	38	GND	38
PAIR 13	39	↔	37
	40	↔	36
	41	GND	35
PAIR 14	42	↔	34
	43	↔	33
	44	GND	32
PAIR 15	45	↔	31
	46	↔	30
	47	GND	29
PAIR 16	48	↔	28
	49	↔	27
	50	GND	26

Sliver Cable Assemblies

Sliver 74 Position

	P1		P2
	1	GND	37
PAIR 1	2	↔	36
	3	↔	35
	4	GND	34
PAIR 2	5	↔	33
	6	↔	32
	7	GND	31
PAIR 3	8	↔	30
	9	↔	29
	10	GND	28
PAIR 4	11	↔	27
	12	↔	26
	13	GND	25
PAIR 5	14	↔	24
	15	↔	23
	16	GND	22
PAIR 6	17	↔	21
	18	↔	20
	19	GND	19
PAIR 7	20	↔	18
	21	↔	17
	22	GND	16
PAIR 8	23	↔	15
	24	↔	14
	25	GND	13
PAIR 9	26	↔	12
	27	↔	11
	28	GND	10
PAIR 10	29	↔	9
	30	↔	8
	31	GND	7
PAIR 11	32	↔	6
	33	↔	5
	34	GND	4
PAIR 12	35	↔	3
	36	↔	2
	37	GND	1

	P1		P2
	38	GND	74
PAIR 13	39	↔	73
	40	↔	72
	41	GND	71
PAIR 14	42	↔	70
	43	↔	69
	44	GND	68
PAIR 15	45	↔	67
	46	↔	66
	47	GND	65
PAIR 16	48	↔	64
	49	↔	63
	50	GND	62
PAIR 17	51	↔	61
	52	↔	60
	53	GND	59
PAIR 18	54	↔	58
	55	↔	57
	56	GND	56
PAIR 19	57	↔	55
	58	↔	54
	59	GND	53
PAIR 20	60	↔	52
	61	↔	51
	62	GND	50
PAIR 21	63	↔	49
	64	↔	48
	65	GND	47
PAIR 22	66	↔	46
	67	↔	45
	68	GND	44
PAIR 23	69	↔	43
	70	↔	42
	71	GND	41
PAIR 24	72	↔	40
	73	↔	39
	74	GND	38

Sliver Cable Assemblies

SLIVER CABLE ASSEMBLY MECHANICAL SCHEMATICS

Sliver 50 Position Straight Cable Assembly

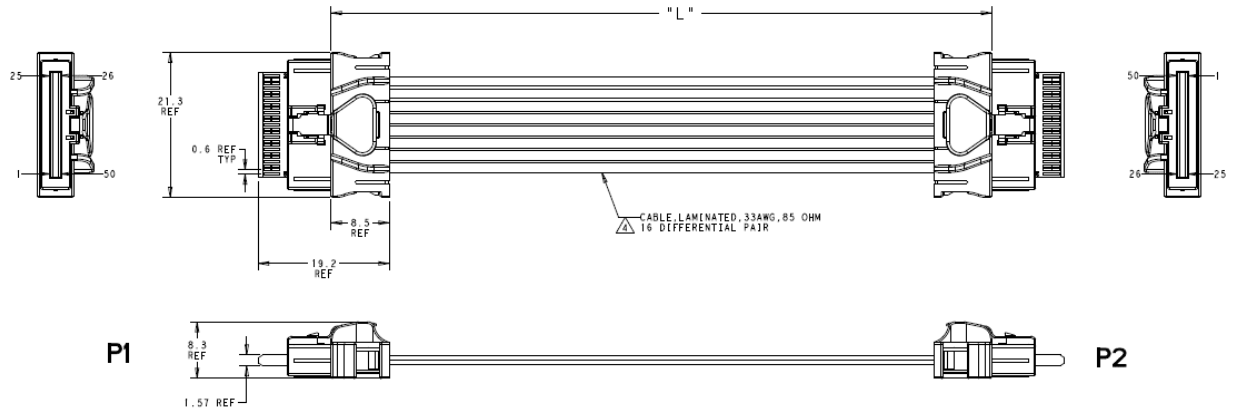

Sliver 74 Position Straight Cable Assembly

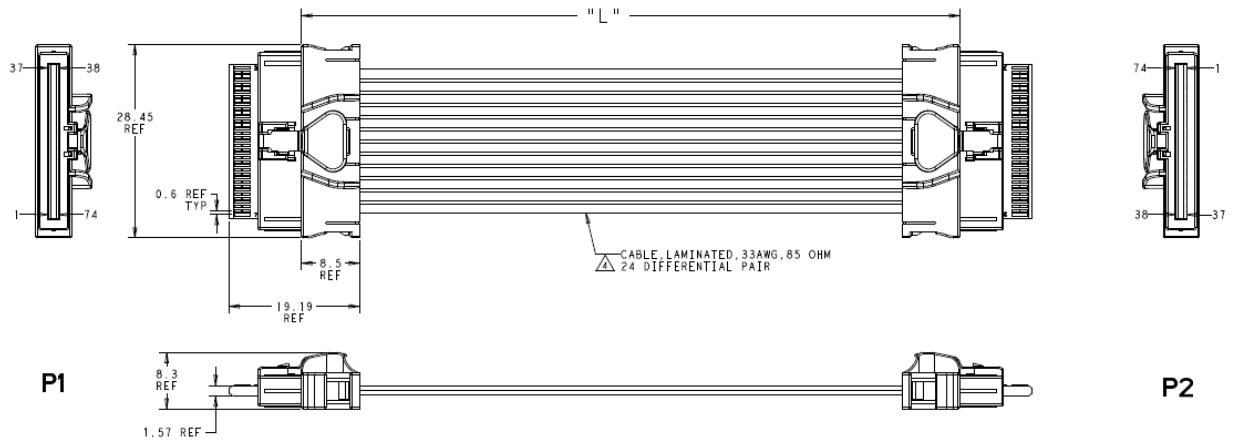

Sliver Cable Assemblies

Sliver 50 Position Right Angle Cable Assembly

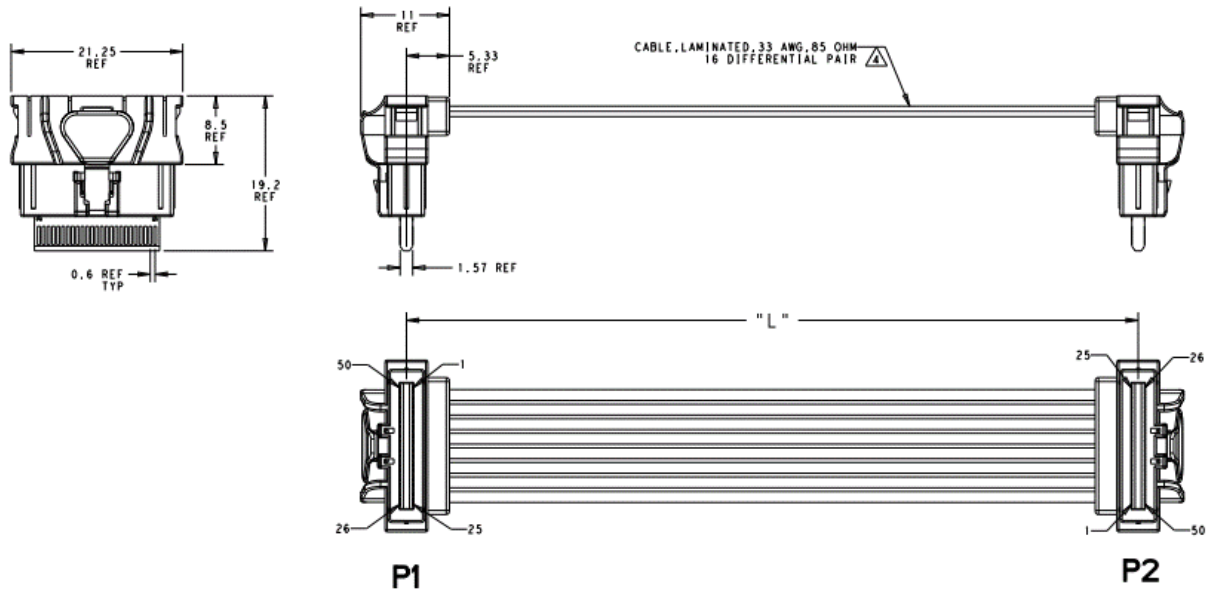

Sliver 74 Position Right Angle Cable Assembly

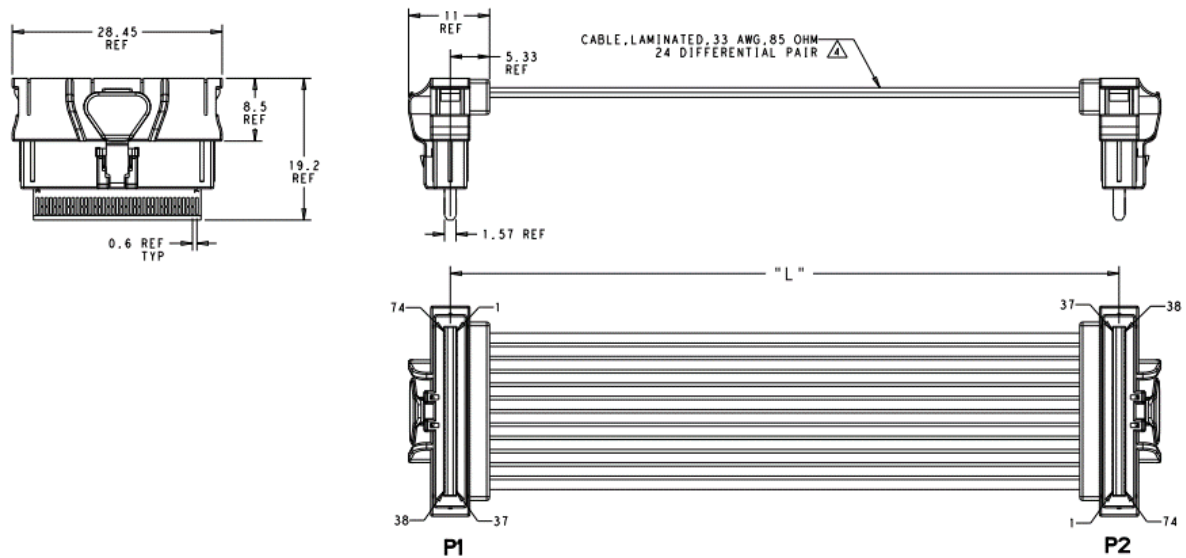

Sliver Cable Assemblies

SIGNAL INTEGRITY PERFORMANCE

Insertion Loss (SDD21) of 1m 33AWG 100 Ohm 25G Sliver

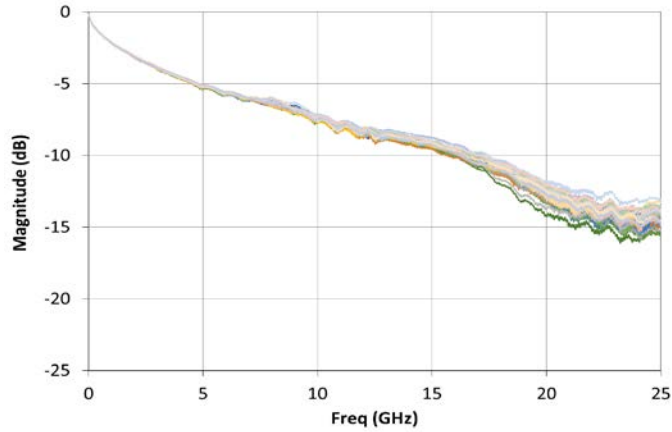

Mode Conversion (SCD21) of 1m 33AWG 100 Ohm 25G Sliver

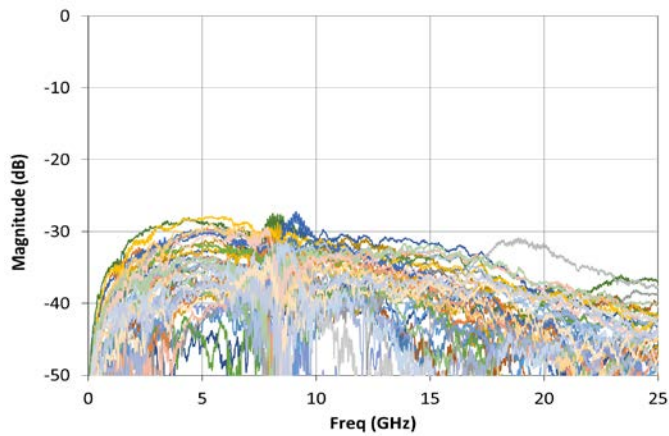

Return Loss (SDD11) of 1m 33AWG 100 Ohm 25G Sliver

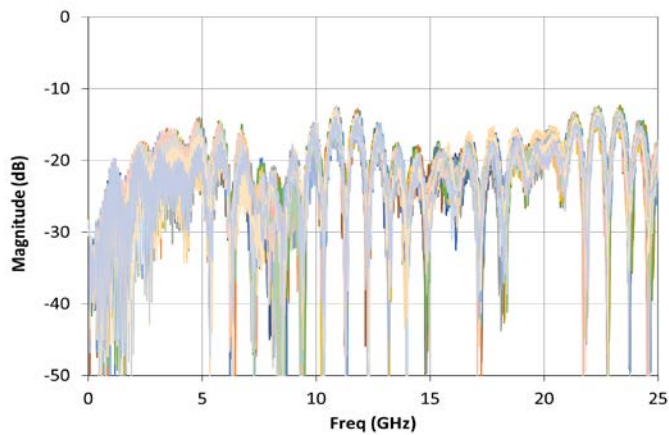

Sliver Cable Assemblies

Return Loss (SDD22) of 1m 33AWG 100 Ohm 25G Sliver

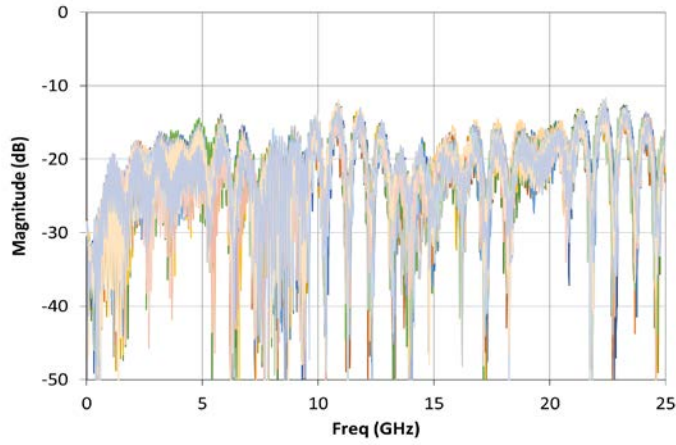

Insertion Loss (SDD21) of 1m 33AWG 85 Ohm 25G Sliver

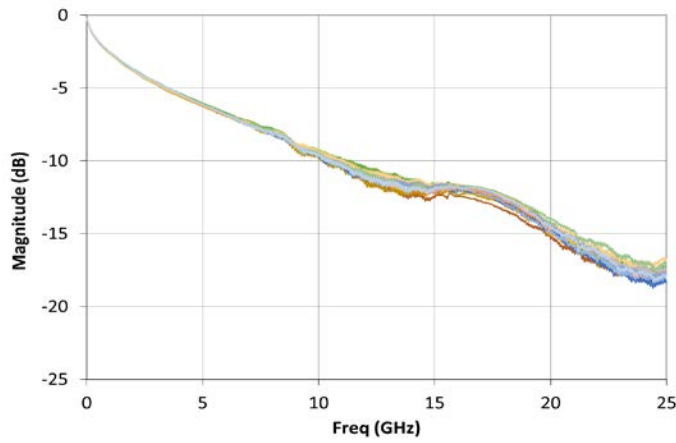

Mode Conversion (SCD21) of 1m 33AWG 85 Ohm 25G Sliver

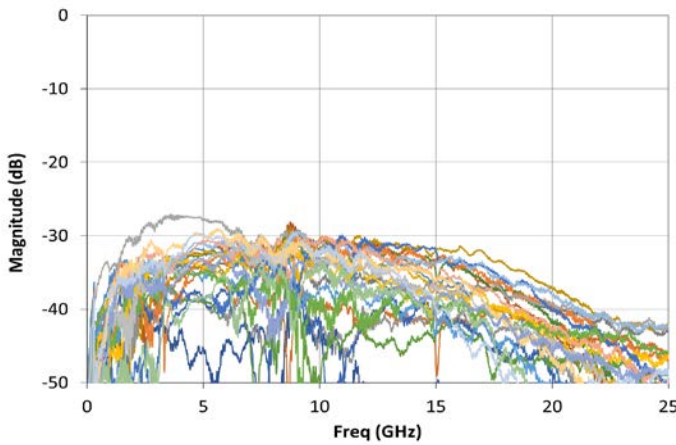

Sliver Cable Assemblies

Return Loss (SDD11) of 1m 33AWG 85 Ohm 25G Sliver

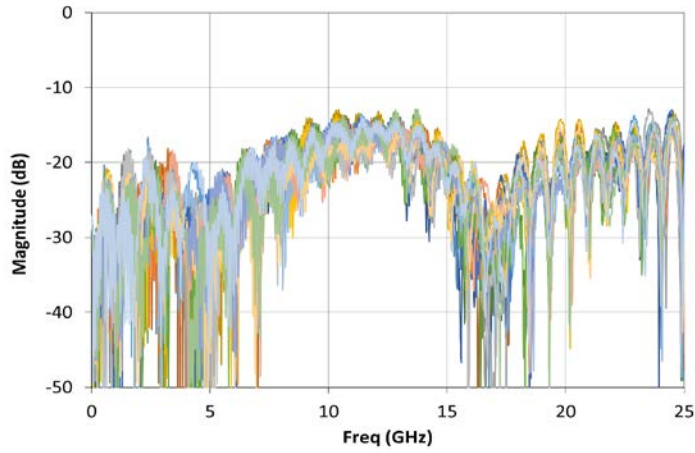

Return Loss (SDD22) of 1m 33AWG 85 Ohm 25G Sliver

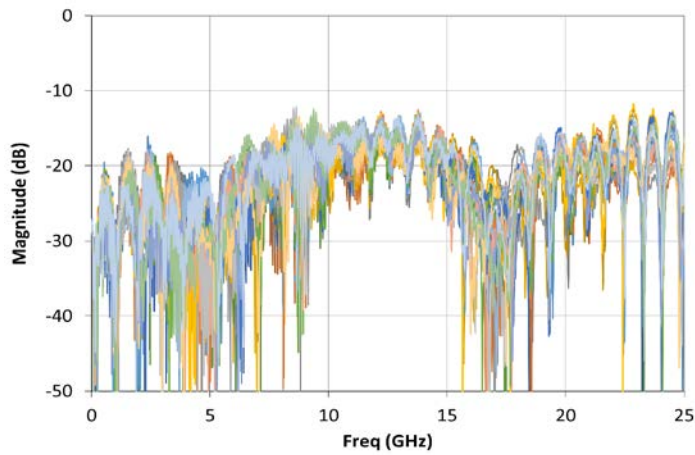

Insertion Loss (SDD21) of 1m 33AWG 100 Ohm 12G Sliver

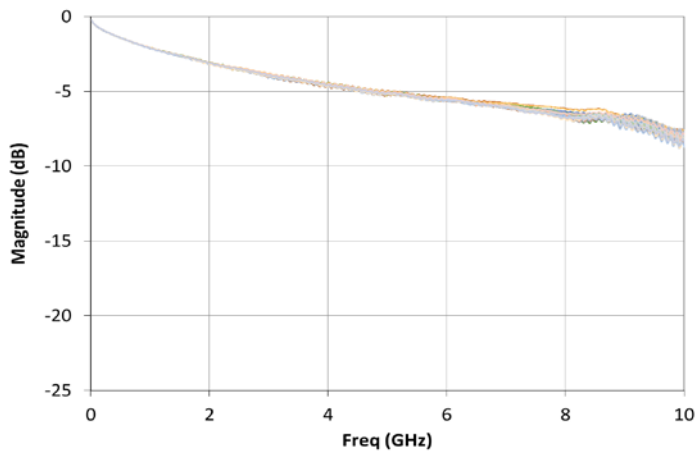

Sliver Cable Assemblies

Mode Conversion (SCD21) of 1m 33AWG 100 Ohm 12G Sliver

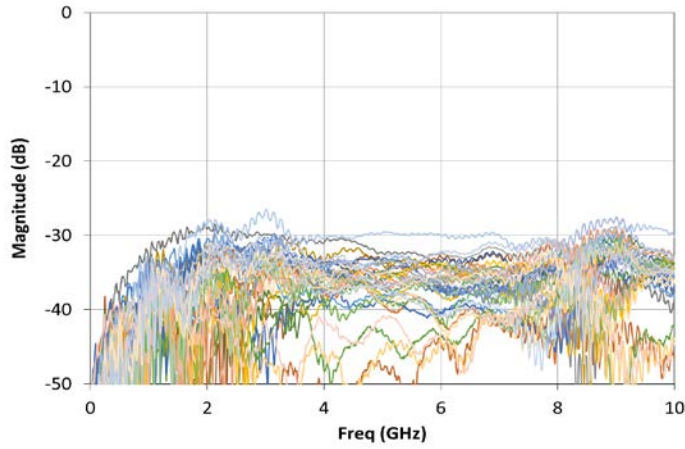

Return Loss (SDD11) of 1m 33AWG 100 Ohm 12G Sliver

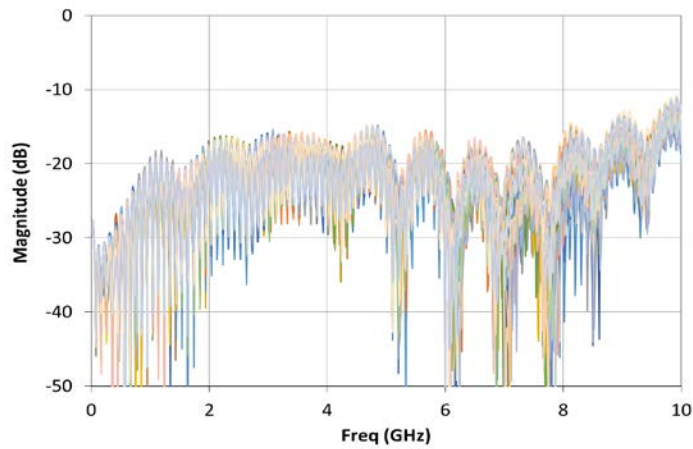

Return Loss (SDD22) of 1m 33AWG 100 Ohm 12G Sliver

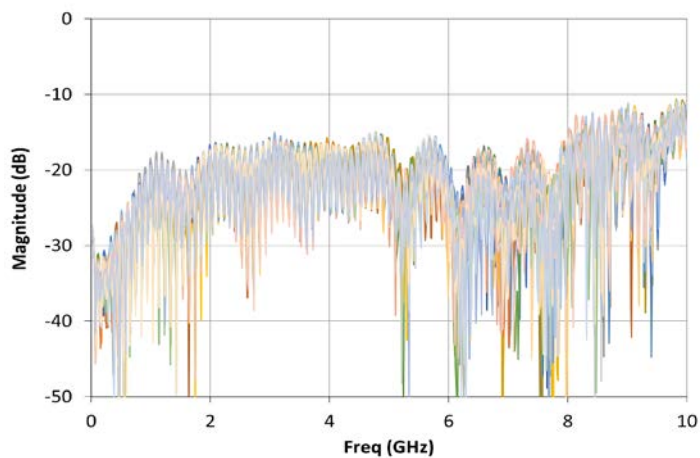

Sliver Cable Assemblies

Insertion Loss (SDD21) of 1m 33AWG 85 Ohm 12G Sliver

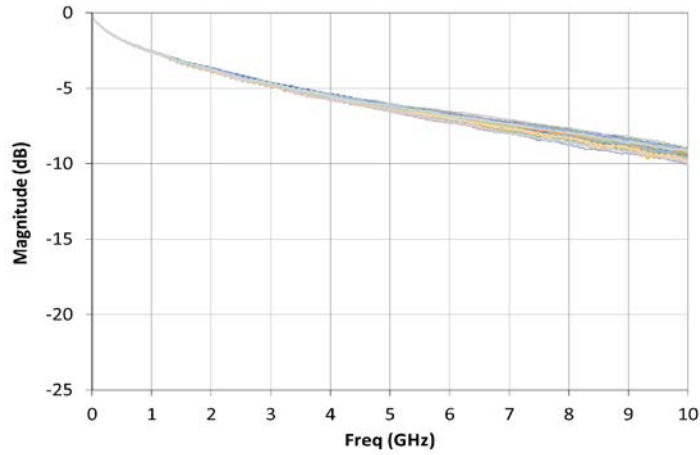

Mode Conversion (SCD21) of 1m 33AWG 85 Ohm 12G Sliver

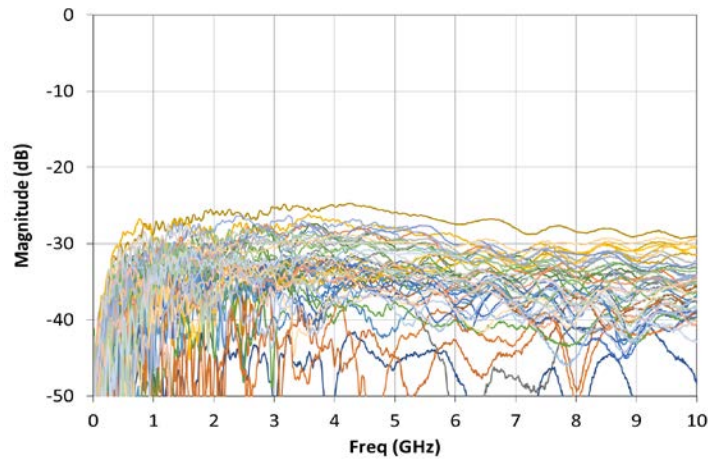

Return Loss (SDD11) of 1m 33AWG 85 Ohm 12G Sliver

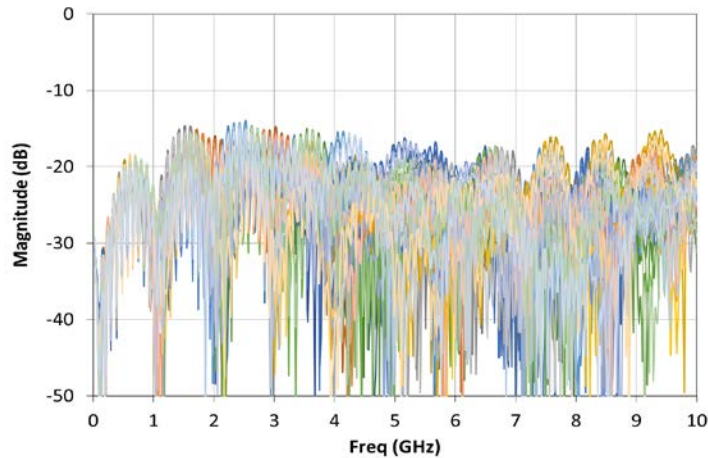

Sliver Cable Assemblies

Return Loss (SDD22) of 1m 33AWG 85 Ohm 12G Sliver

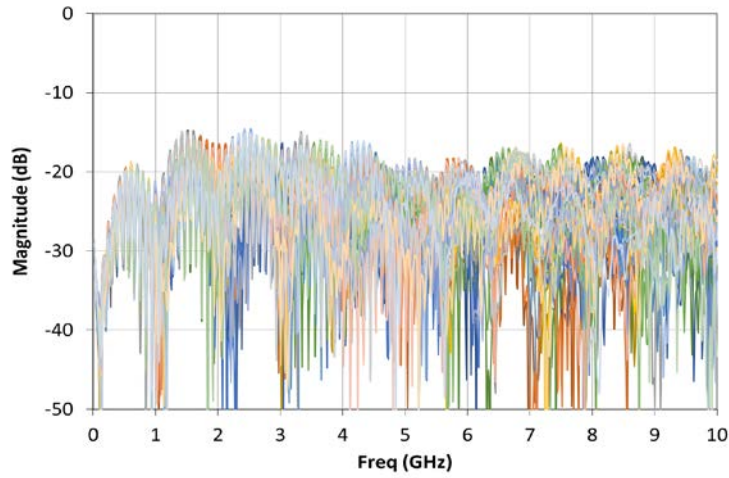

While TE has made every reasonable effort to ensure the accuracy of the information in this document, TE does not guarantee that it is error-free, nor does TE make any other representation, warranty or guarantee that the information is accurate, correct, reliable or current. TE reserves the right to make any adjustments to the information contained herein at any time without notice. TE EXPRESSLY DISCLAIMS ALL IMPLIED WARRANTIES REGARDING THE INFORMATION CONTAINED HEREIN, INCLUDING, BUT NOT LIMITED TO, ANY IMPLIED WARRANTIES OF MERCHANTABILITY OR FITNESS FOR A PARTICULAR PURPOSE. In no event will TE be liable for any direct, indirect, incidental, special or consequential damages arising from or related to recipient's use of the information. It is the sole responsibility of recipient of this information to verify the results of this information using their engineering and product environment. Recipient assumes any and all risks associated with the use of the information.