

# APPLICATION TOOLING

FOR MAGNET WIRE PROCESSING  
FROM TE Connectivity (TE)

# APPLICATION TOOLING

FOR MAGNET WIRE PROCESSING

**Inserters for MAG-MATE and SIAMEZE Terminals**

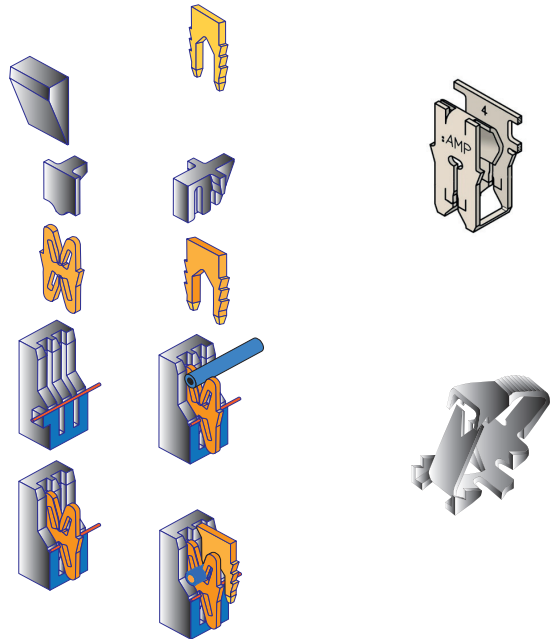

**AMPLIVAR Product Terminator (APT)**

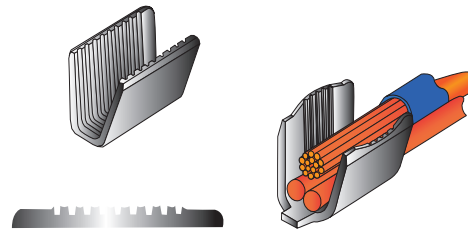

**AMP 5/K-40 Thru Splice Terminator**

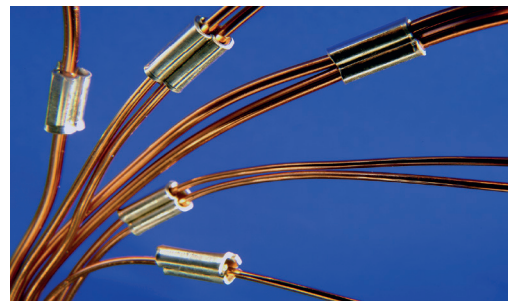

BY USE OF THESE TOOLS TE MAGNET WIRE TERMINALS ARE APPLIED, SEE THE FOLLOWING EXAMPLES:

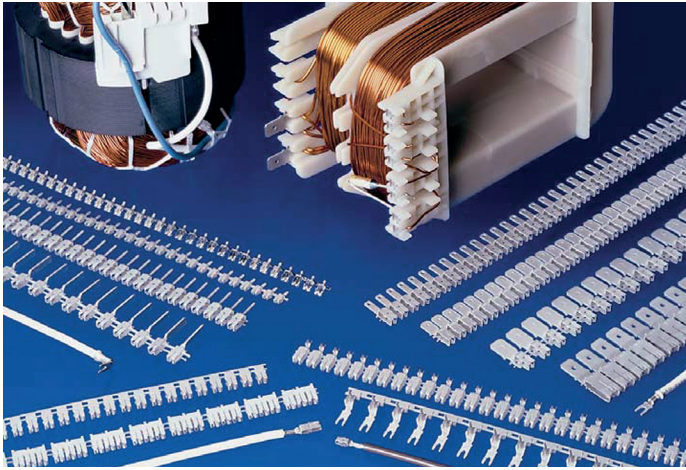

### **MAG-MATE Terminals**

**Standard .187 and .300 MAG-MATE Terminals**  
(Product Specification 108-2012)

**Standard .500 Box MAG-MATE Terminals**  
(Product Specification 108-2053)

**Slim Line MAG-MATE Terminals**  
(Product Specification 108-1484)

**Mini MAG-MATE Terminals**  
(Product Specification 108-2016)

See also Catalog 82221  
(Magnet Wire Terminals and Termination Systems)

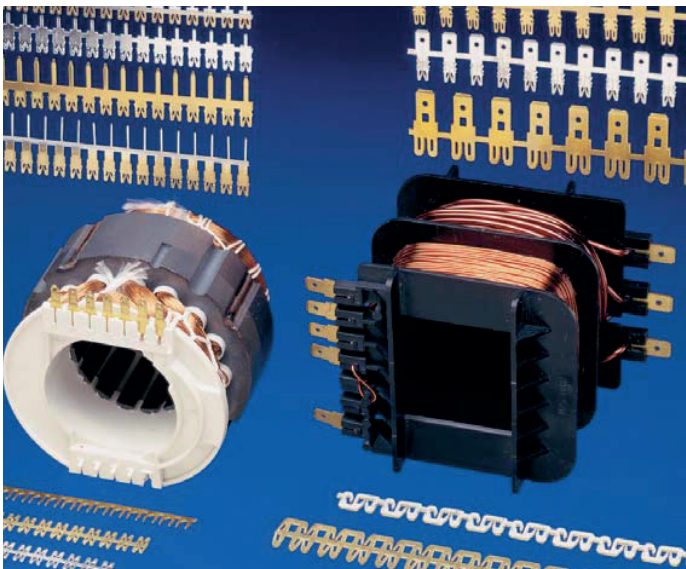

### **SIAMEZE Terminals**

**Standard Range SIAMEZE**  
(Product Specification 108-2085 )

**High Temperature Standard Range SIAMEZE**  
(Product Specification 108-2293 )

**Fine Range SIAMEZE**  
(Product Specification 108-2244 )

**Medium Range SIAMEZE**  
(Product Specification 108-2239)

**Heavy Range SIAMEZE**  
(Product Specification 108-2316 )

See also Catalog 82221

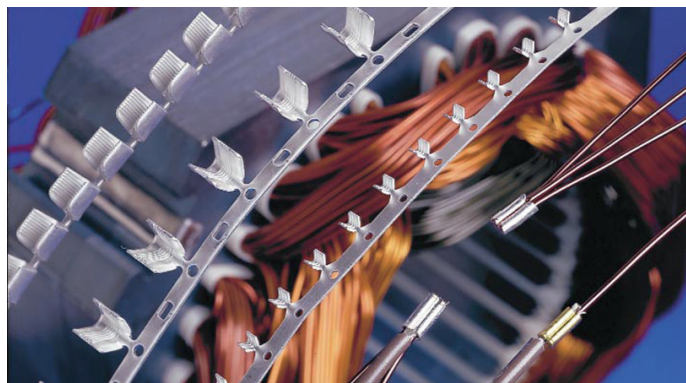

### **AMPLIVAR Splices**

**9 Serrations - Pigtail Type**

**7 Serrations - Pigtail Type**

**5 Serrations - Pigtail Type**

**5 Serrations - Pigtail Type**

**Miniature Splice - Pigtail Type**

See also Catalog 82221



# APPLICATION TOOLING

## FOR MAGNET WIRE PROCESSING

### MAG-MATE Insertion Equipment



### MAG-MATE Insertion Equipment

- Semi-automatic machine for integration into a manual workstation or production line
- The insertion machine can be installed horizontally or vertically according to the requirements
- Separate control cabinet
- Separate touch panel
- Pneumatically operated, compressed air 6 bars
- Insertion tools driven by compressed air cylinders

#### Technical Data:

- Weight: app. 17 kg
- Weight with Z axis movement: app. 22 kg
- Dimensions of inserter (D x W x H):  
600 mm x 220 mm x 165 mm  
(200 with Z axis movement)
- Diameter of contact reel: app. 630 mm
- Dimensions of control cabinet (D x W x H):  
210 mm x 380 mm x 480 mm (app)
- Power supply: 230 V, 50Hz, 6 A
- Sound level: < 70 db(A)
- Compressed air supply : 6 bars
- Compressed air connection: 1/8 “
- Air consumption (l/cycle): app. 2.8
- Contacting force: max 1000 N
- Cycle time: 0.9 - 1.3 sec (depending on operator)
- Temperature: 10°C - 45 °C
- Humidity: 30 % - 85 %, preferably 55 % (without condensation)
- Dusty environment to be avoided

#### Spare Parts

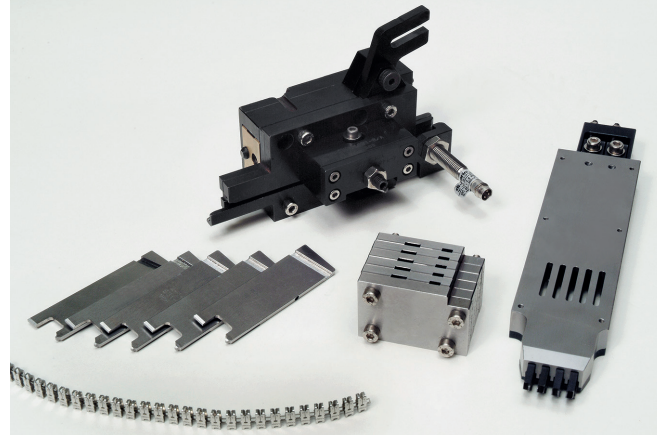

#### Calipper

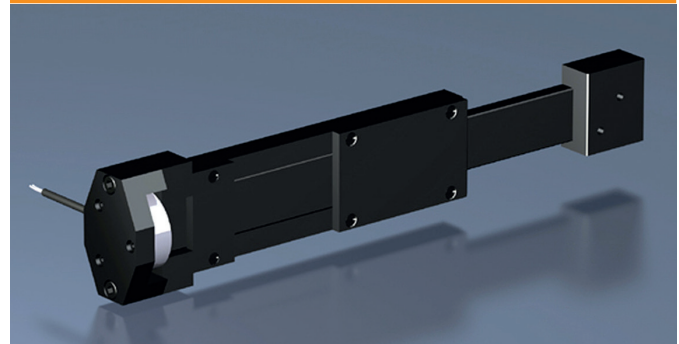

#### Options/Functions:

- Moving table
- Adapter plate
- Suction system for waste disposal
- Limitation of mechanical Insertion force
- Insertion force monitoring system
- Separate wire cutting function
- Bridge function for 2 / 3 / 4 contacts
- Touch screen
- Bridge function on/off
- Special function for Multispring contact application
- Fine-adjust of contact insertion depth
- Language module for user interface
- Electrical interface

**Overview on our full MAG-MATE modules portfolio, see Appendix A, page15.**

**Please contact our specialists for details.**



## MPT-5 Specifications (All Versions)

### Technical Data:

Air Requirements (Do NOT use lubricated air)

- Min Machine Working Pressure: 552 kPa [80 psi]
- Max (Preferred) Machine Working Pressure: 621 kPa [90 psi]
- Max Supply Line pressure: 1034 kPa [150 psi]

Electrical Requirements

- Voltage: 100-220 Vac
- Frequency: 50/60 Hz
- Circuit: Single Phase
- Current: 1.0 A
- Noise: 83dBA\_

With Scrap Vacuum Tube Located Away From Operator and in Scrap Container

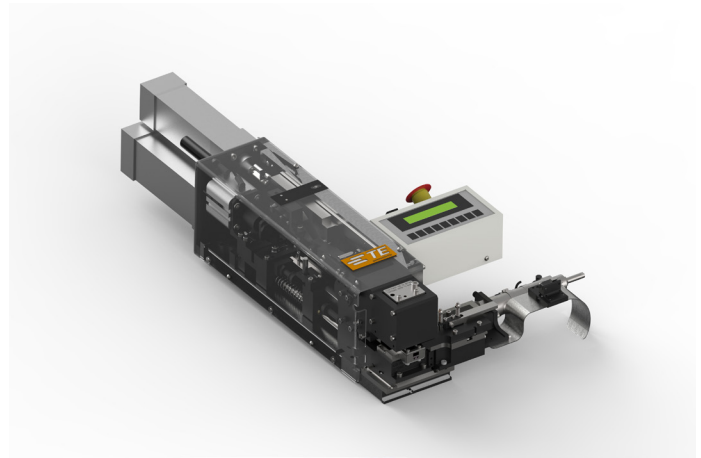
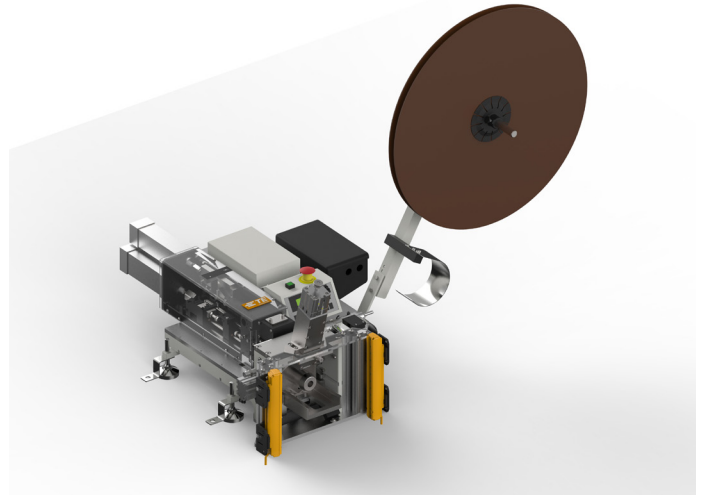

Note that the dimensions shown below are for the module only and do not include the electronic and pneumatic subassemblies, which must be mounted separately.

The MPT-5 product terminator machine **Horizontal Bench Machine** consists of a module, a horizontal adaptor kit, an electronic assembly and a pneumatic assembly.

The MPT-5 product terminator **Vertical Bench Machine** consists of a module, a "C" frame or "L" arm, an electronic assembly, and a pneumatic assembly.

### Options/Functions

- Moving Tube
- Customized fixtures
- Integrated scrap suction
- Independent wire cutting function
- Bridge function
- Right/Left feed capability (two different terminals)
- Selective bridge function (On-The-Fly Operations)
- Feed position fine adjust
- Depth position fine adjust

### DIMENSIONAL DATA\*

	Module Only	Horizontal Bench Machine	Vertical Bench Machine
Depth	711.2 mm [28 in.]	711.2 mm [28 in.]	737 mm [29 in.]
Height	304.8 mm [12 in.]	914.4 mm [36 in.]	1168 mm [46 in.]
Width	381 mm [15 in.]	812.8 mm [32 in.]	838 mm [33 in.]
Weight (Approx.)	22.7 kg [50 lbs]	43.1 kg [95 lbs]	113.4 kg [250 lbs]

\*Dimensions may vary depending on options and specific applications.

# APPLICATION TOOLING

## FOR MAGNET WIRE PROCESSING

### Insertion Process for MAG-MATE Terminals (Standard & Slim Line)

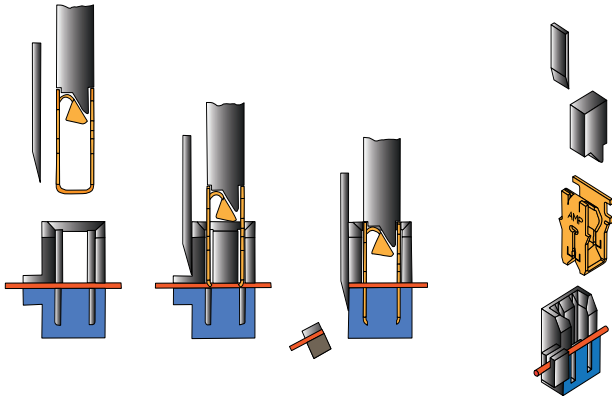

#### MAG-MATE:

Unstripped wire is inserted in the cavity through the slot, and makes contact with the bottom of the slot and top of the anvil.

The terminal is pushed through the inserter "tube" and positioned in the cavity by the insertion finger.

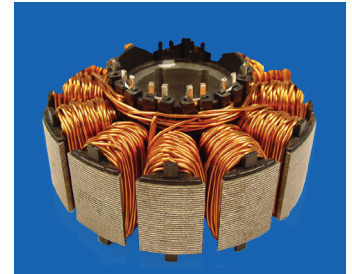
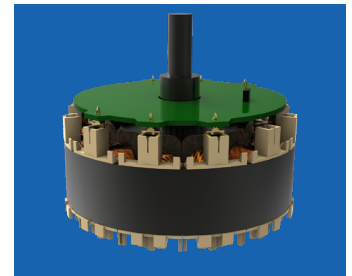
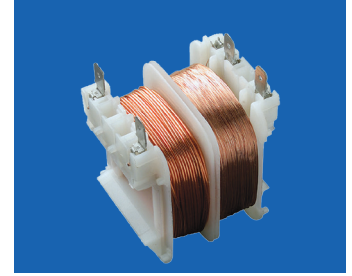

As the terminal is inserted into the cavity, the insulation film on the wire is stripped by the IDC slot and stripping shoulders, while the locking barbs on the terminal secure the terminal within the cavity. The post trim blade cuts the wire support block and scrap wire as the terminal is fully inserted into the cavity.

#### Terminal Examples

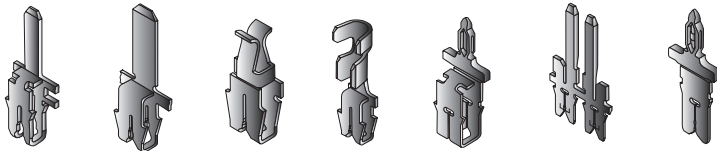

### Insertion Process for Mini MAG-MATE Terminals

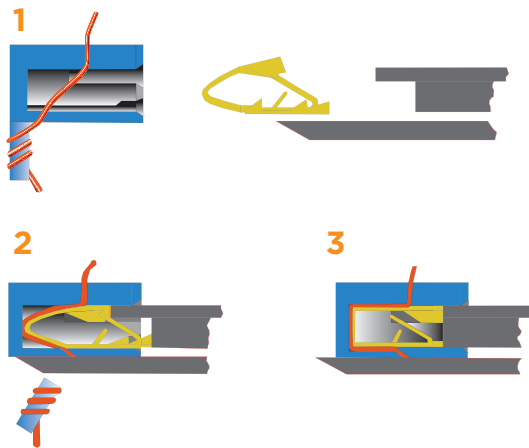

#### Mini MAG-MATE:

A smaller, Mini MAG-MATE Interconnection system is design for extremely small wire diameters. This terminal uses a unique cam action to provide the IDC contact without applying tension to the magnet wire.

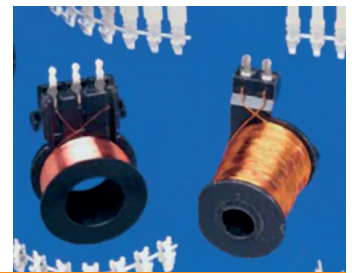
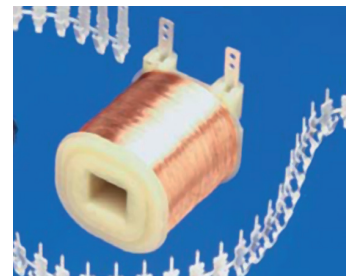

#### Terminal Examples

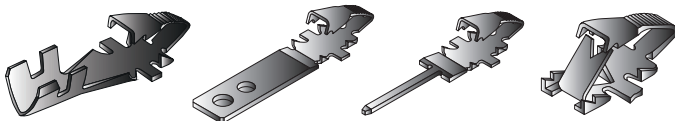

## Insertion Process for SIAMEZE Terminals

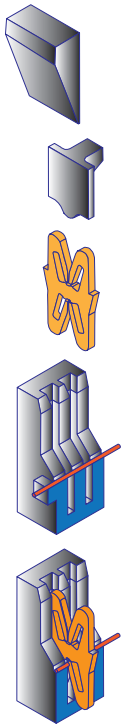

### Standard SIAMEZE:

For Siameze Terminals, the insertion process is quite similar to the MAG-MATE process, except with different specialized tooling. Please review the application specifications for Siameze insertion for the appropriate cavity geometry.

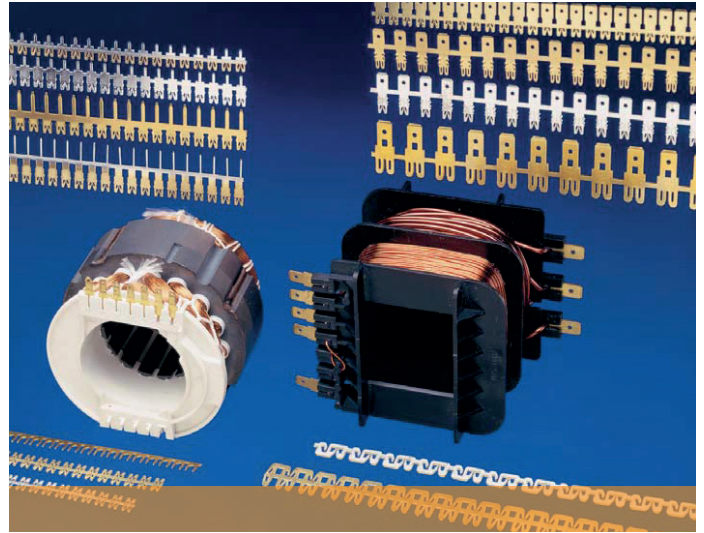

### Terminal Examples

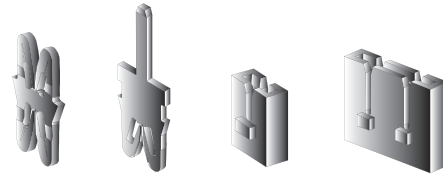

## Insertion Process for Leadlok/ SIAMEZE Terminals

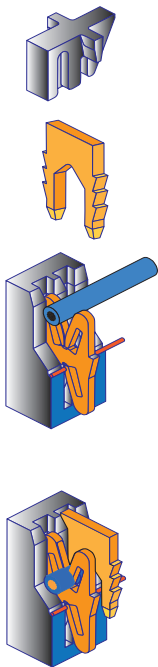

### SIAMEZE with Leadlok:

One of the advantages of the Siameze terminal is the ability to terminate both the magnet wire and lead wire in the same process. The Siameze terminal is inserted with the standard Siameze process, and a secondary insertion with the appropriate tooling applies the Leadlok terminal.

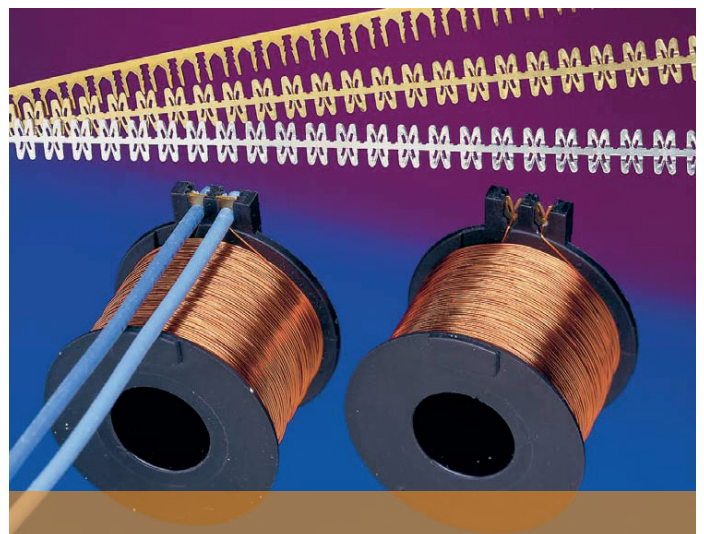



# APPLICATION TOOLING

## FOR MAGNET WIRE PROCESSING

### Combination with manually operated tools

#### MAG-MATE insertion combined with crimping

After MAG-MATE terminal insertion is done, the magnet wire coil has to be connected to the outside world: An example is the poke-in of a bare wire end or a crimped terminal into the MAG-MATE Terminal:

#### Poke-in of a stripped solid wire end

For these terminals you need a crimp tool, e.g. a CERTI-LOK hand tool or an SDE hand tool or a PRO-CRIMPER hand tool.

#### Poke-in of crimped terminal

For these terminals you need a crimp tool, e.g. a CERTI-LOK hand tool or an SDE hand tool or a PRO-CRIMPER hand tool.

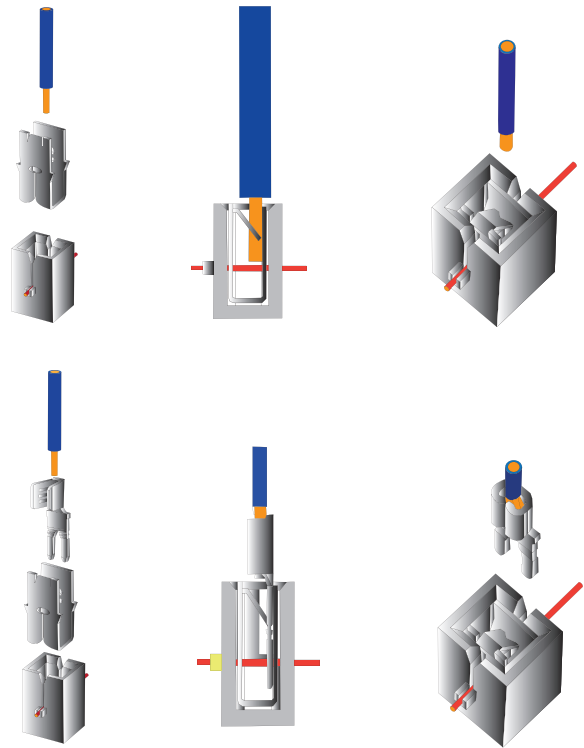

#### Crimp Terminal Examples

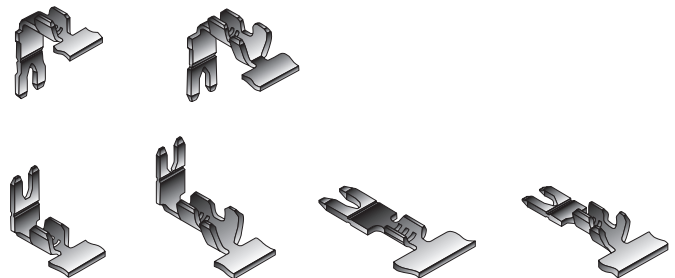

#### MAG-MATE terminal

##### Directly crimped

Inserted Terminals also can be crimped directly onto a stranded wire.

Example: Mini MAG-MATE terminal with crimp connection.



## Manually operated tools for repair and service

For repair & service , but also for prototyping it can be useful to work with manually operated tools. Here you find some examples. For further manually operated tools don't hesitate to contact our specialists.

### Manual MAG-MATE Terminal Application



## Manual SIAMEZE Leadlok Terminal Application

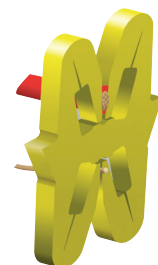
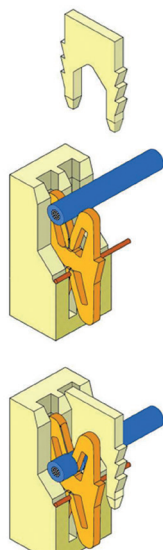
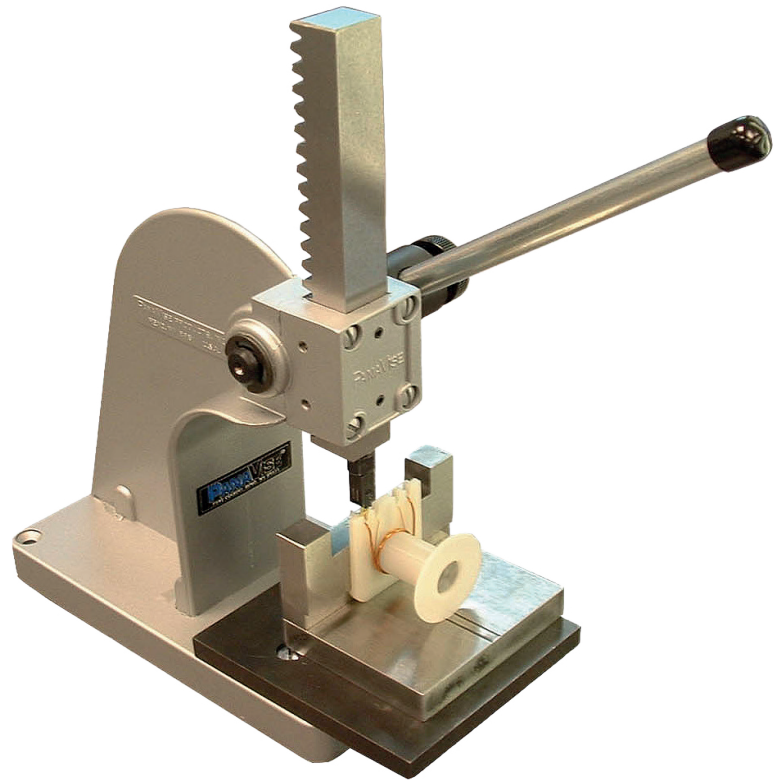

# APPLICATION TOOLING

## FOR MAGNET WIRE PROCESSING

### Work Center for semi automatic insertion of MAG-MATE or SIAMEZE terminals

We offer standardized or customized work centers, which are in line with the EU Machinery Directive 2006/42/EG. They are designed to automatically insert the terminals into the cavities of coil bodies. Correct positioning of the coil in front of the inserter is done either manually or automatically.

The work center consists of our inserter for MAGMATE and SIAMEZE contacts being integrated into a complete work environment.

After the coil is positioned, the terminals supplied on reels are cut off from the carrier strip and inserted into the contact chambers.

At this time the excess magnet wire is cut off and the other side terminated in the terminal cavity using insulation displacement technique.

Light grids assure protection of the worker during operation of the machine.

Easy operation of the work place is possible by a touch screen.

Insertion process is started by pedal switch.



Manual positioning of coil by use of a manually operated locator unit

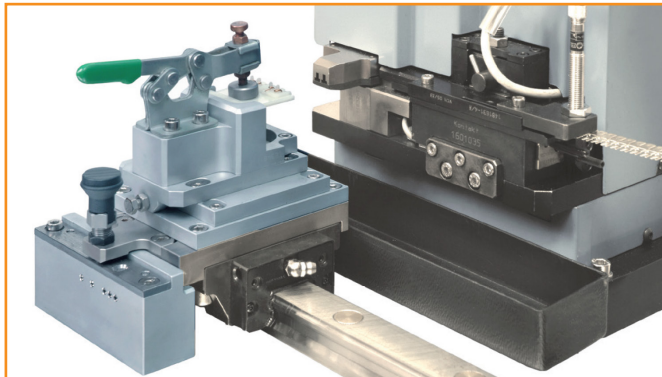

Locator for manual positioning

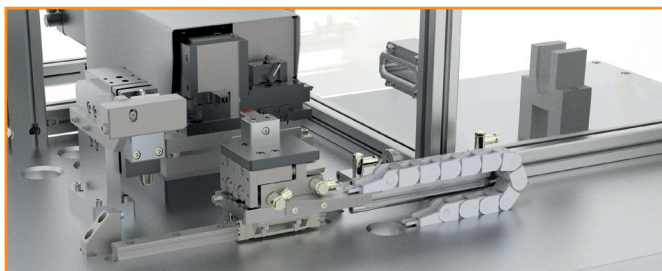

Locator for automatic positioning



Semi automatic positioning of coil by use of a motor-driven locator unit



## Workstation Application: MAG-MATE terminal with Multispring contact

### Case:

An electrical drive stator has to be combined with a PCB. The cavities of the stators are designed for MAG-MATE terminals. The thru holes of the PCB can be contacted by Multispring.

Needed: A combination of MAG-MATE IDC and press-fit contacting method.

### Solution:

MAG-MATE terminal with Multispring contact.  
After insertion of the terminals the PCB is pressed onto the housing by means of a connector seating device.

## Automatic Workstation

For rough work environment we also can offer robust designs for work places according to the specific needs of our customers.

Components and Controls (Examples)

- Inserter Machine
- Electrical Power Supply Unit
- Compressed Air Supply Unit
- Touch Screen
- Emergency Stop Button
- Light Grid
- Malfunction Light
- Safeguard
- On Button/Off Button

Please contact our specialists for full specification of the work center

## Bench-top Custom Solutions

Customized fixtures can be designed for specific applications. Processing two different terminals in the same machine provides our customers with the most economical solution, reducing processing and handling times.

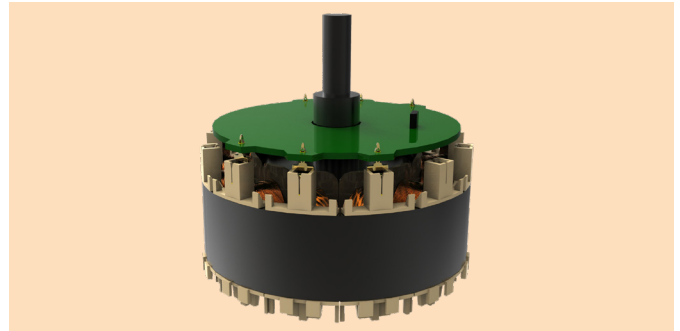
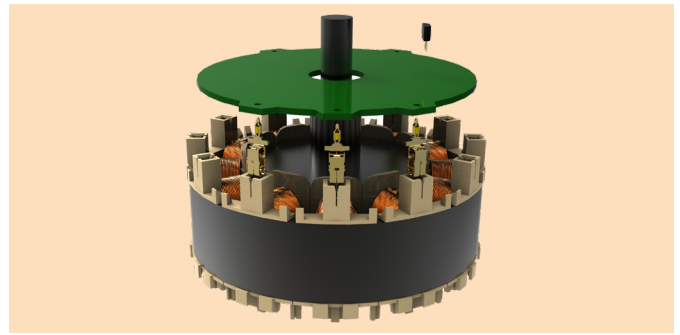

# APPLICATION TOOLING

## FOR MAGNET WIRE PROCESSING

### Splicing Equipment

**AMP 5/K-40 CE thru splice terminator stand-alone semiautomatic bench machine for end feed and for side feed AMPLIVAR terminals.**

#### Technical Data:

- Deflection: 0.13 mm [.0046 in.]  
Maximum per 4,448 Newtons [1,000 lb] Crimp Force
- Noise: Less than 82 dBa Typical at operator position with standard mechanical feed applicator
- Weight: 77.3 Kilograms [170.4 lb] – Height: 585 mm [23 in.] without reel supports
- Electrical: 100 - 240 Vac, 50/60 Hz, Single-Phase Current. Operating current is 3 amp
- Air: 620 - 760 kPa [90 - 100 psi], 2.83 liters/sec (6 scfm) When required for use with air feed applicators
- Physical Environment: Temperature: 4.45 - 40° C [40.5 - 104° F]
- Relative Humidity: Less than 95 % (non-condensing)



End-Feed and Side-Feed applicators used with AMP 5/K-40 CE through-splice terminators are two-piece applicators consisting of a tool holder and applicator base.

The tool holder is secured to the ram of the AMP 5/K-40 CE through-splice. All AMP 5/K-40 CE through-splice terminators are equipped with a “precision adjust” feature.

### Splicing Equipment

The wire ends being spliced together have to be inserted into a slot in the protection guard.

A sight window allows correct positioning of the wire ends over the open crimp terminal barrel.

The AMPLIVAR crimp terminals are either side feed or end feed terminals. Accordingly a side feed or end feed applicator has to be installed into the thru splice terminator.



**AMPLIVAR  
Side feed  
terminal**

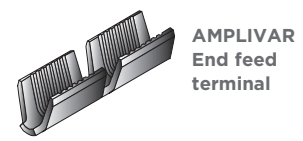

**AMPLIVAR  
End feed  
terminal**

**Side feed applicator with  
protection guard**

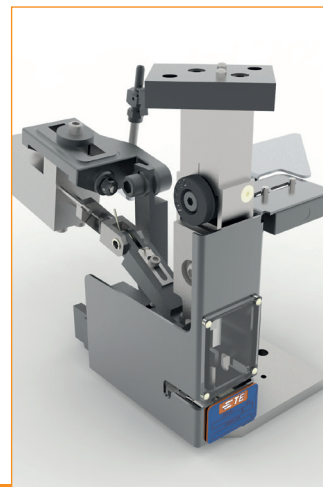

**End feed applicator with  
protection guard**

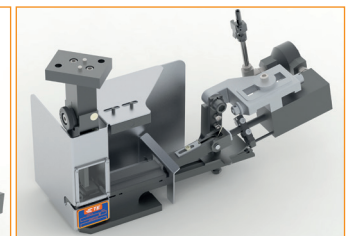

**Additional hand protection guard**



## Splicing Equipment Pigtail Splices

AMPLIVAR product terminator (APT)  
For pigtail-type splices (up to 3 wires in 1 splice) and  
direct connect contacts

### Technical Data:

- Weight: approx. 68 kg with CQM
- Width: 965 mm with CQM and
- Product Reel
- Depth: 890 mm
- Height: 356 mm
- Electrical: 240 VAC, 50 Hz, .5 A, 1 f
- Air: 5,5-7,5 bar
- Crimp Height Adjust in .0005 “ [0.013 mm] increments over .064” range



For operations with multiple wire sizes, the APT 5A provides programmable sequencing of different crimp-height settings, and it can store up to 2,000 different programs of 7 different settings each. The maximum time to auto-adjust between programmed crimp heights is 2 seconds.

## Splicing Equipment Pigtail Splices

### Termination process:

- Magnet wire and lead wire are placed in the terminal barrel being in the crimping position
- Operator depresses the foot switch
- Terminator automatically
  - shears terminal from its strip
  - crimps the terminal onto the wire
  - shears off the excess wire
  - advances the next terminal into the crimping position

### Remarks:

- Two or three wires may be joined in one splices
- Terminator designed for combinations of magnet wire and lead wire (stranded, solid or fused stranded)
- Large number of wire combinations requires some tooling changes
- For the correct tooling selection, please contact our specialists



- If customer CMA is less than the minimum published CMA for the AMPLIVAR product, we offer our wire stuffer assembly 2161635-1 as an option. This option provides additional magnet wire CMA to the terminated CMA to meet the specified CMA range for a given AMPLIVAR product.

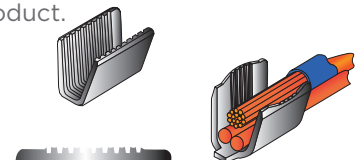



# TE CONNECTIVITY APPLICATION TOOLING: IDC MACHINE QUOTATION QUESTIONNAIRE

Please provide the following information so we can create an accurate quote for your production needs.

## Contact Information:

Company Name: \_\_\_\_\_  
Contact Name: \_\_\_\_\_

Company Address: \_\_\_\_\_

Contact Email: \_\_\_\_\_

Contact Phone: \_\_\_\_\_

## Product Information:

Has your application been reviewed by a TE Connectivity Terminal Application Specialist?  Yes  No  
If so, who did you work with? \_\_\_\_\_

Please list all terminals to be inserted in this application: \_\_\_\_\_

What products are you interested in?  Complete bench machine and fixture  Module only

If a fixture is requested, what level of automation is needed?  Manual  Semi-Automatic  
 Automated Line Integration

If the machine is integrated into a line, is host control required?  Yes  No

Will the machine be robotically loaded?  
 Yes  No

What is your expected yearly terminal usage?  
\_\_\_\_\_

Will the machine be replacing an existing AMP or TE Connectivity machine?  Yes  No

What timeframe do you expect for the start of production? \_\_\_\_\_

If you are replacing an existing machine, what is the machine part number? \_\_\_\_\_

### Please submit this form to:

magnetwireus@te.com  
Mailstop 140-50 P.O. Box 3608  
Harrisburg, PA 17105-3608, USA

## Specifications and Testing:

Do you have any machine specifications or requirements?  Yes  No

For best results, please review "Best Practices for IDC Magnet Wire Termination," which can be found with other useful information at [tooling.te.com](http://tooling.te.com)

Do you have any testing/acceptance requirements?  
 Yes  No

\*Are you able to provide 5-10 samples of product for initial review?  Yes  No

\*\*Do you require a run off of the machine?  
 Yes  No

If you answered "Yes" to any of the questions regarding specifications and testing, please attach all appropriate documentation.

## Attachments:

In order to produce a complete quote, all of the following items must be attached. If not all documentation is currently available, a budgetary quote can be provided.

- Detailed, fully dimensioned and toleranced drawings of bare bobbin/stator including material (e.g. 15% GF nylon)
- Drawings of Completed Assembly [Including: TE terminal(s) part number(s), terminal orientation in cavity, magnet wire type (e.g. AL, CU), magnet wire gage, wrap-off trim (required or not required)]
- 3D Models of the bobbin/stator assembly (CREO or .STP format) if available
- All information on the wire that will be used for this application including, but not limited to: gage, number of strands, material, insulation type.

Please Note: \*Customers are required to provide terminals and bobbins/stators for all machine conditioning and qualification. \*\*Additional charges may apply.

## APPENDIX A: Overview on our full MAG-MATE MODULE portfolio

No	Options	MAG-MATE pneumatic	MPT-5	MAG-MATE MK I	MAG-MATE MK II
1	Moving Table	X		X	X
2	Moving Tube		X		
3	Adapter Plate	X		X	X
4	Suction system for waste disposal	X	X	X	X
5	Insertion force limitation, mechanical			X	X
6	Insertion force monitoring				X
7	Separate wire cutting unit		X		X
8	Bridge function, 2 contacts	X	X	X	X
9	Bridge function, 3 contacts		X	X	X
10	Bridge function, 4 contacts			X	X
11	Touch screen			X	X
12	Bridge On/Off function		X	X	X
13	Processing function for Multispring		X		X
14	Fine adjust insertion depth		X		X
15	Language module for user interface			X	X
16	Electrical interface for base machine		X	X	X



## Let's Connect

To learn more about the right TE tooling for your needs, call us at 717-810-2082 or email [ToolingSales@te.com](mailto:ToolingSales@te.com)



## TE Technical Support Center

USA:	1.800.522.6752	UK:	+44.0800.267666
Canada:	1.800.522.6752	France:	+33.1.34.20.8686
Mexico:	+52.55.11.06.0800	Netherlands:	+31.73.624.6999
Latin/S. America	+54.11.4733.2200	China:	+86.400.820.6015
Germany:	+49.6151.607.1999		

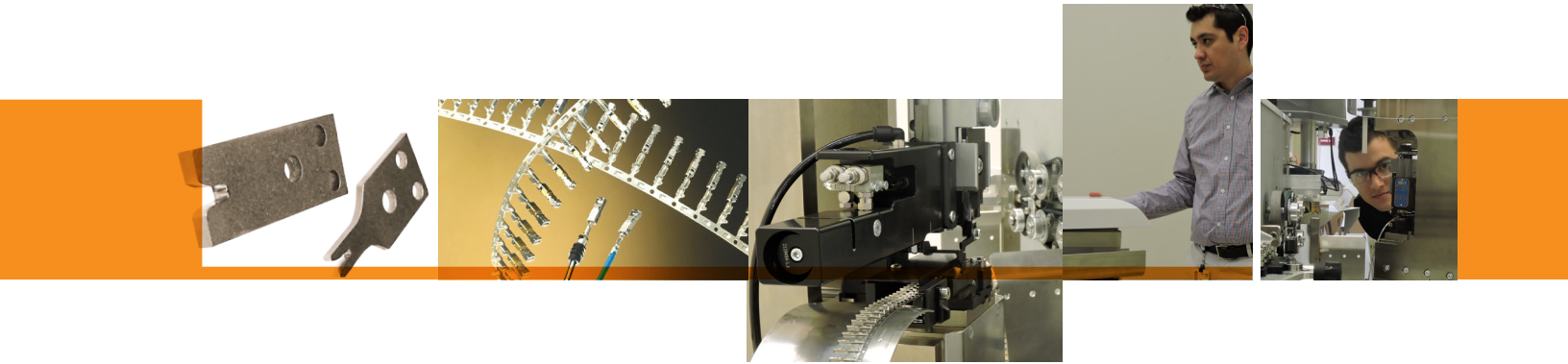

### Time is Money.

In manufacturing downtime can be expensive. That's why TE is constantly working to improve product availability and delivery

rates. With a strong global footprint, short lead times and a strong distribution channel, TE has the equipment and the accessories to keep production online.

To check distributor stock and availability for your tooling needs go to: [www.te.com/commerce/sck/cdi.do](http://www.te.com/commerce/sck/cdi.do)



### Waste Not. Want Not.

Whether its time or scrap, in manufacturing everyone knows that waste costs money. With our on-site certification and consultation services, we can help you:

- Reduce downtime
- Reduce scrap
- Maintain crimp quality
- Improve manufacturing efficiency

Connect with us today to learn more.

- E-mail: [fieldservicesnorthamerica@te.com](mailto:fieldservicesnorthamerica@te.com)
- Phone: **800-722-1111 or 717-986-3434**
- For additional information download catalog **#1-1307619-0** from [tooling.te.com](http://tooling.te.com).

Catalog 1-1773899-1/ 11-18 / Application Tooling

TE connectivity (logo) and TE Connectivity are trademarks.