

P	LTR	DESCRIPTION	DATE	DWN	APVD
	A	NEW DRAWING	24SEP2020	GK	DB

LABEL AND LINER DESIGN

PRESENTATION

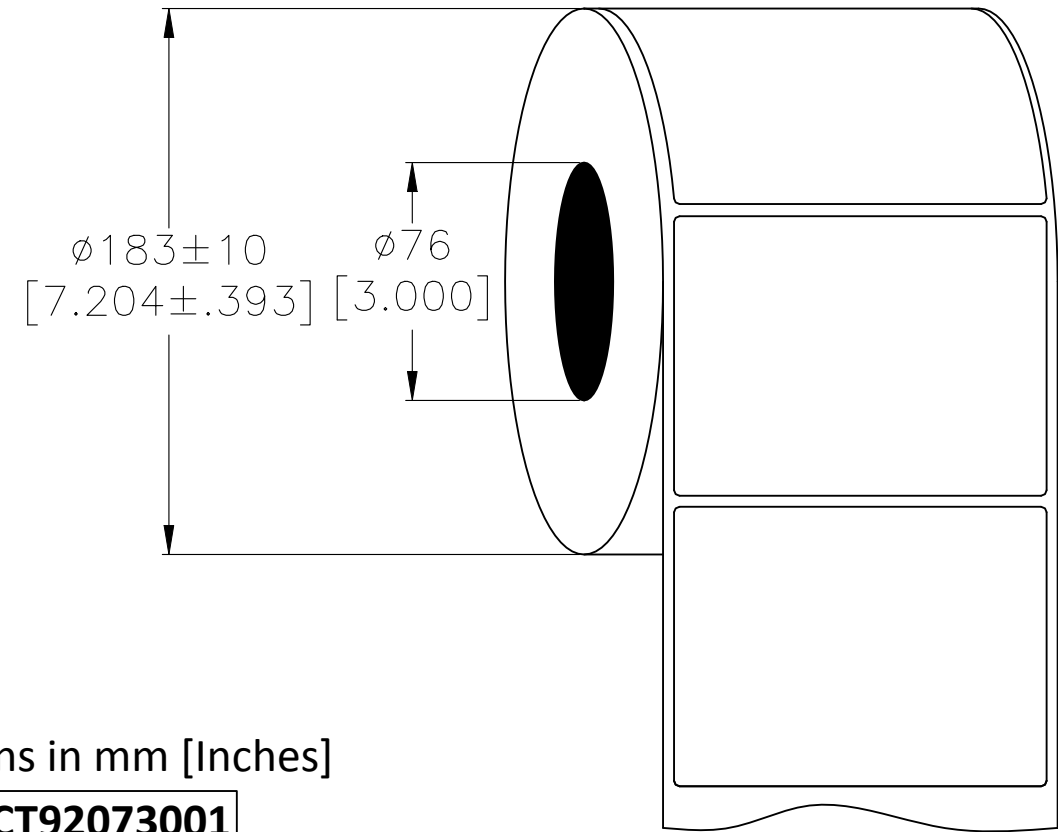
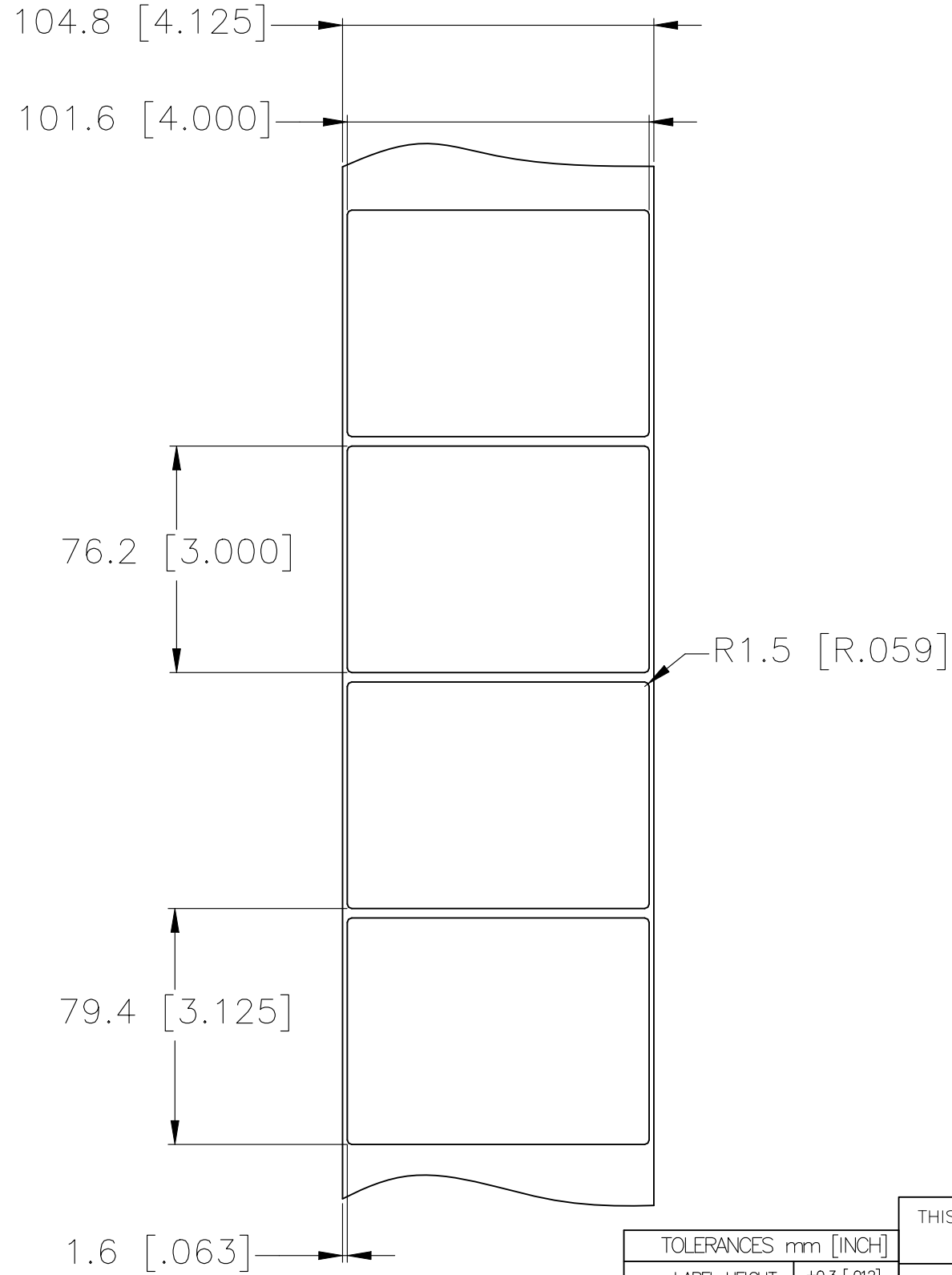

All dimensions in mm [Inches]

TE PN: CT92073001

**OUTSIDE WOUND
 LABEL ACROSS: 1
 PER ROLL QTY: 1800**

MATERIAL	WHITE POLYESTER
ADHESIVE TYPE	ACRYLIC PERMANENT
LINER	WHITE GLASSINE

TOLERANCES mm [INCH]	
LABEL HEIGHT:	±0.3 [.012]
LABEL WIDTH:	±0.3 [.012]
WEB WIDTH:	±2.0 [.079]
VERTICAL REPEAT:	±0.8 [.031]*
HORIZONTAL REPEAT:	±0.8 [.031]*
PRINT POSITIONING:	±0.8 [.031]*
LEFT MARGIN:	±0.7 [.027]
QUANTITY:	-0 % +2 %
*NON ACCUMULATING	

THIS DRAWING IS A CONTROLLED DOCUMENT.	
DIMENSIONS: mm [INCHES]	TOLERANCES UNLESS OTHERWISE SPECIFIED:
	0 PLC ± -
	1 PLC ± -
	2 PLC ± -
	3 PLC ± -
	4 PLC ± -
ANGLES ± -	± -
MATERIAL SEE TABLE	FINISH -

DWN	24SEP2020
GOPALAKRISHNA HV	
CHK	24SEP2020
D. BURGAT	
APVD	24SEP2020
D. BURGAT	
PRODUCT SPEC	
TTDS-301	
APPLICATION SPEC	
WEIGHT	0.945g

TE Connectivity		NAME	
		White Polyester Chemical Resistant - 101.6 x 76.2mm [4.0 x 3.0inch]	
SIZE	CAGE CODE	DRAWING NO	RESTRICTED TO
A3	FB1U7	C=WPCR-101762-1.8-9	-
CUSTOMER DRAWING		SCALE	SHEET
		NTS	1 OF 1
		REV	A