

WITH ATTACHMENT

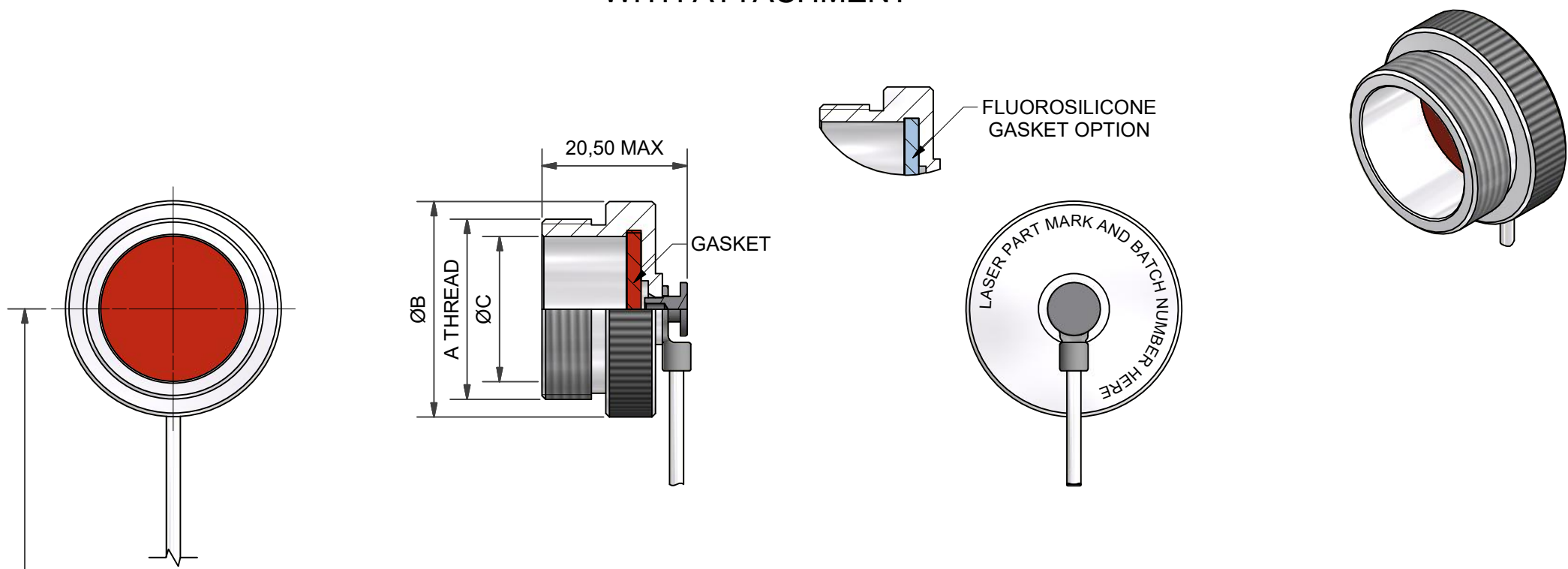

ATTACHMENT OPTIONS:

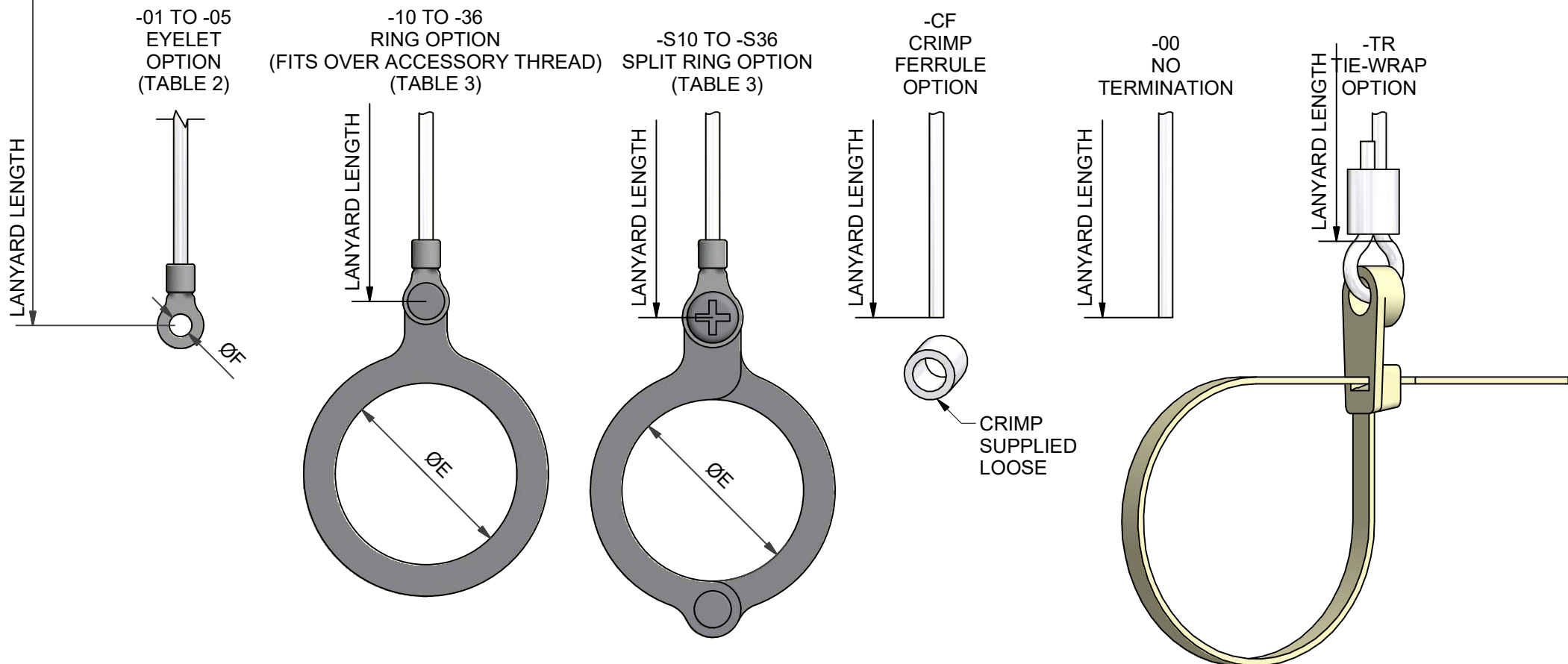

OMIT FOR NO ATTACHMENT  
(SEE SHEET 2)

100P1167-16-1-C-WR4-16

SERIES  
 INSERT 'F' FOR FLUOROSILICONE GASKET  
 OMIT FOR STANDARD SILICONE GASKET  
 SHELL SIZE (TABLE 1)  
 MATERIAL (TABLE 5)  
 FINISH (TABLE 6)  
 LANYARD TYPE (TABLE 4)  
 LANYARD LENGTH (IN INCHES)  
 +1,0"/-0" TOLERANCE  
 ATTACHMENT (SEE ABOVE)

<table border="1"> <tr> <td>DRAWN</td> <td>J.CLARK</td> <td>DATE</td> <td>14/10/2019</td> </tr> <tr> <td>SALES APPR</td> <td></td> <td>DATE</td> <td>14/10/2019</td> </tr> <tr> <td>DESIGN APPR</td> <td></td> <td></td> <td></td> </tr> <tr> <td>PROD APPR</td> <td></td> <td></td> <td></td> </tr> <tr> <td>QUAL APPR</td> <td></td> <td></td> <td></td> </tr> <tr> <td>ISSUE</td> <td>REV.</td> <td>DCR</td> <td></td> </tr> <tr> <td>AA</td> <td></td> <td>7332</td> <td></td> </tr> </table>	DRAWN	J.CLARK	DATE	14/10/2019	SALES APPR		DATE	14/10/2019	DESIGN APPR				PROD APPR				QUAL APPR				ISSUE	REV.	DCR		AA		7332		<p>3RD ANGLE PROJECTION NOT TO SCALE</p>	<p>PART NUMBER:</p> <p><b>100P1167 SERIES</b></p> <p>TITLE:</p> <p><b>PLUG PROTECTION COVER</b></p> <p>ASSY USED ON: MIL-DTL-5015</p>	<p>Polamco</p> <p>TE connectivity</p>
DRAWN	J.CLARK	DATE	14/10/2019																												
SALES APPR		DATE	14/10/2019																												
DESIGN APPR																															
PROD APPR																															
QUAL APPR																															
ISSUE	REV.	DCR																													
AA		7332																													
<p>UNLESS OTHERWISE SPECIFIED ALL DIMENSIONS IN MILLIMETRES</p> <p>GENERAL TOL                  LINEAR +/-0,25MM                  ANGULAR +/- 1°</p> <p><b>MATERIAL</b>                  SEE PART NUMBER BREAKDOWN</p> <p><b>FINISH</b>                  SEE PART NUMBER BREAKDOWN</p>	<p>THIS DRAWING IS COPYRIGHT AND THE PROPERTY OF POLAMCO LTD IT MUST NOT BE COPIED, USED FOR MANUFACTURE OR OTHERWISE DISCLOSED WITHOUT PRIOR WRITTEN CONSENT OF THE COMPANY.</p>	<p>POLAMCO LTD, WESTON LOCK, LOWER BRISTOL ROAD BATH BA2 1EP</p>	<p>SHT 1</p> <p>DRAWING NO: P12066</p>																												
<p>NCAGE CODE U5792</p> <p>WEIGHT</p>																															

TABLE 1

SHELL SIZE	A THREAD	ØB MAX	ØC MIN
10SL	5/8-24 UNEF	24,2	11,50
12S	3/4-20 UNEF	24,2	14,77
14S	7/8-20 UNEF	26,6	17,50
16S	1-20 UNEF	30,4	20,50
16	1-20 UNEF	30,4	20,50
18	1 1/8-18 UNEF	32,5	24,00
20	1 1/4-18 UNEF	35,7	27,50
22	1 3/8-18 UNEF	38,9	30,00
24	1 1/2-18 UNEF	42,1	33,10
28	1 3/4-18 UNS	48,5	39,10
32	2-18 UNS	54,8	46,50
36	2 1/4-16UN	60,2	52,90

TABLE 2

EYELET REF.	ØF
01	3,2
02	3,7
03	4,3
04	5,3
05	6,4

TABLE 3

RING REF.	ØE
10	16,1
12	19,4
14	22,6
16	25,8
18	27,8
20	30,6
22	34,1
24	36,9
28	44,6
32	51,2
36	57,5

TABLE 4

CODE	LANYARD TYPE
WR	NYLON COVERED (CLEAR) STAINLESS STEEL WIRE ROPE
TC	TEFLON COVERED (CLEAR) STAINLESS STEEL WIRE ROPE
WG	TEFLON COVERED (OLIVE DRAB) STAINLESS STEEL WIRE ROPE
WB	TEFLON COVERED (BLACK) STAINLESS STEEL WIRE ROPE
WRB	PVC COVERED (BLACK) STAINLESS STEEL WIRE ROPE
LC	LINK CHAIN
BK	BLACK CORD
VGB	1,5mm BLACK POLYESTER CORD EQV. TO DIN83330-E1,5
R	OLIVE DRAB POLYESTER CORD
NB	OLIVE DRAB NYLON CORD
NK	BLACK NYLON CORD

TABLE 5

CODE	MATERIAL
1	ALUMINIUM
2	NICKEL ALUMINIUM BRONZE
4	STAINLESS STEEL
7	BLACK ACETAL
74	COMPOSITE

LIST NOT EXHAUSTIVE, SEE MATERIAL TABLE FOR OTHER OPTIONS

TABLE 6

CODE	DESCRIPTION
B	CADMIUM, OLIVE DRAB OVER ELECTROLESS NICKEL
C	ELECTROLESS NICKEL
G	BLACK ANODISE, SULPHURIC
J	PASSIVATE
U	UNPLATED CLEAN FINISH NOT SHOT BLASTED
Z	SHOT BLAST FOR NON-REFLECTIVE FINISH
ZB	ZINC COBALT OLIVE DRAB OVER ELECTROLESS NICKEL
ZN	ZINC NICKEL BLACK PASSIVATE OVER ELECTROLESS NICKEL

LIST NOT EXHAUSTIVE, SEE PLATING TABLE FOR OTHER OPTIONS

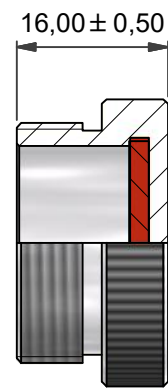

### WITHOUT ATTACHMENT

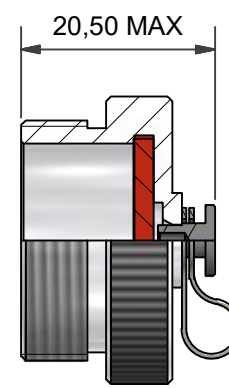

100P1167-16-1-C  
NO ATTACHMENT VERSION

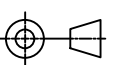

100P1167-16-1-C-EO  
EYELET ONLY VERSION  
(NO LANYARD)

DRAWN	J.CLARK	DATE	14/10/2019	 3RD ANGLE PROJECTION NOT TO SCALE	PART NUMBER:	100P1167 SERIES			 Polamco			
SALES APPR		DATE	14/10/2019		TITLE:	PLUG PROTECTION COVER						
DESIGN APPR		UNLESS OTHERWISE SPECIFIED ALL DIMENSIONS IN MILLIMETRES		<b>MATERIAL</b> SEE PART NUMBER BREAKDOWN  <b>FINISH</b> SEE PART NUMBER BREAKDOWN	TITLE:	PLUG PROTECTION COVER			 TE connectivity			
PROD APPR		GENERAL TOL LINEAR +/- 0,25MM ANGULAR +/- 1°			ASSY USED ON:	MIL-DTL-5015						
QUAL APPR		ISSUE	REV.	DCR	THIS DRAWING IS COPYRIGHT AND THE PROPERTY OF POLAMCO LTD IT MUST NOT BE COPIED, USED FOR MANUFACTURE OR OTHERWISE DISCLOSED WITHOUT PRIOR WRITTEN CONSENT OF THE COMPANY.			POLAMCO LTD, WESTON LOCK, LOWER BRISTOL ROAD BATH BA2 1EP	SHT	2	DRAWING NO:	P12066
		AA		7332	NCAGE CODE U5792			WEIGHT				