

While TE Connectivity (TE) has made every reasonable effort to ensure the accuracy of the information in the catalog, TE does not guarantee that it is error free, nor does TE make any other representation, warranty or guarantee that information is accurate, correct, reliable or current. TE reserves the right to make any adjustments to the information contained herein at any time without notice. TE expressly disclaims all implied warranties regarding the information contained herein, including, but not limited to, any implied warranties of merchantability or fitness for a particular purpose. The dimensions in this catalog are for reference purpose only and are subject to change without notice. Specifications are subject to change without notice. Consult TE for the latest dimensions and design specifications.

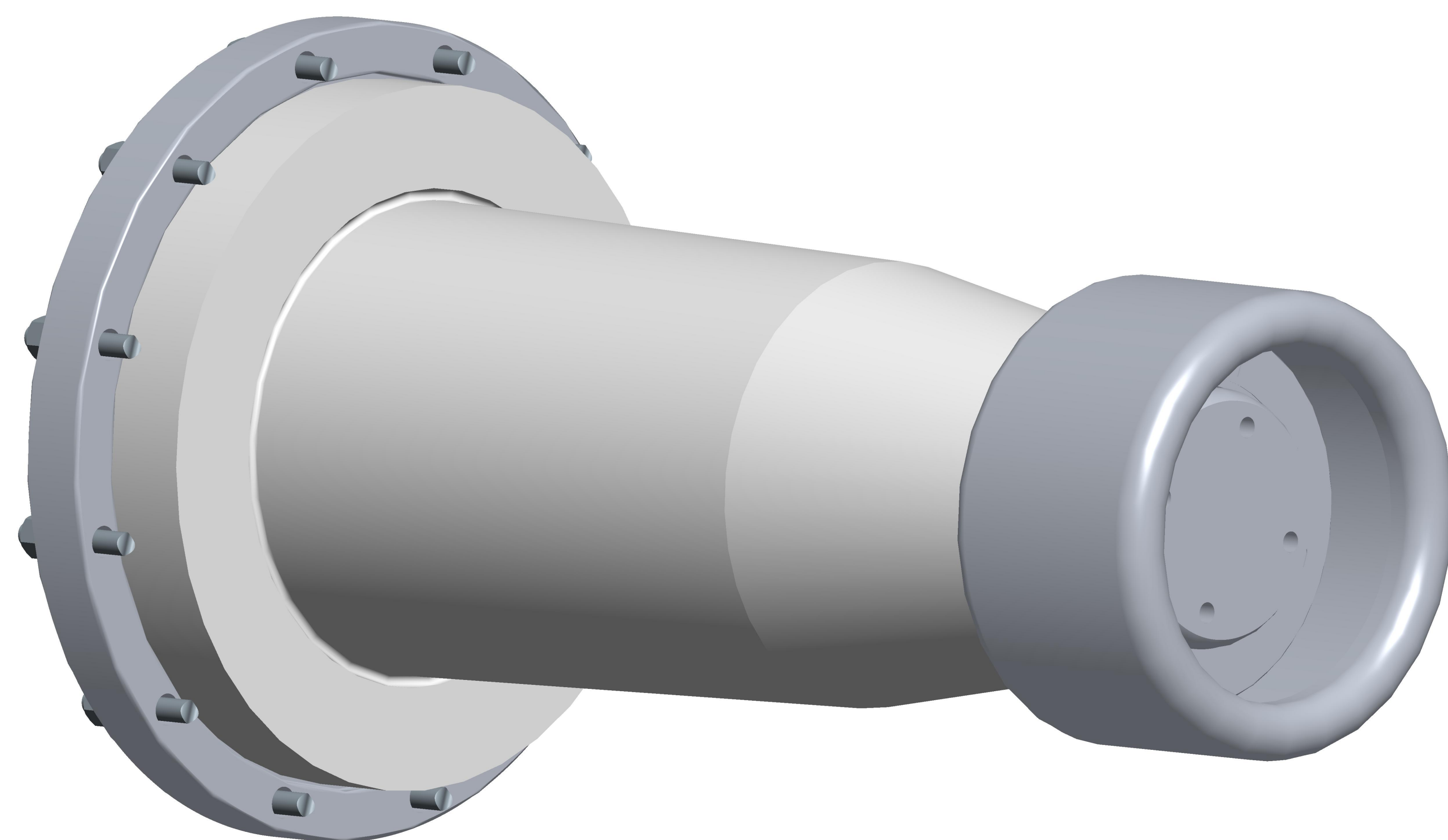
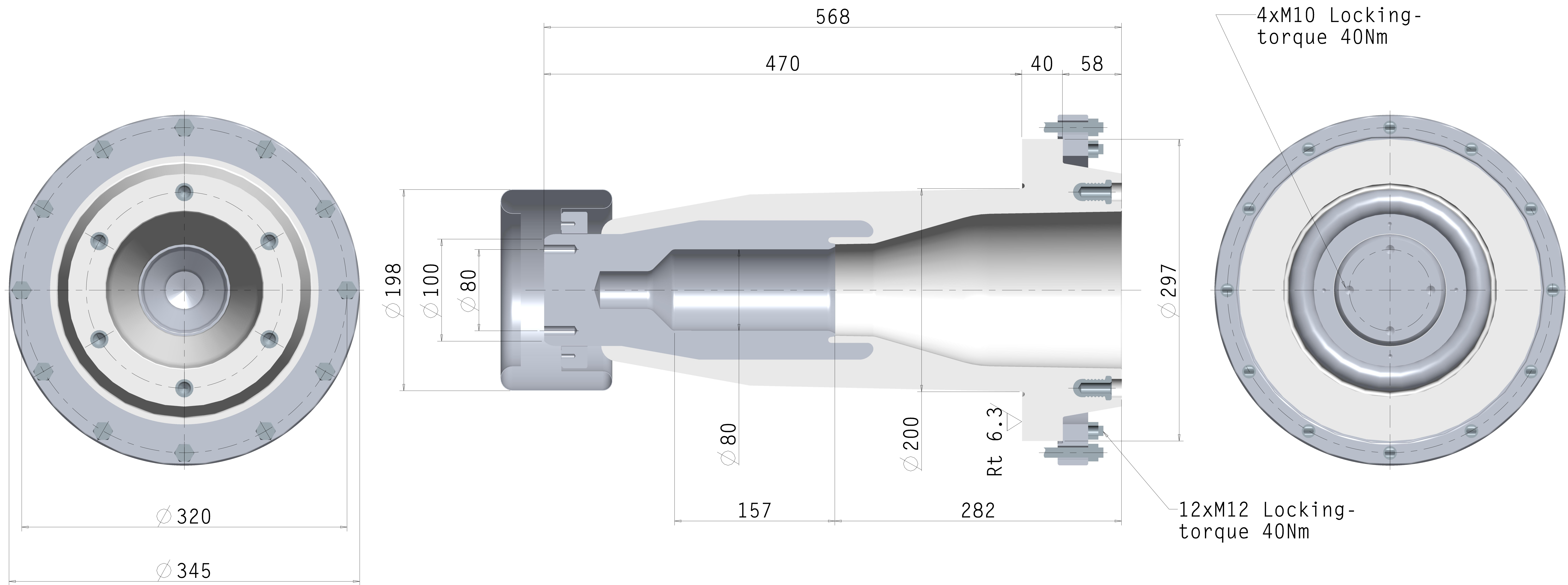

Insulator design according to IEC 62271-209

TRANSFORMER TERMINATION
170 kV DRY TYPE

PHVT-170-INS-SIZE 1
OFFER DRAWING



Raychem High Voltage Cable Accessories

TE Connectivity drawing no: EPD-204-2106-00 REV. 1