

P	LTR	DESCRIPTION	DATE	DWN	APVD
	A	INITIAL DRAWING	13AUG2019	VM	TN

### Ordering Information

Typical Part Number ▶

**WD 5051 -002**

- 1. Basic Series:**  
WD = DIN mount Protective Relay.
- 2. Type:**  
5051 = Single Phase Overcurrent Relay.  
5051-3 = Three Phase Overcurrent Relay.
- 3. Control Voltage:**  
001 = 18 to 54VDC  
002 = 13.5 to 32 VDC  
003 = 100-200VDC Or 100-140VAC.

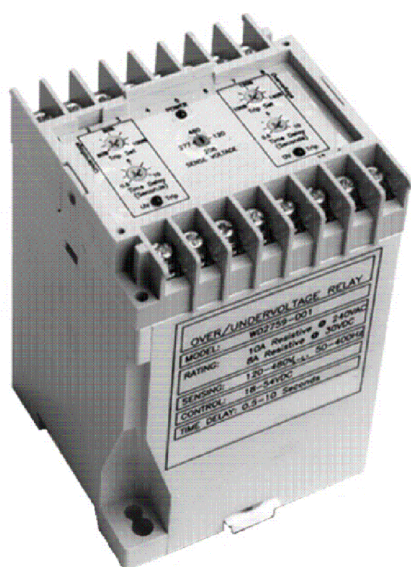

Our authorized distributors are more likely to stock these items.

- WD5051-001
- WD5051-003
- WD5051-3-001

### WD5051 Controls

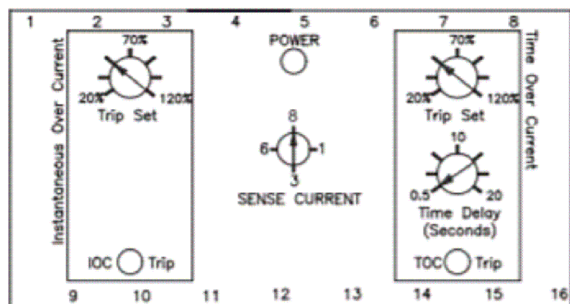

### Outline Dimensions

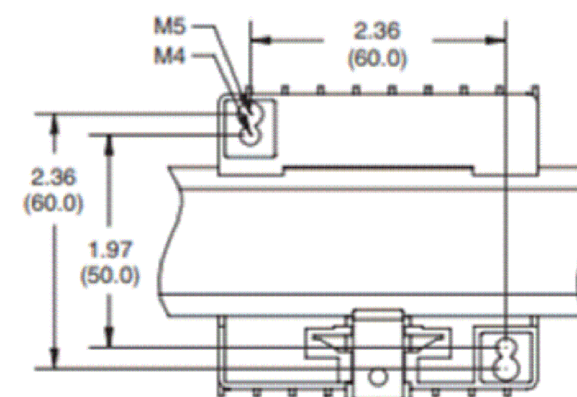
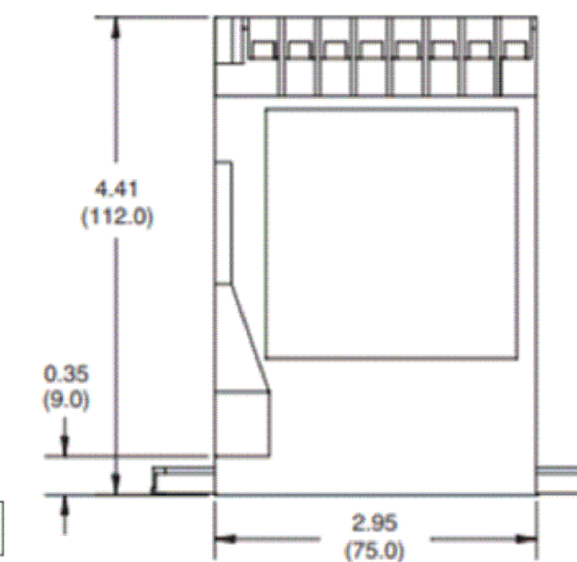
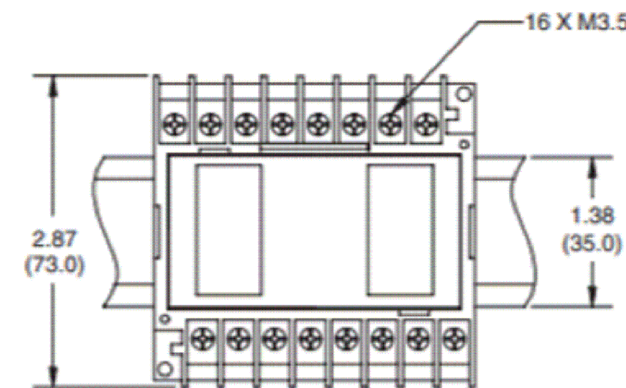

### WD5051 Connections

#### WD5051 Single Phase Model

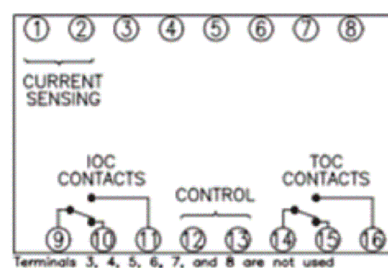

#### WD5051-3 Three Phase Model

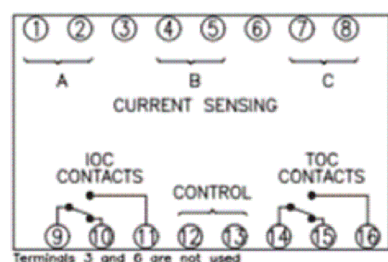

### WD5051 Typical Hookup

#### WD5051 Single Phase Model

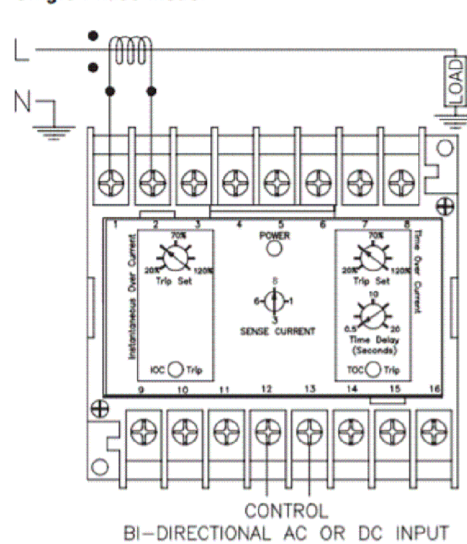

#### WD5051-3 Three Phase Model

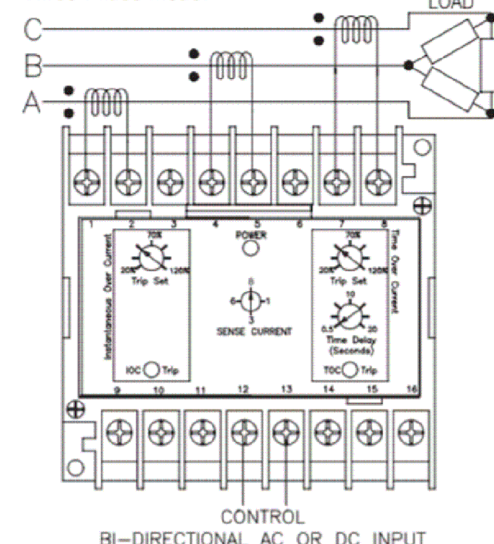

ALL DIMENSIONS ARE IN INCHES(mm)

THIS DRAWING IS A CONTROLLED DOCUMENT.		DWN	13AUG2019	<b>STE</b> TE Connectivity	
		VM			
		CHK	13AUG2019	NAME WD5051 RELAY, OVER CURRENT	
		RV			
		APVD	13AUG2019	SIZE A3	
		TN			
		PRODUCT SPEC		CAGE CODE -	
		APPLICATION SPEC			
		WEIGHT -		DRAWING NO G-WD5051-SERIES	
		CUSTOMER DRAWING			
DIMENSIONS: INCHES		TOLERANCES UNLESS OTHERWISE SPECIFIED:		RESTRICTED TO -	
		0 PLC	± -	SCALE NTS	
		1 PLC	± -		
		2 PLC	± -		
		3 PLC	± -		
		4 PLC	± -		
MATERIAL -		FINISH -		SHEET 1 OF 1	
				REV A	