

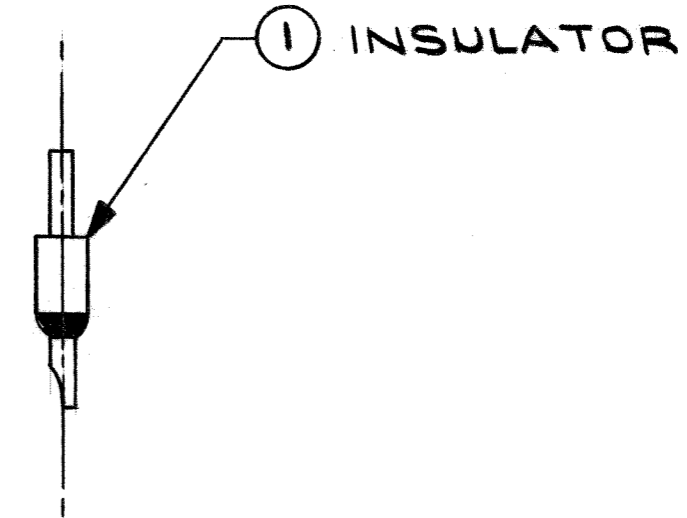

REVISIONS					
ZONE	LTR	ECO	DESCRIPTION	DATE	APPROVED
	A	21910	RELEASE FOR PRODUCTION	3-8-77	<i>[Signature]</i>
	B	22159	DIM: 15; .140 MAX, WAS; .087 ± .020 ⁸	5-26-77	<i>[Signature]</i>
	C	24602	DESCRIPTION WAS MCS**1**SS ¹⁰	2-13-80	<i>[Signature]</i>

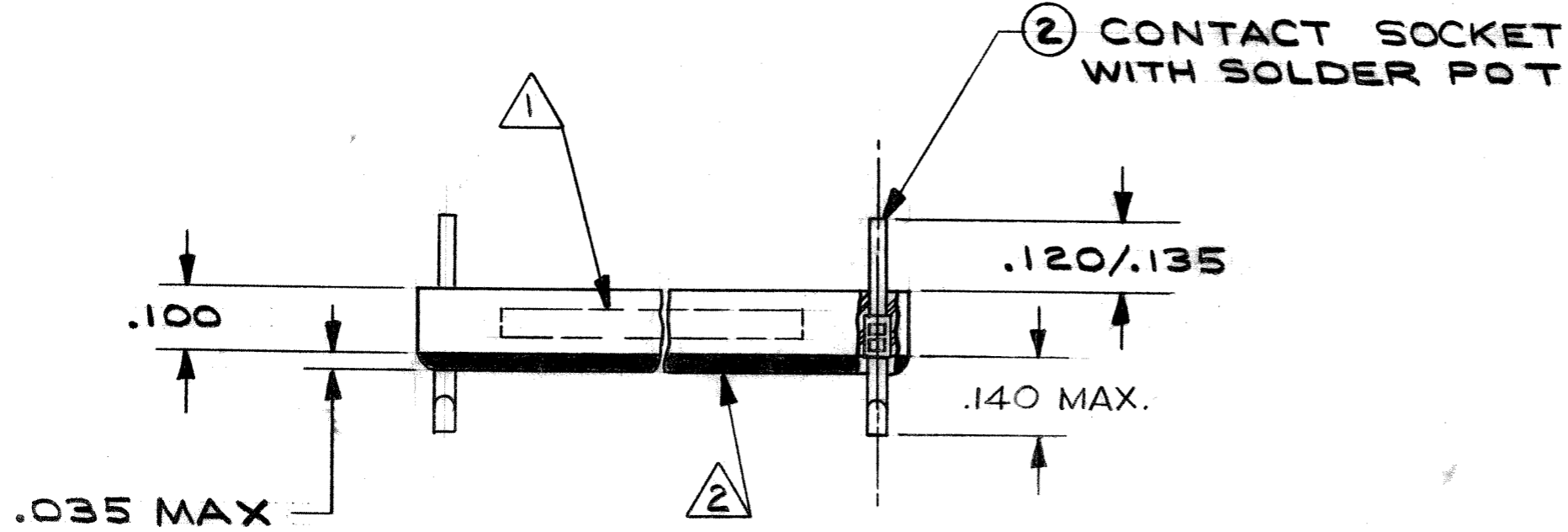
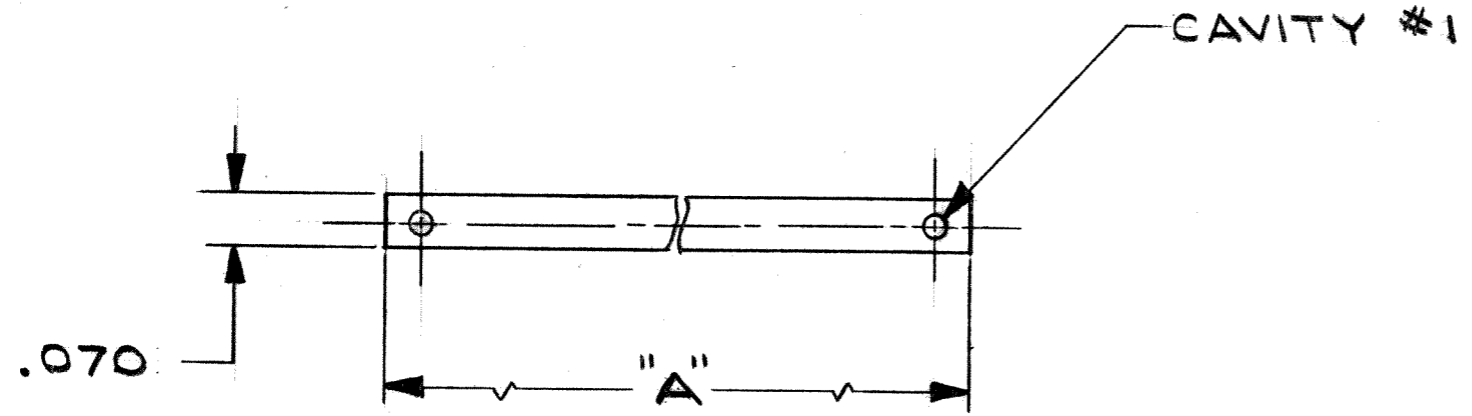

NOTES :

- ① MARK "MALCO" OR MALCO'S LOGO, PART NO. AND DATE CODE .046 MIN. HIGH ON 12 TO 120 CAVITIES, MARK MALCO'S LOGO AND DATE CODE 3 TO 11 CAVITIES.
- ② EPOXY AS SHOWN USING HYSOL # 4215 AND # 3561.

Tyco Dwg 4-1532143-1
Micro P/N 095-0000-0431

QTY.	PT. NO.	DESCRIPTION	ITEM NO.
PARTS LIST			
UNLESS OTHERWISE SPECIFIED DIMENSIONS ARE IN INCHES TOLERANCES ARE: FRACTIONS DECIMALS ANGLES ± .XX ± ± .XXX ± .005		CONTRACT NO.	
MATERIAL		APPROVALS	DATE
FINISH		DRAWN E. MINGURA	3/2/77
NEXT ASSY		CHECKED C. E. HARTRICK	3/3/77
USED ON		PR. ENG. P. White	3/4/77
APPLICATION		APPROVED	
DO NOT SCALE DRAWING		 MALCO A MICRODOT COMPANY, INC. 220 PASADENA AVE., SO. PASADENA, CALIF. 91030	
		STRIP CONNECTOR, RECEPT. WITH CONTACT SOLDER POT MCSA*1-**SS	
		SIZE B	CODE IDENT NO. 98278
		DRAWING NO. 095-0000-0431	
		SCALE 4/1	SHEET 1 OF 1
		<small>These drawings and specifications are the property of Microdot Inc. are issued in strict confidence and shall not be divulged, be reproduced or copied, or used as the basis for the manufacture or sale of any article without written permission of Microdot Inc.</small>	

REVISIONS					
ZONE	LTR	ECO	DESCRIPTION	DATE	APPROVED
	A	21910	RELEASE FOR PRODUCTION	3-8-77	<i>[Signature]</i>
	B	22159	DIM. 15, .140 MAX, WAS .087 ± .020	5-26-77	<i>[Signature]</i>
	C	24602	DESCRIPTION WAS MCS**1**SSD	2-13-86	<i>[Signature]</i>

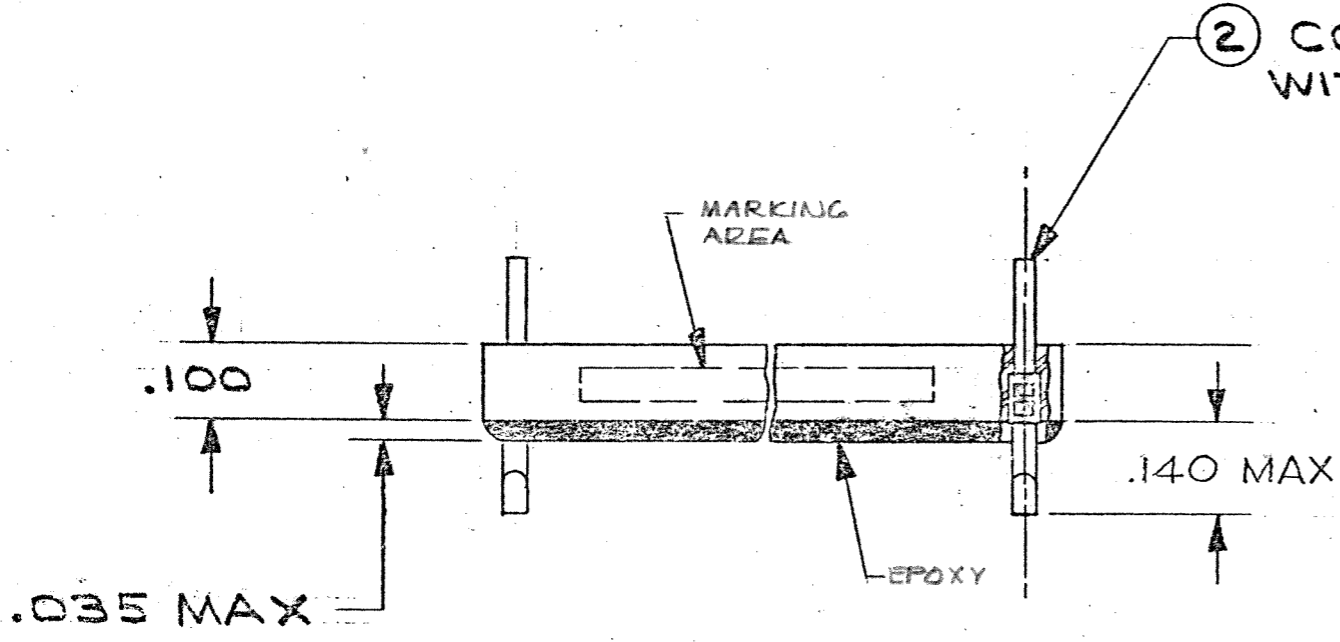
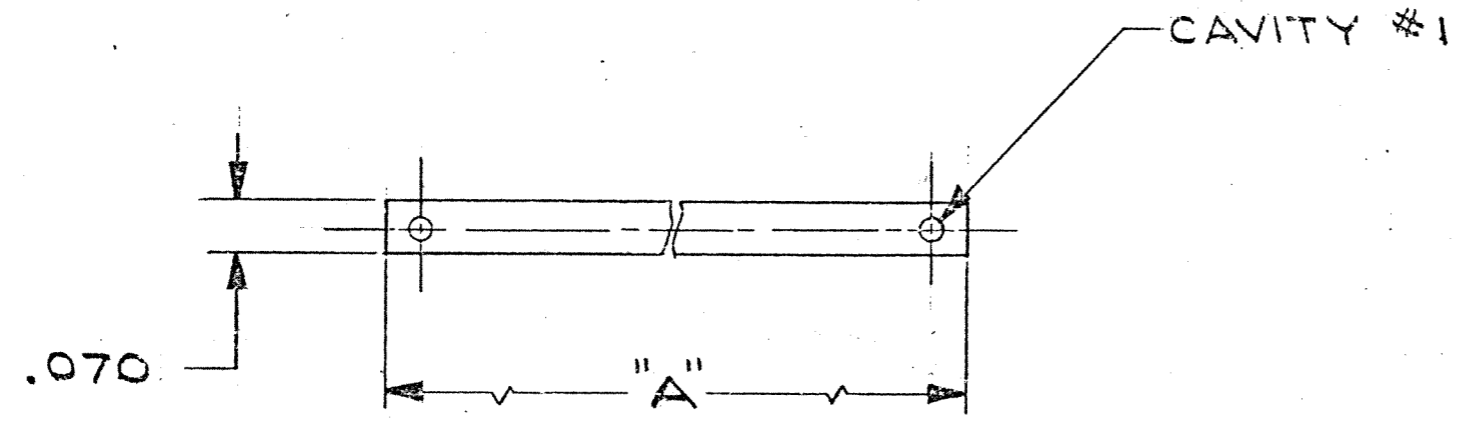

4-1532143-1

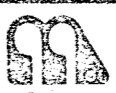
QTY.	PT. NO.	DESCRIPTION	ITEM NO.
PARTS LIST			
UNLESS OTHERWISE SPECIFIED DIMENSIONS ARE IN INCHES TOLERANCES ARE: FRACTIONS DECIMALS ANGLES ± .XX ± ± ± .XXX ± .005		CONTRACT NO.	
MATERIAL		APPROVALS	DATE
FINISH		DRAWN	DATE
NEXT ASSY		CHECKED	DATE
USED ON		PR. ENG.	DATE
APPLICATION		APPROVED	
DO NOT SCALE DRAWING		 MALCO A MICRODOT COMPANY, INC. 220 PASADENA AVE., SO. PASADENA, CALIF. 91030	
		STRIP CONNECTOR, RECEPT. WITH CONTACT SOLDER POT MCSA*1-***SS	
		SIZE	CODE IDENT NO. DRAWING NO.
		B	98278 095-0000-0431
		SCALE	SHEET 1 OF 1
		4/1	