

THIS DRAWING IS UNPUBLISHED. RELEASED FOR PUBLICATION JUN ,2014.
 © COPYRIGHT 2008 TE Connectivity Ltd. ALL RIGHTS RESERVED.

REVISIONS 変更				
P	LTR	DESCRIPTION	DATE	APVD
	B	REVISED PER ECO-19-008840	26NOV2019	SC D.Z

- ① 取付穴寸法
 - ② 適応基板厚: 1.6t
 - ③ かん合相手製品型番:
プラグハウジング: SEE TABLE
 - ④ 青色については色むらが出る可能性があります。
- RECOMMENDED P.C.B LAY OUT
 APPLICABLE P.C.B. THICKNESS: 1.6
 MATING CONN. P/N
 PLUG HOUSING: SEE TABLE
 UNEVEN COLORING MAY COME OUT OF BLUE.

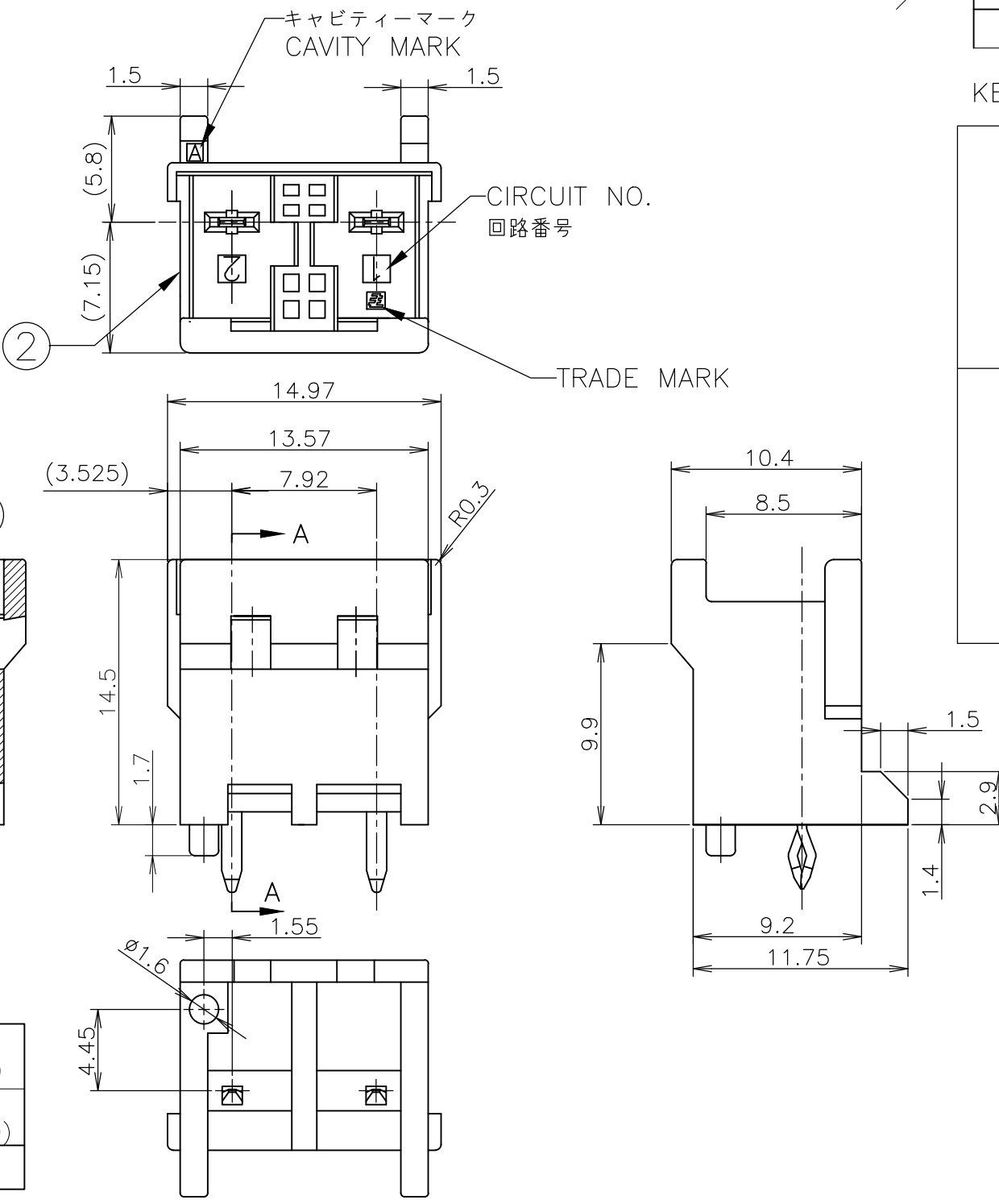

KEYING TYPE

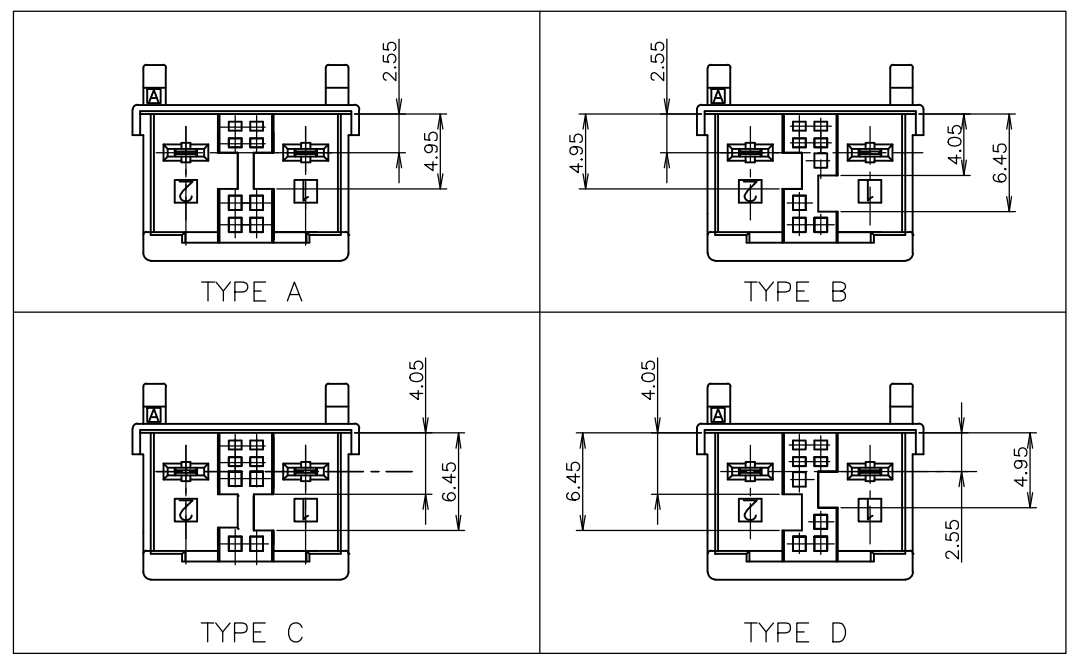

②	ヘッダーハウジング (HEADER HOUSING)	6/6ナイロンガラス強化 (6/6 NYLON GRASS FILLED)
①	タブ (TAB)	錫めっき仕様 銅合金 (COPPER ALLOY TIN PLATED)
NO.	名称 (NAME)	材料 (MATERIAL)

パンチ加工 (PUNCHED HOLE)	1.25
ドリル加工 (DRILLED HOLE)	1.4
	A 寸法

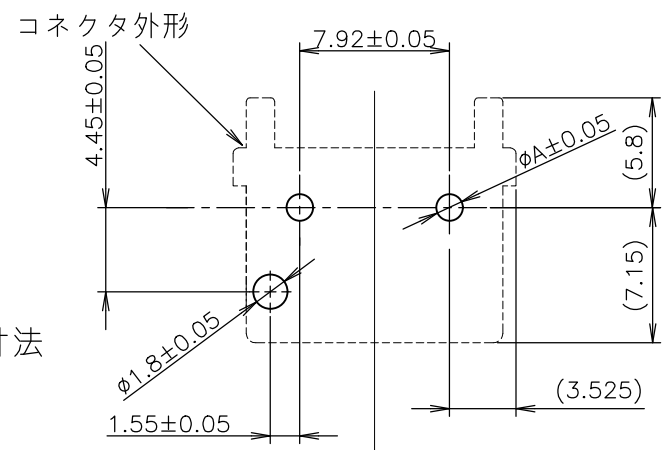







プリント基板推奨穴加工寸法

THIS DRAWING IS A CONTROLLED DOCUMENT.		DWN OTTO CHEN 19JUN2014	STE TE Connectivity Ltd.
DIMENSIONS: 単位: 耗 mm		CHK ALEX ZHANG 19JUN2014	
TOLERANCES UNLESS OTHERWISE SPECIFIED: 一般公差		APVD D.ZHANG 19JUN2014	NAME 名称 GRACE INERTIA CONNECTOR 7.92MM PITCH HEADER ASSEMBLY 2P BOSS-2
0 PLC ± 0.3 1 PLC ± 0.3 2 PLC ± 0.3 3 PLC ± 0.2 4 PLC ± - ANGLES ± 2°		PRODUCT SPEC 製品規格 108-5990	SIZE A3
MATERIAL 材料 SEE TABLE		FINISH 仕上	CAGE CODE 00779
		WEIGHT	DRAWING NO 番号 G-2232784
CUSTOMER DRAWING		RESTRICTED TO	SCALE 尺度 NA
			SHEET 1 OF 2
			REV B

THIS DRAWING IS UNPUBLISHED. RELEASED FOR PUBLICATION JUN , 2014.
 © COPYRIGHT 2008 TE Connectivity Ltd. ALL RIGHTS RESERVED.

REVISIONS 変更					
P	LTR	DESCRIPTION	DATE	DWN	APVD
	-	SEE SHEET 1	-	-	-

3-1747050-5	キンク有 WITH KINK	TYPE D	緑色 GREEN	2極 2POS	3-2232784-5
3-1747050-4	キンク有 WITH KINK	TYPE D	黄色 YELLOW	2極 2POS	3-2232784-4
3-1747050-3	キンク有 WITH KINK	TYPE D	青色 BLUE 	2極 2POS	3-2232784-3
3-1747050-2	キンク有 WITH KINK	TYPE D	赤色 RED	2極 2POS	3-2232784-2
3-1747050-1	キンク有 WITH KINK	TYPE D	自然色 NATURAL	2極 2POS	3-2232784-1
2-1747050-5	キンク有 WITH KINK	TYPE C	緑色 GREEN	2極 2POS	2-2232784-5
2-1747050-4	キンク有 WITH KINK	TYPE C	黄色 YELLOW	2極 2POS	2-2232784-4
2-1747050-3	キンク有 WITH KINK	TYPE C	青色 BLUE 	2極 2POS	2-2232784-3
2-1747050-2	キンク有 WITH KINK	TYPE C	赤色 RED	2極 2POS	2-2232784-2
2-1747050-1	キンク有 WITH KINK	TYPE C	自然色 NATURAL	2極 2POS	2-2232784-1
1-1747050-5	キンク有 WITH KINK	TYPE B	緑色 GREEN	2極 2POS	1-2232784-5
1-1747050-4	キンク有 WITH KINK	TYPE B	黄色 YELLOW	2極 2POS	1-2232784-4
1-1747050-3	キンク有 WITH KINK	TYPE B	青色 BLUE 	2極 2POS	1-2232784-3
1-1747050-2	キンク有 WITH KINK	TYPE B	赤色 RED	2極 2POS	1-2232784-2
1-1747050-1	キンク有 WITH KINK	TYPE B	自然色 NATURAL	2極 2POS	1-2232784-1
1747050-6	キンク有 WITH KINK	TYPE A	黒色 BLACK	2極 2POS	2232784-6
1747050-5	キンク有 WITH KINK	TYPE A	緑色 GREEN	2極 2POS	2232784-5
1747050-4	キンク有 WITH KINK	TYPE A	黄色 YELLOW	2極 2POS	2232784-4
1747050-3	キンク有 WITH KINK	TYPE A	青色 BLUE 	2極 2POS	2232784-3
1747050-2	キンク有 WITH KINK	TYPE A	赤色 RED	2極 2POS	2232784-2
1747050-1	キンク有 WITH KINK	TYPE A	自然色 NATURAL	2極 2POS	2232784-1
かん合相手(プラグ) P/N MATING CONN. P/N 	キンク有無 WITH/WITHOUT KINK	キーイングタイプ TYPE OF KEYING	色 COLOR	極数 POS	型番 PART NO.

THIS DRAWING IS A CONTROLLED DOCUMENT.		DWN OTTO CHEN 19JUN2014	 TE Connectivity Ltd.		
		CHK ALEX ZHANG 19JUN2014			
DIMENSIONS: 単位: 耗 mm		APVD D.ZHANG 19JUN2014	NAME 名称 GRACE INERTIA CONNECTOR 7.92MM PITCH HEADER ASSEMBLY 2P BOSS-2		
TOLERANCES UNLESS OTHERWISE SPECIFIED: 一般公差		PRODUCT SPEC 製品規格 108-5990	RESTRICTED TO		
0 PLC ± 0.3 1 PLC ± 0.3 2 PLC ± 0.3 3 PLC ± 0.2 4 PLC ± - ANGLES ± 2'		APPLICATION SPEC 取付適用規格	SIZE A3	CAGE CODE 00779	DRAWING NO 番号 C-2232784
MATERIAL 材料 SEE TABLE	FINISH 仕上	WEIGHT	SCALE 尺度 NA		
		CUSTOMER DRAWING		SHEET 2 OF 2	REV B