

P	LTR	DESCRIPTION	DATE	DWN	APVD
	BA	INITIAL DRAWING RELEASE	29NOV2023	DM	AP

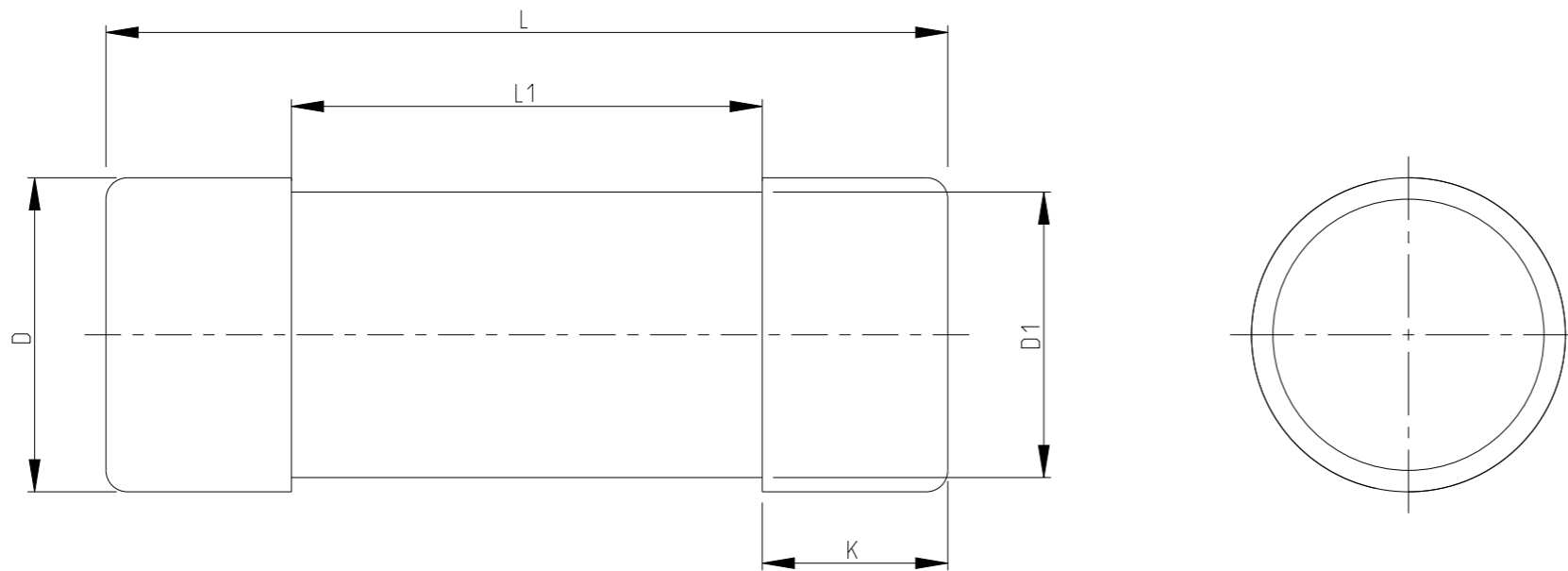

FOR FURTHER INFORMATION SEE DATA SHEET OF METAL FILM PRECISION MELF RESISTOR AEC-Q200 QUALIFIED TYPE SMA-Q SERIES

RECOMMENDED LAND PATTERN

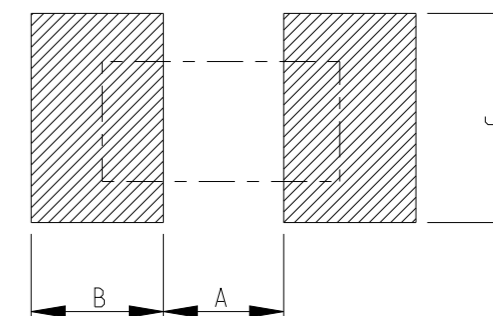

TYPE	L (mm)	L1 min. (mm)	∅D (mm)	∅D1 (mm)	K (mm)	WEIGHT MG EA
SMA-Q 0207	5.9±0.2	2.9	2.2±0.2	D +0/-0.2	1.3±0.1	80.9

SIZE	A (mm)	B (mm)	C (mm)
SMA-Q 0207	3.0	1.7	2.4

RoHS Compliant

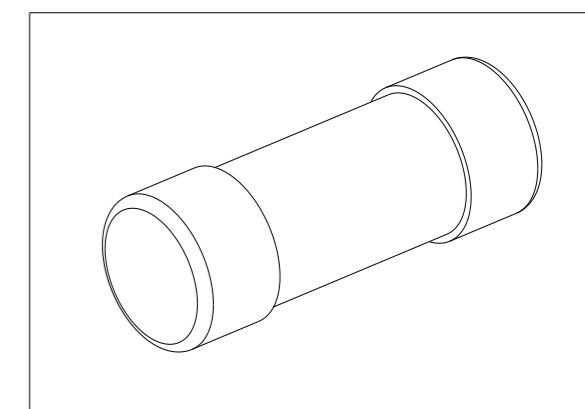

THIS DRAWING IS A CONTROLLED DOCUMENT.		DWN DHEERAJ M 29NOV2023	 TE Connectivity NAME METAL FILM PRECISION MELF RESISTORS AEC-Q200 QUALIFIED TYPE SMA-Q 0207 SERIES					
DIMENSIONS: mm		CHK TRACY G 29NOV2023						
TOLERANCES UNLESS OTHERWISE SPECIFIED:		APVD ALLAN P 29NOV2023						
0 PLC ±0.2 1 PLC ±0.1 2 PLC ± 3 PLC ± 4 PLC ± ANGLES ±5°		PRODUCT SPEC -						
MATERIAL -		FINISH -	APPLICATION SPEC -	WEIGHT -	SIZE A3	CAGE CODE 00779	DRAWING NO C=2176669	RESTRICTED TO -
CUSTOMER DRAWING			SCALE 20:1	SHEET 1 OF 3	REV BA			

REVISIONS

P	LTR	DESCRIPTION	DATE	DWN	APVD
	-	SEE SHEET 1	-	-	-

SCHEDULE			
TCPN	CATALOGUE NUMBER	PART DESCRIPTION	PART STATUS
2176669-1	SMA-Q0207BTCT130K	MELF SMA-Q 130K 0.1% 25PPM 0207 1W	PRODUCTION
2176669-2	SMA-Q0207BTCT133K	MELF SMA-Q 133K 0.1% 25PPM 0207 1W	PRODUCTION
2176669-3	SMA-Q0207BTCT137K	MELF SMA-Q 137K 0.1% 25PPM 0207 1W	PRODUCTION
2176669-4	SMA-Q0207BTCT140K	MELF SMA-Q 140K 0.1% 25PPM 0207 1W	PRODUCTION
2176669-5	SMA-Q0207BTCT143K	MELF SMA-Q 143K 0.1% 25PPM 0207 1W	PRODUCTION
2176669-6	SMA-Q0207BTCT147K	MELF SMA-Q 147K 0.1% 25PPM 0207 1W	PRODUCTION
2176669-7	SMA-Q0207BTCT150K	MELF SMA-Q 150K 0.1% 25PPM 0207 1W	PRODUCTION
2176669-8	SMA-Q0207BTCT154K	MELF SMA-Q 154K 0.1% 25PPM 0207 1W	PRODUCTION
2176669-9	SMA-Q0207BTCT158K	MELF SMA-Q 158K 0.1% 25PPM 0207 1W	PRODUCTION
1-2176669-0	SMA-Q0207BTCT162K	MELF SMA-Q 162K 0.1% 25PPM 0207 1W	PRODUCTION
1-2176669-1	SMA-Q0207BTCT165K	MELF SMA-Q 165K 0.1% 25PPM 0207 1W	PRODUCTION
1-2176669-2	SMA-Q0207BTCT169K	MELF SMA-Q 169K 0.1% 25PPM 0207 1W	PRODUCTION
1-2176669-3	SMA-Q0207BTCT174K	MELF SMA-Q 174K 0.1% 25PPM 0207 1W	PRODUCTION
1-2176669-4	SMA-Q0207BTCT178K	MELF SMA-Q 178K 0.1% 25PPM 0207 1W	PRODUCTION
1-2176669-5	SMA-Q0207BTCT182K	MELF SMA-Q 182K 0.1% 25PPM 0207 1W	PRODUCTION
1-2176669-6	SMA-Q0207BTCT187K	MELF SMA-Q 187K 0.1% 25PPM 0207 1W	PRODUCTION
1-2176669-7	SMA-Q0207BTCT191K	MELF SMA-Q 191K 0.1% 25PPM 0207 1W	PRODUCTION
1-2176669-8	SMA-Q0207BTCT196K	MELF SMA-Q 196K 0.1% 25PPM 0207 1W	PRODUCTION
1-2176669-9	SMA-Q0207BTCT200K	MELF SMA-Q 200K 0.1% 25PPM 0207 1W	PRODUCTION
2-2176669-0	SMA-Q0207BTCT205K	MELF SMA-Q 205K 0.1% 25PPM 0207 1W	PRODUCTION
2-2176669-1	SMA-Q0207BTCT210K	MELF SMA-Q 210K 0.1% 25PPM 0207 1W	PRODUCTION
2-2176669-2	SMA-Q0207BTCT215K	MELF SMA-Q 215K 0.1% 25PPM 0207 1W	PRODUCTION
2-2176669-3	SMA-Q0207BTCT221K	MELF SMA-Q 221K 0.1% 25PPM 0207 1W	PRODUCTION
2-2176669-4	SMA-Q0207BTCT226K	MELF SMA-Q 226K 0.1% 25PPM 0207 1W	PRODUCTION
2-2176669-5	SMA-Q0207BTCT232K	MELF SMA-Q 232K 0.1% 25PPM 0207 1W	PRODUCTION
2-2176669-6	SMA-Q0207BTCT237K	MELF SMA-Q 237K 0.1% 25PPM 0207 1W	PRODUCTION
2-2176669-7	SMA-Q0207BTCT243K	MELF SMA-Q 243K 0.1% 25PPM 0207 1W	PRODUCTION
2-2176669-8	SMA-Q0207BTCT249K	MELF SMA-Q 249K 0.1% 25PPM 0207 1W	PRODUCTION
2-2176669-9	SMA-Q0207BTCT255K	MELF SMA-Q 255K 0.1% 25PPM 0207 1W	PRODUCTION
3-2176669-0	SMA-Q0207BTCT261K	MELF SMA-Q 261K 0.1% 25PPM 0207 1W	PRODUCTION
3-2176669-1	SMA-Q0207BTCT267K	MELF SMA-Q 267K 0.1% 25PPM 0207 1W	PRODUCTION
3-2176669-2	SMA-Q0207BTCT274K	MELF SMA-Q 274K 0.1% 25PPM 0207 1W	PRODUCTION
3-2176669-3	SMA-Q0207BTCT280K	MELF SMA-Q 280K 0.1% 25PPM 0207 1W	PRODUCTION

SCHEDULE			
TCPN	CATALOGUE NUMBER	PART DESCRIPTION	PART STATUS
3-2176669-4	SMA-Q0207BTCT287K	MELF SMA-Q 287K 0.1% 25PPM 0207 1W	PRODUCTION
3-2176669-5	SMA-Q0207BTCT294K	MELF SMA-Q 294K 0.1% 25PPM 0207 1W	PRODUCTION
3-2176669-6	SMA-Q0207BTCT301K	MELF SMA-Q 301K 0.1% 25PPM 0207 1W	PRODUCTION
3-2176669-7	SMA-Q0207BTCT309K	MELF SMA-Q 309K 0.1% 25PPM 0207 1W	PRODUCTION
3-2176669-8	SMA-Q0207BTCT316K	MELF SMA-Q 316K 0.1% 25PPM 0207 1W	PRODUCTION
3-2176669-9	SMA-Q0207BTCT324K	MELF SMA-Q 324K 0.1% 25PPM 0207 1W	PRODUCTION
4-2176669-0	SMA-Q0207BTCT332K	MELF SMA-Q 332K 0.1% 25PPM 0207 1W	PRODUCTION
4-2176669-1	SMA-Q0207BTCT340K	MELF SMA-Q 340K 0.1% 25PPM 0207 1W	PRODUCTION
4-2176669-2	SMA-Q0207BTCT348K	MELF SMA-Q 348K 0.1% 25PPM 0207 1W	PRODUCTION
4-2176669-3	SMA-Q0207BTCT357K	MELF SMA-Q 357K 0.1% 25PPM 0207 1W	PRODUCTION
4-2176669-4	SMA-Q0207BTCT365K	MELF SMA-Q 365K 0.1% 25PPM 0207 1W	PRODUCTION
4-2176669-5	SMA-Q0207BTCT374K	MELF SMA-Q 374K 0.1% 25PPM 0207 1W	PRODUCTION
4-2176669-6	SMA-Q0207BTCT383K	MELF SMA-Q 383K 0.1% 25PPM 0207 1W	PRODUCTION
4-2176669-7	SMA-Q0207BTCT392K	MELF SMA-Q 392K 0.1% 25PPM 0207 1W	PRODUCTION
4-2176669-8	SMA-Q0207BTCT402K	MELF SMA-Q 402K 0.1% 25PPM 0207 1W	PRODUCTION
4-2176669-9	SMA-Q0207BTCT412K	MELF SMA-Q 412K 0.1% 25PPM 0207 1W	PRODUCTION
5-2176669-0	SMA-Q0207BTCT422K	MELF SMA-Q 422K 0.1% 25PPM 0207 1W	PRODUCTION
5-2176669-1	SMA-Q0207BTCT432K	MELF SMA-Q 432K 0.1% 25PPM 0207 1W	PRODUCTION
5-2176669-2	SMA-Q0207BTCT442K	MELF SMA-Q 442K 0.1% 25PPM 0207 1W	PRODUCTION
5-2176669-3	SMA-Q0207BTCT453K	MELF SMA-Q 453K 0.1% 25PPM 0207 1W	PRODUCTION
5-2176669-4	SMA-Q0207BTCT464K	MELF SMA-Q 464K 0.1% 25PPM 0207 1W	PRODUCTION
5-2176669-5	SMA-Q0207BTCT475K	MELF SMA-Q 475K 0.1% 25PPM 0207 1W	PRODUCTION
5-2176669-6	SMA-Q0207BTCT487K	MELF SMA-Q 487K 0.1% 25PPM 0207 1W	PRODUCTION
5-2176669-7	SMA-Q0207BTCT499K	MELF SMA-Q 499K 0.1% 25PPM 0207 1W	PRODUCTION
5-2176669-8	SMA-Q0207BTCT511K	MELF SMA-Q 511K 0.1% 25PPM 0207 1W	PRODUCTION
5-2176669-9	SMA-Q0207BTCT523K	MELF SMA-Q 523K 0.1% 25PPM 0207 1W	PRODUCTION
6-2176669-0	SMA-Q0207BTCT536K	MELF SMA-Q 536K 0.1% 25PPM 0207 1W	PRODUCTION
6-2176669-1	SMA-Q0207BTCT549K	MELF SMA-Q 549K 0.1% 25PPM 0207 1W	PRODUCTION
6-2176669-2	SMA-Q0207BTCT562K	MELF SMA-Q 562K 0.1% 25PPM 0207 1W	PRODUCTION
6-2176669-3	SMA-Q0207BTCT576K	MELF SMA-Q 576K 0.1% 25PPM 0207 1W	PRODUCTION
6-2176669-4	SMA-Q0207BTCT590K	MELF SMA-Q 590K 0.1% 25PPM 0207 1W	PRODUCTION
6-2176669-5	SMA-Q0207BTCT604K	MELF SMA-Q 604K 0.1% 25PPM 0207 1W	PRODUCTION
6-2176669-6	SMA-Q0207BTCT619K	MELF SMA-Q 619K 0.1% 25PPM 0207 1W	PRODUCTION

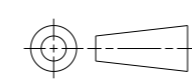
THIS DRAWING IS A CONTROLLED DOCUMENT.		DWN DHEERAJ M 29NOV2023	 TE Connectivity	
		CHK TRACY G 29NOV2023		
DIMENSIONS: mm		APVD ALLAN P 29NOV2023	NAME METAL FILM PRECISION MELF RESISTORS AEC-Q200 QUALIFIED TYPE SMA-Q 0207 SERIES	
		PRODUCT SPEC -	SIZE A3	
TOLERANCES UNLESS OTHERWISE SPECIFIED: 0 PLC ±0.2 1 PLC ±0.1 2 PLC ± 3 PLC ± 4 PLC ± ANGLES ±5°		APPLICATION SPEC -	CAGE CODE 00779	
MATERIAL -		WEIGHT -	DRAWING NO C-2176669	
		CUSTOMER DRAWING		RESTRICTED TO -
		SCALE 20:1		SHEET 2 OF 3 REV BA

REVISIONS

P	LTR	DESCRIPTION	DATE	DWN	APVD
-		SEE SHEET 1	-	-	-

SCHEDULE			
TCPN	CATALOGUE NUMBER	PART DESCRIPTION	PART STATUS
6-2176669-7	SMA-Q0207BTCT634K	MELF SMA-Q 634K 0.1% 25PPM 0207 1W	PRODUCTION
6-2176669-8	SMA-Q0207BTCT649K	MELF SMA-Q 649K 0.1% 25PPM 0207 1W	PRODUCTION
6-2176669-9	SMA-Q0207BTCT665K	MELF SMA-Q 665K 0.1% 25PPM 0207 1W	PRODUCTION
7-2176669-0	SMA-Q0207BTCT681K	MELF SMA-Q 681K 0.1% 25PPM 0207 1W	PRODUCTION
7-2176669-1	SMA-Q0207BTCT698K	MELF SMA-Q 698K 0.1% 25PPM 0207 1W	PRODUCTION
7-2176669-2	SMA-Q0207BTCT715K	MELF SMA-Q 715K 0.1% 25PPM 0207 1W	PRODUCTION
7-2176669-3	SMA-Q0207BTCT732K	MELF SMA-Q 732K 0.1% 25PPM 0207 1W	PRODUCTION
7-2176669-4	SMA-Q0207BTCT750K	MELF SMA-Q 750K 0.1% 25PPM 0207 1W	PRODUCTION
7-2176669-5	SMA-Q0207BTCT768K	MELF SMA-Q 768K 0.1% 25PPM 0207 1W	PRODUCTION
7-2176669-6	SMA-Q0207BTCT787K	MELF SMA-Q 787K 0.1% 25PPM 0207 1W	PRODUCTION
7-2176669-7	SMA-Q0207BTCT806K	MELF SMA-Q 806K 0.1% 25PPM 0207 1W	PRODUCTION
7-2176669-8	SMA-Q0207BTCT825K	MELF SMA-Q 825K 0.1% 25PPM 0207 1W	PRODUCTION
7-2176669-9	SMA-Q0207BTCT845K	MELF SMA-Q 845K 0.1% 25PPM 0207 1W	PRODUCTION
8-2176669-0	SMA-Q0207BTCT866K	MELF SMA-Q 866K 0.1% 25PPM 0207 1W	PRODUCTION
8-2176669-1	SMA-Q0207BTCT887K	MELF SMA-Q 887K 0.1% 25PPM 0207 1W	PRODUCTION
8-2176669-2	SMA-Q0207BTCT909K	MELF SMA-Q 909K 0.1% 25PPM 0207 1W	PRODUCTION
8-2176669-3	SMA-Q0207BTCT931K	MELF SMA-Q 931K 0.1% 25PPM 0207 1W	PRODUCTION
8-2176669-4	SMA-Q0207BTCT953K	MELF SMA-Q 953K 0.1% 25PPM 0207 1W	PRODUCTION
8-2176669-5	SMA-Q0207BTCT976K	MELF SMA-Q 976K 0.1% 25PPM 0207 1W	PRODUCTION
8-2176669-6	SMA-Q0207BTCT1M0	MELF SMA-Q 1M0 0.1% 25PPM 0207 1W	PRODUCTION

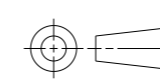
THIS DRAWING IS A CONTROLLED DOCUMENT.		DWN DHEERAJ M 29NOV2023	 TE Connectivity	
		CHK TRACY G 29NOV2023		
DIMENSIONS: mm		APVD ALLAN P 29NOV2023	NAME METAL FILM PRECISION MELF RESISTORS AEC-Q200 QUALIFIED TYPE SMA-Q 0207 SERIES	
		PRODUCT SPEC -	RESTRICTED TO -	
TOLERANCES UNLESS OTHERWISE SPECIFIED: 0 PLC ±0.2 1 PLC ±0.1 2 PLC ±- 3 PLC ±- 4 PLC ±- ANGLES ±5°		APPLICATION SPEC -	SIZE A3	CAGE CODE 00779
MATERIAL -		WEIGHT -	DRAWING NO C=2176669	SCALE 20:1
		CUSTOMER DRAWING		SHEET 3 OF 3
				REV BA