

THIS DRAWING IS UNPUBLISHED.

RELEASED FOR PUBLICATION

ALL RIGHTS RESERVED.

© COPYRIGHT - By -

REVISIONS

P	LTR	DESCRIPTION	DATE	DWN	APVD
	B2	REVISED	ECR-18-009736	22JUN2018	TS HY

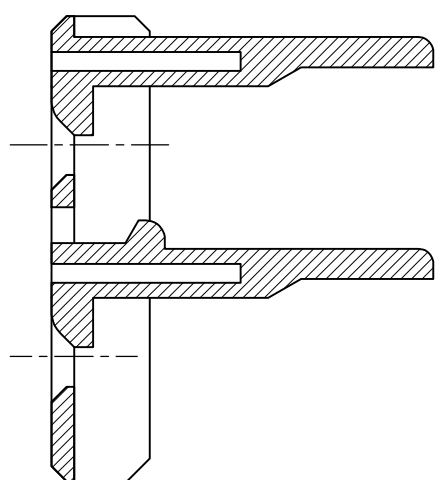
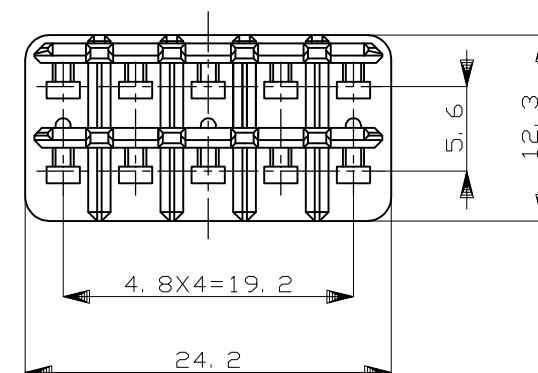
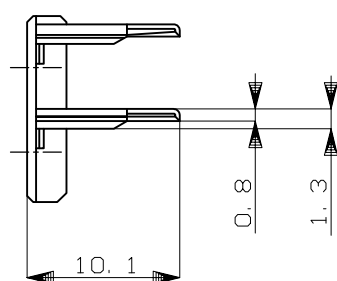
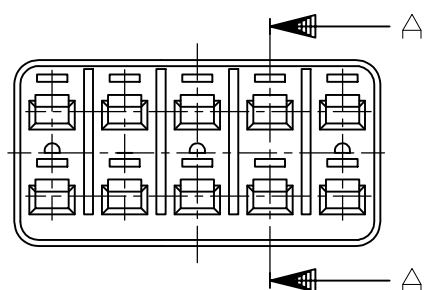
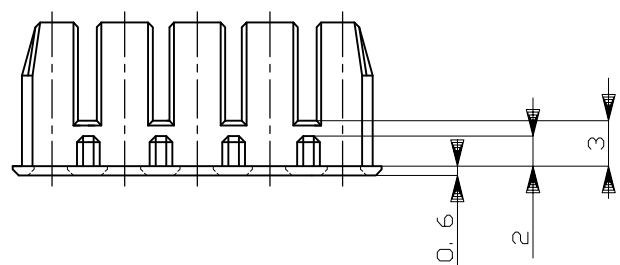

SECTION
断面 A-A
(尺度 5:1)

1. 本品は、プラグハウジング型番 174655及び 2822395に装着される

1. TO BE MATED WITH PLUG HOUSING PART NUMBER 174655 AND 2822395

HB	自然色 (NATURAL)	1-174656-1
V-2	黄 (YELLOW)	174656-7
使用材料難燃グレード (FLAMMABILITY OF MATERIAL)	色 (COLOR)	型番 (PART NUMBER)

GENERAL TOLERANCE

0 < * ≤ 10	: ±0.2
10 < * ≤ 30	: ±0.25
30 < * ≤ 100	: ±0.3
ANGLES	: ±3°

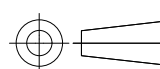
THIS DRAWING IS A CONTROLLED DOCUMENT.		DWN K.ODA	7/7'87	 TE Connectivity Ltd.		
DIMENSIONS: mm		CHK Y.MATSUSAKA	7/9'87			
		TOLERANCES UNLESS OTHERWISE SPECIFIED:		NAME		
		0 PLC ± -	1 PLC ± -	10P. ECONOSEAL J-MARKII+ CONNECTOR DOUBLE LOCK PLATE FOR PLUG HOUSING		
MATERIAL PBT		2 PLC ± -	3 PLC ± -	APPLICATION SPEC		
		4 PLC ± -	ANGLES ± -	FINISH		
		FINISH		RESTRICTED TO		
		MATERIAL		WEIGHT	0.8 g	
		FINISH		CUSTOMER DRAWING		
		FINISH		SCALE	5:1	
		FINISH		SHEET	1 OF 1	
		FINISH		REV	B2	
		FINISH		SIZE CAGE CODE DRAWING NO		
		FINISH		A3 174656 C-174656		