

REVISIONS

P	LTR	DESCRIPTION	DATE	DWN	APVD
	BA	NEW RELEASE	23-MAR-10	MRS	St.P
	BB	CLARIFICATION OF DIMENSIONS	18JAN2023	DM	AP

FOR FURTHER INFORMATION SEE DATA SHEET FOR SERIES LR, METAL FILM FIXED RESISTORS

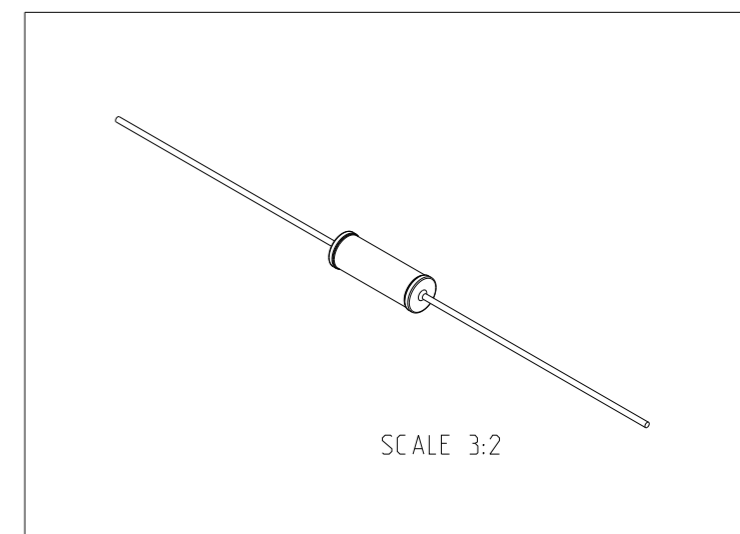
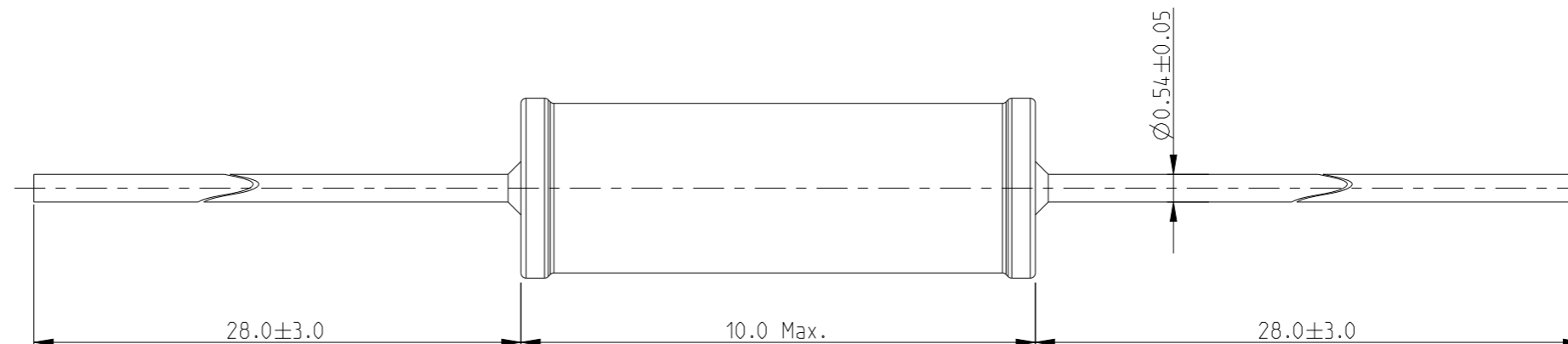

RoHS Compliant

THIS DRAWING IS A CONTROLLED DOCUMENT.

DWN 23-MAR-10 MAHARUDRA

CHK 23-MAR-10 ALLAN.P

APVD 23-MAR-10 STEPHEN.P

PRODUCT SPEC -

APPLICATION SPEC -

WEIGHT -

CUSTOMER DRAWING

NAME METAL FILM FIXED RESISTORS SERIES LR2



SIZE	CAGE CODE	DRAWING NO	RESTRICTED TO
------	-----------	------------	---------------

A3	00779	C=1622752	-
----	-------	-----------	---

SCALE 8:1	SHEET 1 OF 1	REV BB
-----------	--------------	--------

DIMENSIONS:		TOLERANCES UNLESS OTHERWISE SPECIFIED:	
mm		0 PLC	±0.2
		1 PLC	±0.1
		2 PLC	±
		3 PLC	±
		4 PLC	±
MATERIAL		ANGLES	±5°
-		FINISH	-