

THIS DRAWING IS UNPUBLISHED. RELEASED FOR PUBLICATION AUG ,2006.
 © COPYRIGHT BY TYCO ELECTRONICS CORPORATION. ALL RIGHTS RESERVED.

LOC	DIST	REVISIONS					
DW		P	LTR	DESCRIPTION	DATE	DWN	APVD
		C1		REVISED (ECR-08-011953)	12MAY08	SC	WK

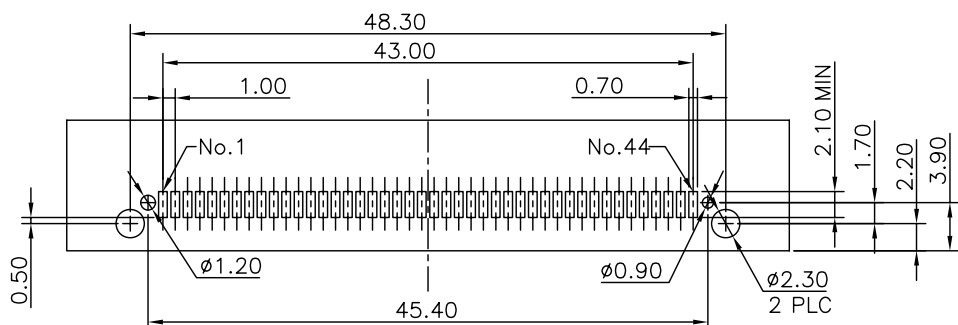
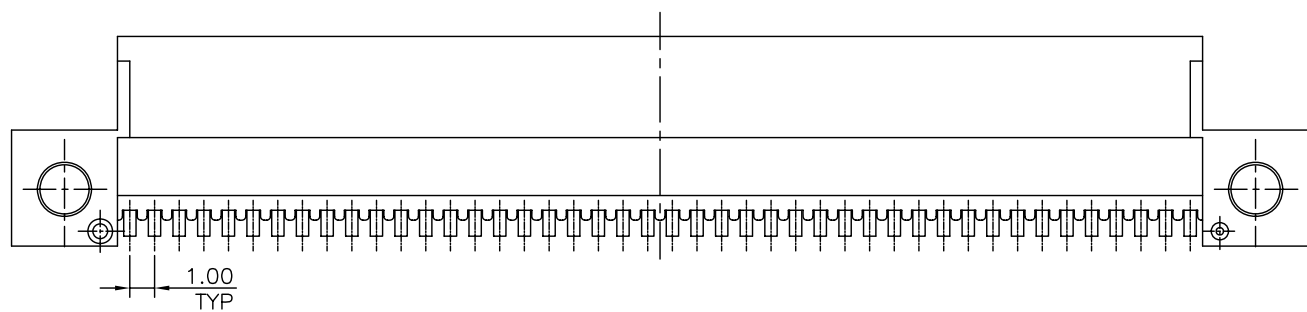
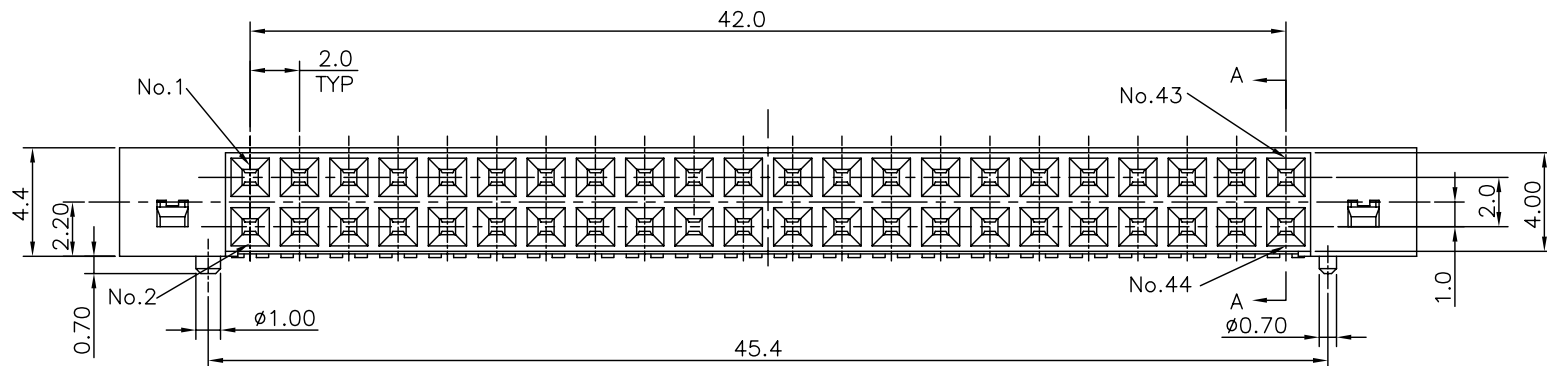
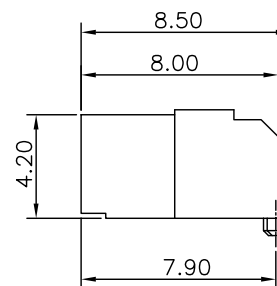
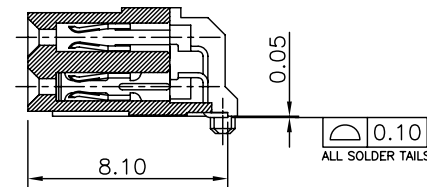
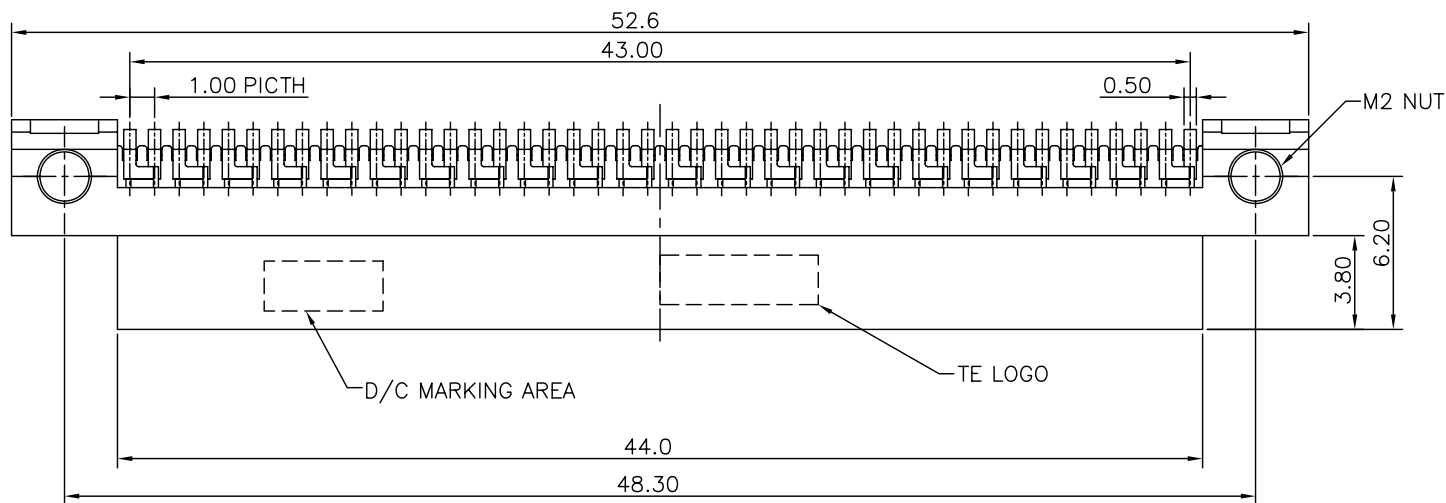

RECOMMENDED PCB LAYOUT (TOLERANCE: ±0.05)
 THICKNESS=1.20mm

NOTES:

- MATERIAL
 HOUSING: HIGH TEMP. THERMOPLASTIC, UL94V-0, BLACK COLOR.
 CONTACT: PHOSPHOR BRONZE, T=0.20mm.
 NUT: SUS 430.
- FINISH:
 CONTACT: GOLD PLATING ON CONTACT AREA,
 2.032μm [80μ"] MIN. TIN(MATTE) PLATED ON SOLDER TAILS,
 1.27μm [50μ"] MIN. NICKEL UNDERPLATED ALL OVER.
- RECOMMENDED TIGHTENING TORQUE: 0.15~0.2N·m(1.5~2Kgf·cm)

GOLD FLASH	1470492-2
8u" MIN.	1470492-1
GOLD PLATING	PART NUMBER

THIS DRAWING IS A CONTROLLED DOCUMENT.		DWN S. CHIEN 12MAY2008	Tyco Electronics Corporation Typei, Taiwan	
DIMENSIONS: MM		CHK W. KODAMA 12MAY2008	NAME	
TOLERANCES UNLESS OTHERWISE SPECIFIED:		APVD W. KODAMA 12MAY2008	2.0 PITCH MODU REC ASS'Y, 44P RIGHT ANGLE, STANDOFF 2.2MM CENTER HEIGHT, SMT TYPE.	
0 PLC ± 0.3		PRODUCT SPEC	SIZE CAGE CODE DRAWING NO RESTRICTED TO	
1 PLC ± 0.3		108-57805	A3 00779 C-1470492	
2 PLC ± 0.3		QUALIFICATION TEST REPORT	WEIGHT 2.20 GRAMS	
3 PLC ± 0.3		501-57811	CUSTOMER DRAWING	
4 PLC ± 0.3		FINISH	SCALE SHEET 1 of 2 REV C1	
ANGLES ± 3'		SEE NOTE		
MATERIAL SEE NOTE				

4

3

2

1

THIS DRAWING IS UNPUBLISHED.

RELEASED FOR PUBLICATION

AUG ,2006.

© COPYRIGHT - BY TYCO ELECTRONICS CORPORATION. ALL RIGHTS RESERVED.

LOC

DIST

REVISIONS

DW

P

LTR

DESCRIPTION

DATE

DWN

APVD

SEE SHEET 1.

NOTES :

- 1. MATERIAL :
 - 1.1 TRAY : PS
 - 1.2 SHIPPING CARTON : CORRUGATED FIBERBOARD
 - 1.3 FOLDER: SINGLE WALL CORRUGATED.
- 2. DIMENSION :
 - 2.1 TRAY : L=305, W=203, H=8.9
 - 2.2 CARTON : L=310, W=215, H=130(INNER DIM)
 - 2.3 FOLDER : L=647, W=303, T=3
- 3. QUANTITY :
 - 3.1 PRIMARY PACKING: 40 PCS/TRAY
 - 3.2 SECONARY PACKING: 15 TRAY/CARTON(600PCS)
- 4. WEIGHT :
 - 4.1 NET WEIGHT : 1.32Kg/CARTON
 - 4.2 GROSS WEIGHT : 3.1Kg/CARTON

D

D

C

C

B

B

A

A

TOTAL 15 TRAY

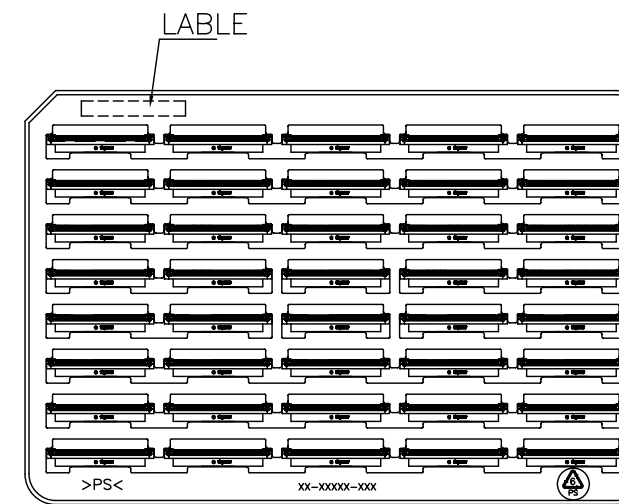
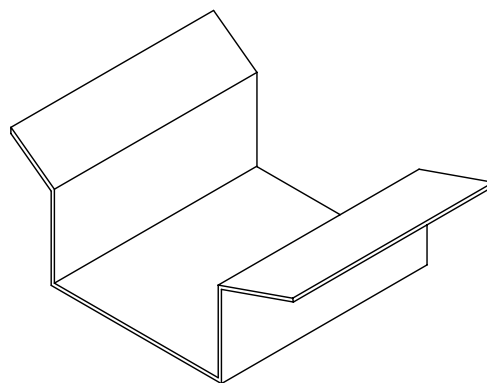
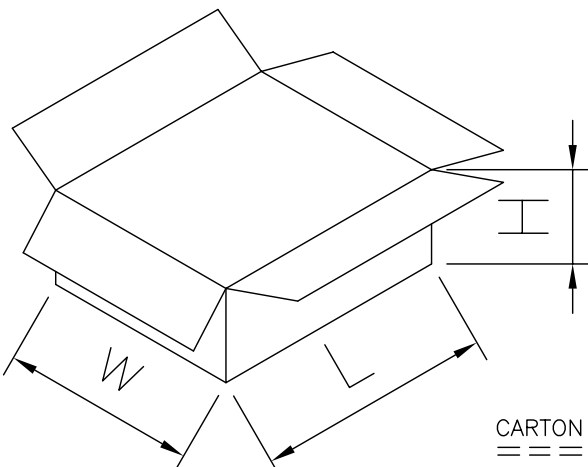
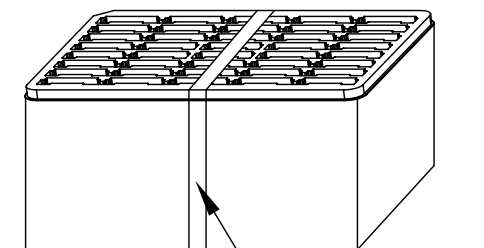
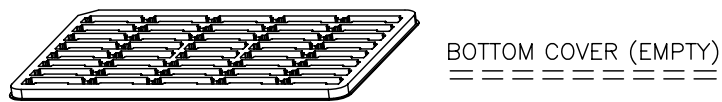
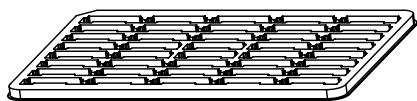
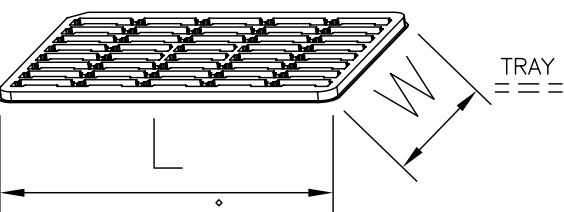
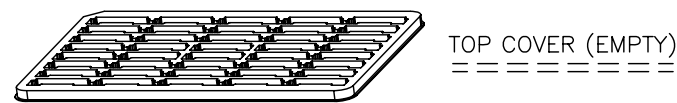

THIS DRAWING IS A CONTROLLED DOCUMENT.		DWN		Tyco Electronics Corporation Taipei, Taiwan	
DIMENSIONS: MM		CHK		NAME	
TOLERANCES UNLESS OTHERWISE SPECIFIED:		APVD		2.0 PITCH MODU REC ASS'Y, 44P RIGHT ANGLE, STANDOFF 2.2MM CENTER HEIGHT, SMT TYPE.	
0 PLC ± -		PRODUCT SPEC		SIZE	
1 PLC ± -		APPLICATION SPEC		CAGE CODE	
2 PLC ± -		WEIGHT		DRAWING NO	
3 PLC ± -		CUSTOMER DRAWING		RESTRICTED TO	
4 PLC ± -		SCALE		SHEET	
ANGLES ± -		SHEET		REV	
MATERIAL		SHEET 2 OF 2		C1	
FINISH		A3 00779		C=1470492	