

keyway

opposite keyway

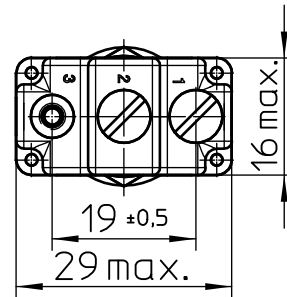
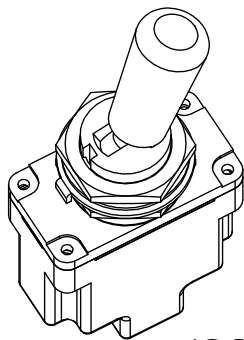
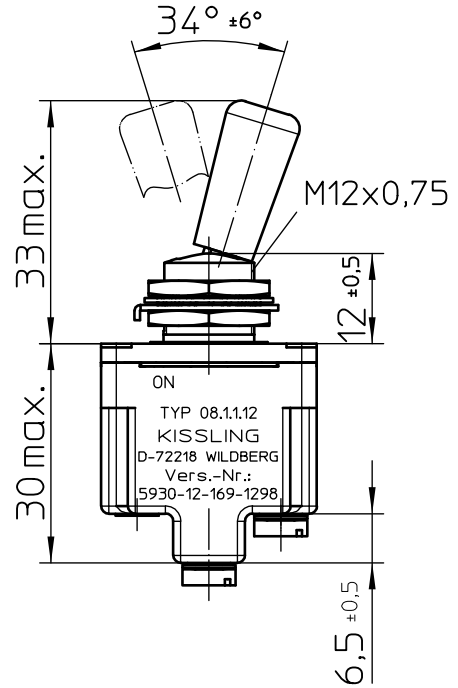
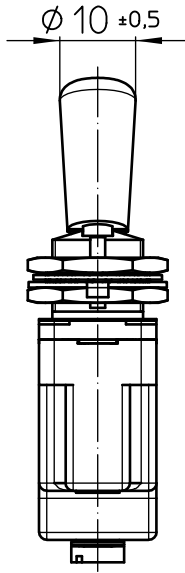

Mounting Detail

with locking ring

without locking ring

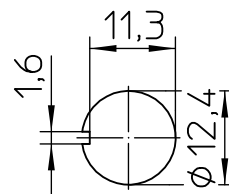
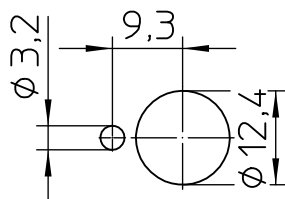

Third Angle Projection

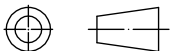

	Date	Name	mm	Scale	 Elektrotechnik - GmbH & Co KG D - 72218 Wildberg	Drawing No:
Drawn	15.10.1997	Kulli		1:1		08-1-1-12
Check	03.11.2005	Braun	General Tolerances DIN ISO 2768 mK		NSN:	5930-12-169-1298

Circuit Diagram

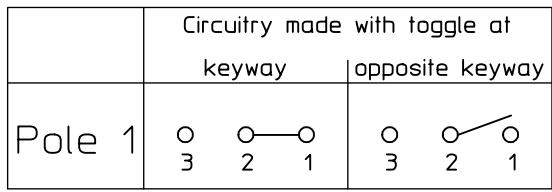

Actuation

momentary keyway side
locking opposite keyway side

Construction

Material, Casing Duroplast GF
 Material, Cover GD-ZnAl4Cu1
 Connections Screws M3,5x6 ISO 1580
 Protection Interior IP 6K7 DIN 40 050 Part 9
 Connections IP 00 DIN 40 050 Part 9

Mechanical Data

Current carrying parts CuZn-Alloy
 Contacts Ag
 Ambient Temperature Range -55°C to +85°C
 Storage Temperature Range -65°C to +85°C
 Life Cycle iaw VG 95 210 Part 21, grade H 100.000 operations

Electrical Data

Voltage 28 V DC ohmic Load 15A
 28 V DC inductive Load at L/R = 5 ms 10A
 28 V DC lamp Load 4A
 115 V AC ohmic Load 15A
 115 V AC inductive Load cos. Φ = 0,75, 7A
 115 V AC lamp Load 2A
 Motor Load utilisation category AC3 (see DIN VDE 0660 Part 107) 5A

Min. Rating 12 V DC, 20 mA

It is recommended to use gold-plated contacts
for lower currents or voltages.

	Date	Name	mm ←	Scale 1:1		Drawing No: 08-1-1-12
Drawn	15.10.1997	Kulli	General Tolerances DIN ISO 2768 mK			NSN.: 5930-12-169-1298
Check	03.02.2003	Braun				