



RAST CONNECTOR SYSTEM

IDC & CRIMP CONNECTOR SYSTEM AND RAST TAB HEADER

This page has been intentionally left blank

TE Connectivity

TE Connectivity (TE) is a \$13 billion world leader in connectivity. The company designs and manufactures products at the heart of electronic connections for the world's leading industries including automotive, energy and industrial, broadband communications, consumer devices, healthcare, and aerospace and defense. TE's long-standing commitment to innovation and engineering excellence helps its customers solve the need for more energy efficiency, always-on communications and ever-increasing productivity.

Leading Connectivity Solutions for over 100 Years

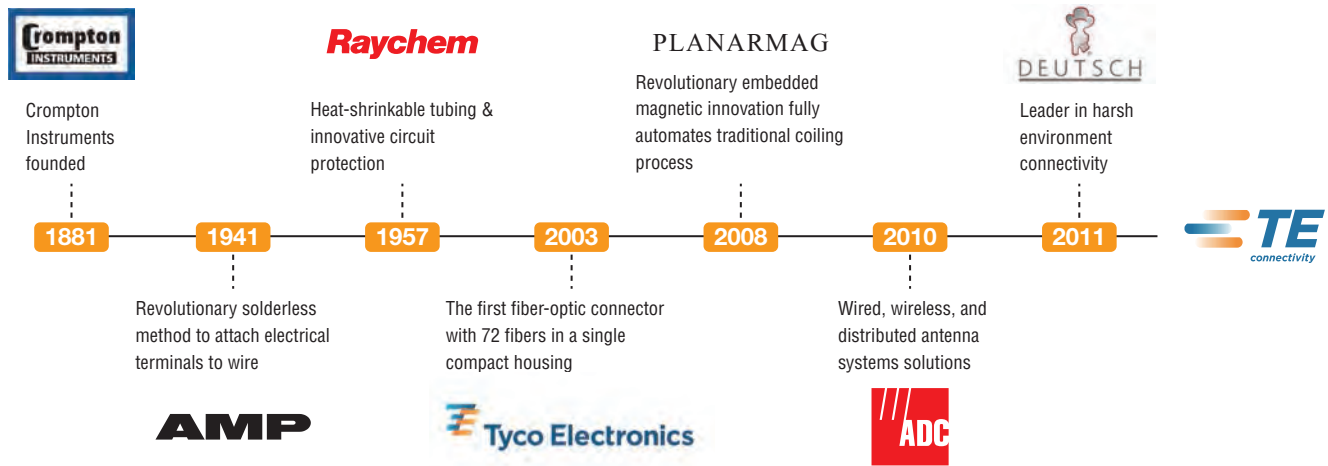

TE Appliances connects excellence



TE has over 60 years' experience in serving the global home appliances market. We focus on developing innovative connectivity solutions for the most capable and complex home appliances on the market. Our solutions are also broadly applied in other industries such as industrial machinery, HVAC, commercial building, automobiles and rail. By offering extensive product lines in the industry, TE Appliances provides customers a one-stop shopping experience that dramatically saves time and effort.

Product Lines



Broad Applications of TE Appliances Solutions



With rich industry experience and advanced technology and manufacturing capabilities, TE Appliances commits itself to offering highly consistent and reliable products. By combining its global expertise with local manufacturing, TE Appliances continuously looks to lower production costs for its customers.

7 Manufacturing Locations Worldwide

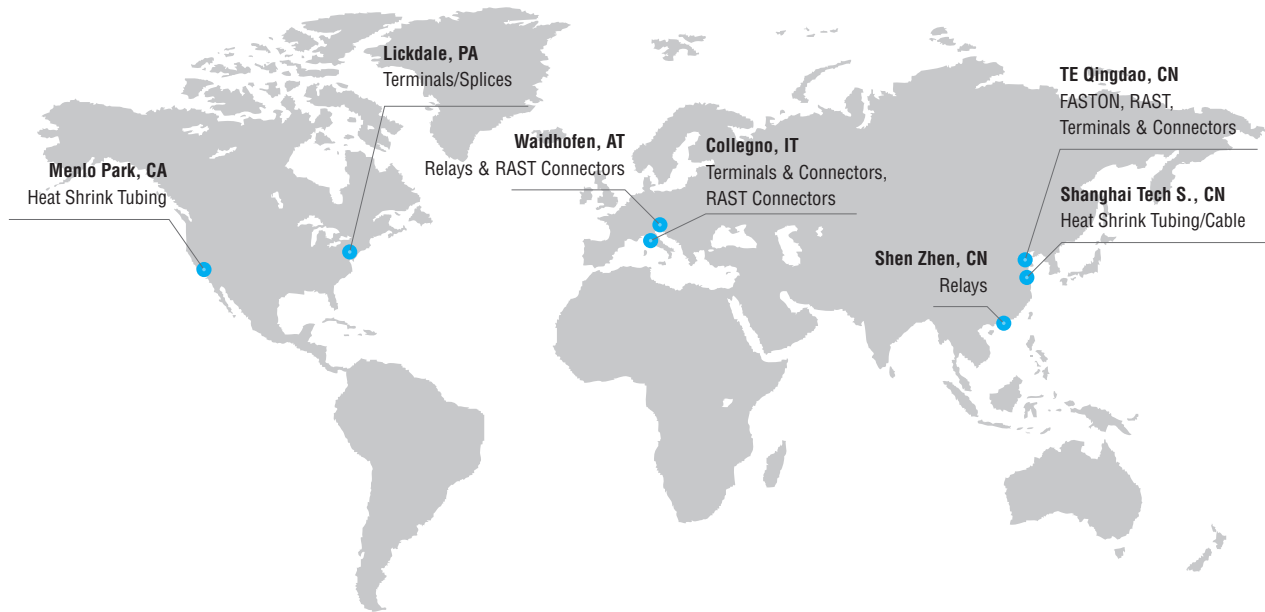

RAST Connector System Introduction

As a technology leader that designs and manufactures products at the heart of electronic connections for the world's leading industries, TE offers one of the most comprehensive RAST product series in the market.

TE RAST 2.5 and 5 centerline connectors are ideal for both automatic and manual production lines. The RAST IDC (Insulation Displacement Contact) connector system, including AMP multifitting connectors, AMP MONO-SHAPE connectors, and AMP DUOPLUG connectors, is specially designed for safe and fast automatic productions. The normal crimping solutions, including product lines from RAST 5 standard timer connectors, Positive Lock RAST 5 connectors to FASTIN-FASTON tab housing, are easily applicable in manual productions. The innovative RAST connector series offers a full range of vertical and right-angle mating headers.

Besides product solutions, TE provides a full series of application tooling, which help dramatically enhance productivity and quality.

Key Products

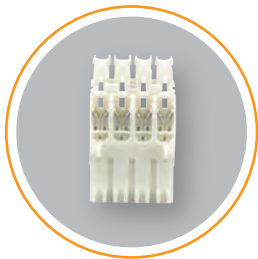

AMP multifitting mark II

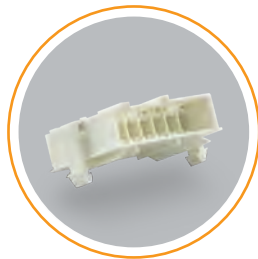

FASTIN-FASTON Tab Header



Positive Lock Connector

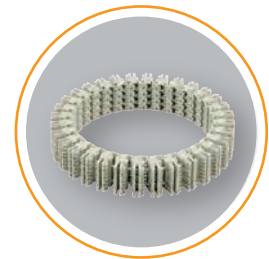

DUOPLUG power connector



Standard Timer Contact

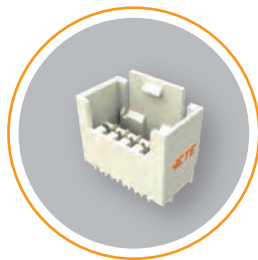

RAST 2.5 Tab Header

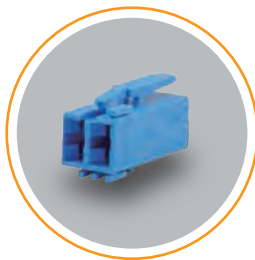

Standard Timer Connector

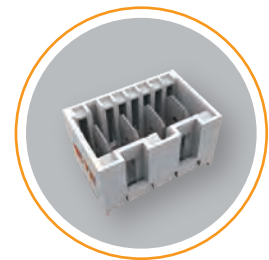

RAST 5 Tab Header

Table of Contents

AMP multifitting mark II

Introduction 1
 Direct and Indirect Mating Connection, 5.0 mm Centerline 2
 Derating Curves 3
 Keying Plan and Cable Exit 4
 Technical Features 5
 AMP multifitting Mark II Tab 6
 AMP multifitting Mark II PCB version 10

AMP MONO-SHAPE

Introduction 12
 AMP MONO-SHAPE Connector Versions 13
 AMP MONO-SHAPE Tab Connector 14
 AMP MONO-SHAPE Tab Connector-Rear Lock Version 22
 AMP MONO-SHAPE PCB (Printed Circuit Board) Connector 24
 AMP MONO-SHAPE Single Way Connector 28
 Keying Plan from Mating Direction 29
 AMP MONO-SHAPE Satellite Connector 31
 Keying Plan from Mating Direction 32

AMP Standard Timer

Introduction 33
 Interior and Exterior Locking 34
 Keying Plan and Housings 35
 Housings—Exterior Lock 36
 Housings—Interior Lock 46
 Standard Timer Connector and Contacts 51

FASTIN-FASTON RAST 5

Introduction 52
 FASTIN-FASTON Tab Housings RAST 5 53
 Pannel Mount Housing 54
 Motor Mount Housing 62

Positive Lock RAST 5 Connector System

Positive Lock RAST 5 Connector System 63

RAST 5 Tab Header

Introduction 65
 DIN Style, Vertical 66
 DIN Style, Vertical, Opposite 69
 Positive Lock connector Style, Vertical 72
 RAST 5 Positive Lock Tab Header (GWT) 76
 RAST 5 Positive Lock Tab Header, Opposite (GWT) 78
 Positive Lock connector Style 80

AMP DUOPLUG 2.5 Connector System

Introduction 86
 Technical Features 87
 Indirect and Direct Connection, 2.5 mm Centerline 88
 AMP DUOPLUG 2.5 Female Connectors Fully Loaded 89
 AMP DUOPLUG 2.5 Female Connectors Selectively Loaded 93

Table of Contents

AMP DUOPLUG 2.5 PC Board Frame

Introduction 96
 AMP DUOPLUG 2.5 PC Board Frame 97
 AMP DUOPLUG 2.5 Male Connector-Panel mount..... 99

AMP DUOPLUG 2.5 Mark II Connector

Introduction 100
 Technical Features 101
 Indirect and Direct Connection, 2.5 mm Centerline 102
 Technical Data..... 103
 Performance Diagrams 104
 Keying Plan and Female Connector Geometry 106
 AMP DUOPLUG 2.5 Mark II Female Connectors Selectively Loaded..... 107

AMP DUOPLUG Power Connector

Introduction 110
 Technical Features 111
 Indirect and Direct Connection, 5.0 mm Centerline 112
 Technical Data..... 113
 Performance Diagrams 114
 Keying Plan..... 115
 AMP DUOPLUG Power Female Connectors Fully Loaded..... 116
 AMP DUOPLUG Power Female Connectors Selectively Loaded 118
 AMP DUOPLUG Power Male connector 119

RAST 2.5 Tab Header

Introduction 120
 Fully Loaded, External Locking..... 121
 Fully Loaded, Internal Locking 125
 Selectively Loaded, External Locking 129

RAST Application Tooling

Applicators 132
 IDC Bench-Top for AMP DUOPLUG 2.5 connector 133
 Workstations for FHM IDC Flexible Harness Maker 134
 SIM Compact; semi automatic machine 135
 IDC Harness Makers - FHM 136
 IDC Harness Makers - IHM Mark III 137

Introduction

Product Features

- Direct mating connectors for PC Boards, 2–8 Positions, up to 6A current carrying capacity
- Indirect Mating Connectors, 1-4 Positions up to 16A and 1-9 Positions up to 10A
- Variable keying

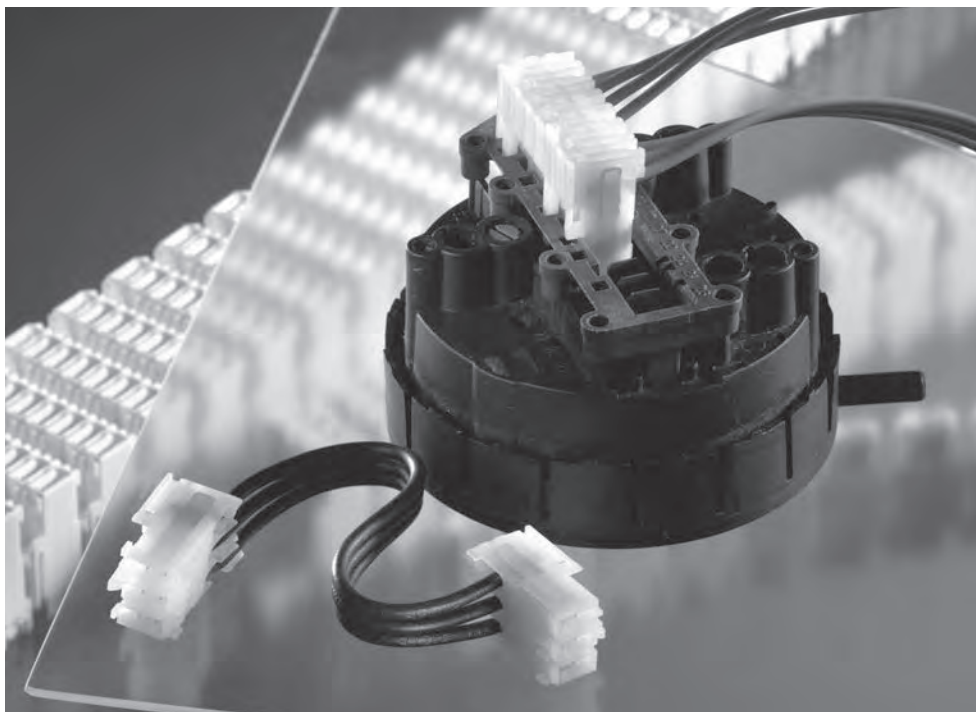

TE's designed AMP multifitting mark II connector system was developed according to the latest connector design standards.

The requirements of advanced in-line mating technology for the components and contacts of pc boards are incorporated in the direct and indirect versions of these connector systems.

This system is suitable for a wide wire size range. Current carrying capacity is 16 A maximum.

The connectors are available in 1- to 9-positions (indirect) resp. 2- to 8- positions (direct) with an exterior locking device.

Interior locking options are available on request.

Supplied in chain and provided with all keying and polarisation ribs, the connectors can be operated economically with modern application tooling equipment.

Direct and Indirect Mating Connection, 5.0 mm Centerline

**Direct Mating Connection,
5.0 mm Centerline**

- 1 Wire exit 90°
- 2 Wire exit 180°
- 3 Cover
- 4 Exterior locking latch
- 5 Keying
- 6 Polarisation

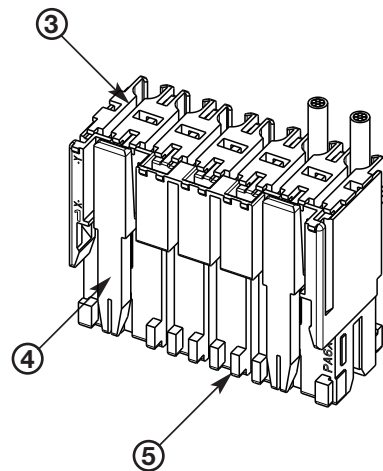
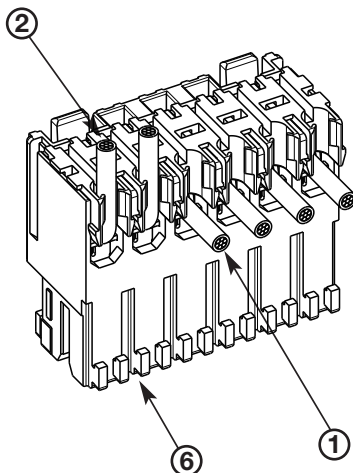

**Indirect Mating Connection,
5.0 mm Centerline**

- 1 Wire exit 90°
- 2 Wire exit 180°
- 3 Cover
- 4 Exterior locking latch
- 5 Keying
- 6 Polarisation

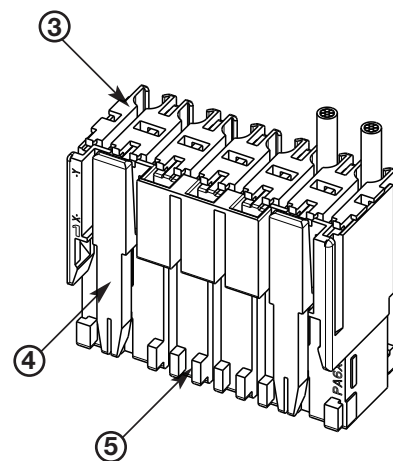
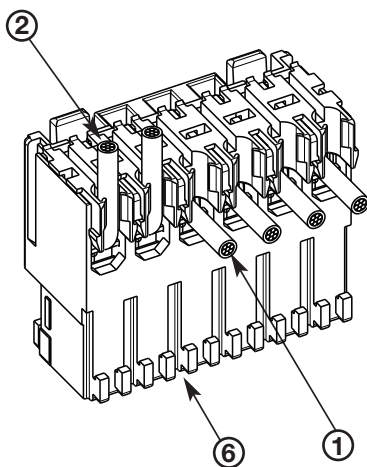

**Indirect Mating Connection
with Interior Locking,
5.0 mm Centerline**

- 1 Wire exit 90°
- 2 Wire exit 180°
- 3 Cover
- 4 Interior locking latch
- 5 Keying
- 6 Polarisation

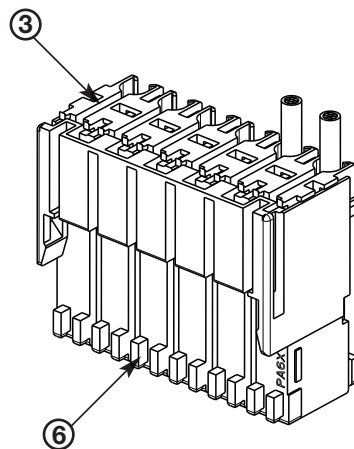
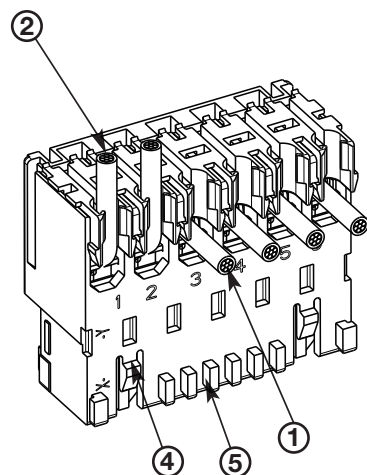

Derating Curves

Direct Mating Connector System

Connector:
8 positions

Material:
Brass, tin plated

Wire:
0.5 mm²

PC Board:
FR4, 2 x 0.35 µm Copper,
tin plated

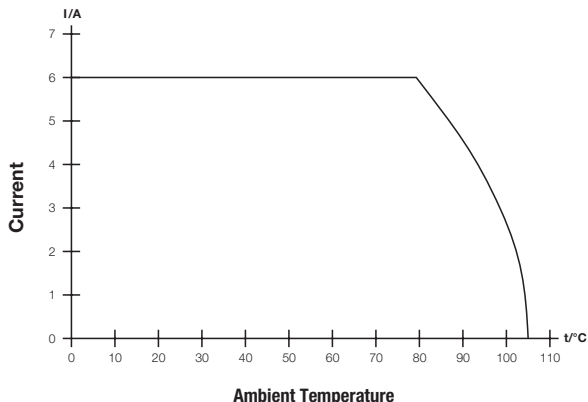

Indirect Mating Connector System

Material:
Brass, tin plated

Wire:
0.5 mm² (Curve 1 and 2)
1.0 mm² (Curve 3)

Mating Part:
6.3 x 0.8 mm Tab,
Brass, tin plated

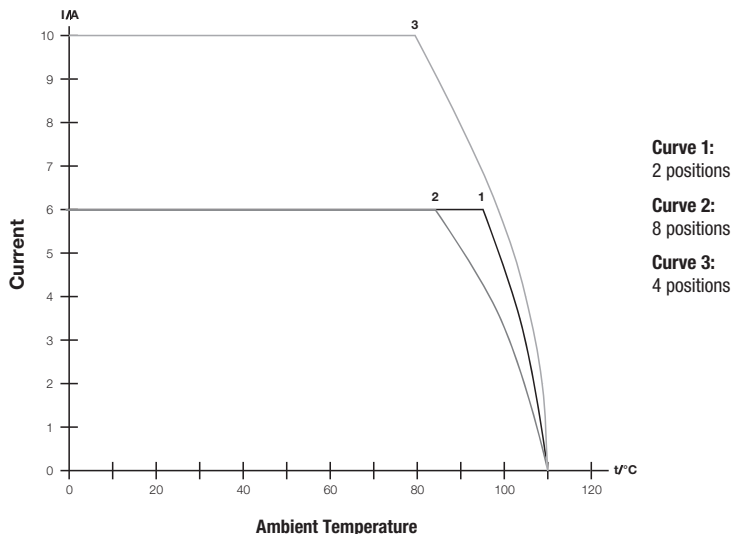

Indirect Mating Connector System

Material:
Copper alloy, silver plated

Wire:
1.5 mm², tin plated

Mating Part:
6.3 x 0.8 mm Tab,
Brass, tin plated

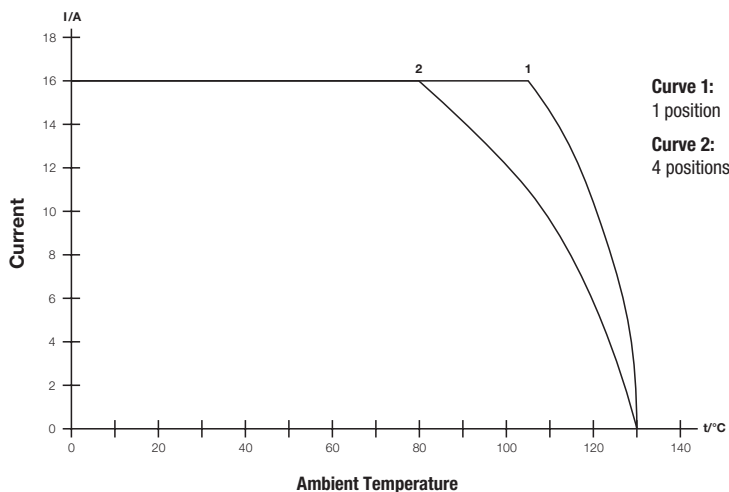

Keying Plan and Cable Exit

**Keying Plan
from Mating Direction,
Fully-Keyed Version**

- 1 Locking latch
- 2 Keying rib
- 3 Polarisation rib
- 4 Cavity number

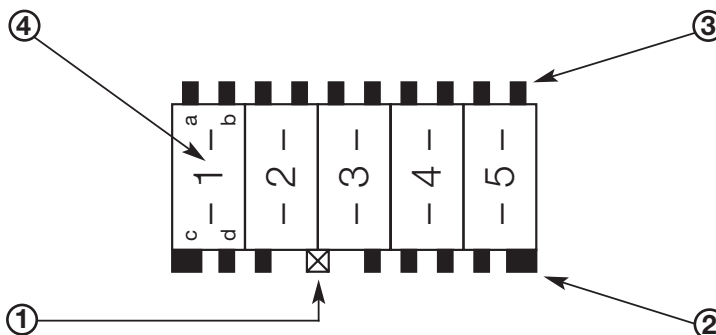

Keyed Version:
05-C according to RAST 5

This final keying version will be produced on the application tooling equipment.

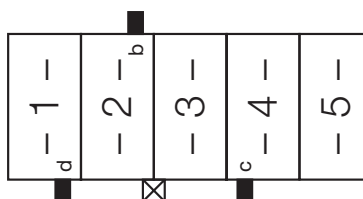

**Cable Exit with Interior
and Exterior Locking**

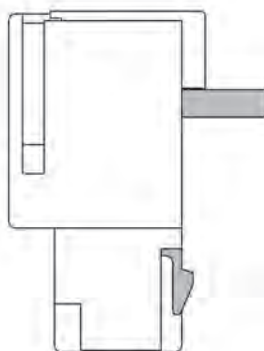

Cable Exit with Interior Locking

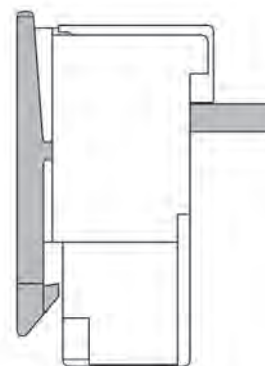

Cable Exit with Exterior Locking

**Direct Mating of a PCB
with PC Board Frames**

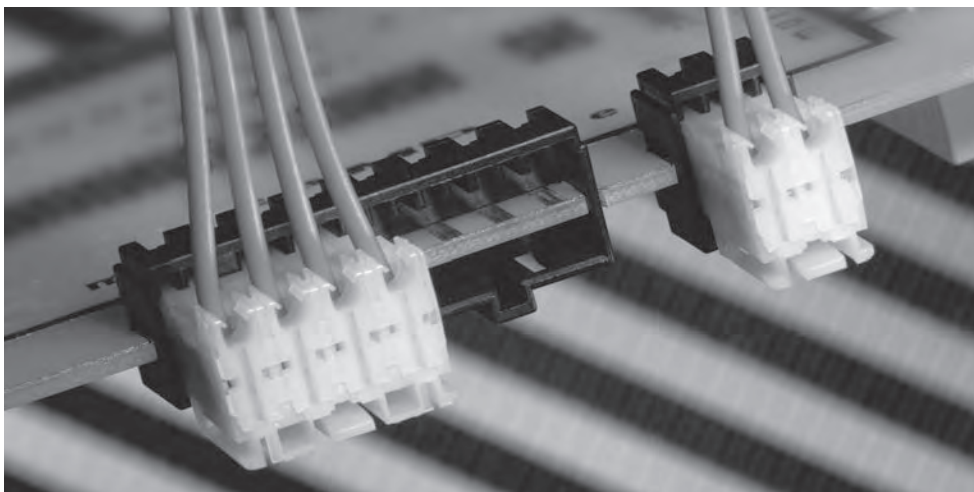

Technical Features

Technical Data

Centerline:
5.0 mm

Housing Material:
Polyamide, PA 6.6 and PA 6

Standard Colour:
Natural

Current Voltage:
250 V ≈

Air and Creepage Distance:
>3.2 mm

Flammability Rating:
UL 94 V-2

Approvals:
VDE, UL

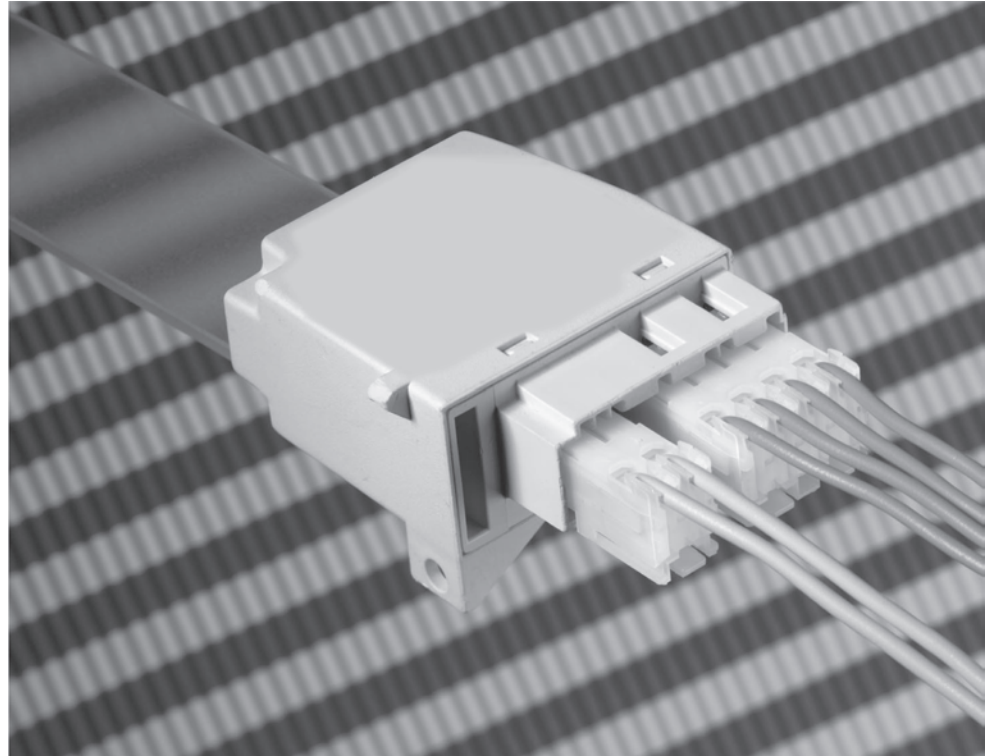

1

AMP multifitting Mark II

Direct Mating Connectors

No. of Positions:

2- to 8-positions

Contact Material:

Brass

Contact Finish:

Tin plated

Wire Size Range:

0.35–1.0 mm²

Temperature Range:

–40 °C up to +105 °C

Current Rating:

6 A max.

Insulation Diameter:

2.8 mm max.

Insulation Resistance:

>10 MΩ

Mating Force:

≤7 N per contact*

Unmating Force:

≥1.5 N*

Product Specification:

108-18653

Application Specification:

114-18289

*) measured with polished steel plate 1.5 mm thickness

Indirect Mating Connectors

No. of Positions:

1- to 9-positions

Contact Material:

Brass / Copper alloy

Contact Finish:

Tin plated / silver plated

Wire Size Range:

0.35–1.0 mm² / 1.0–1.5 mm²

Temperature Range:

–40 °C up to +130 °C

Current Rating:

10 A, up to 4 contacts 16 A

Insulation Diameter:

3.0 mm max.

Insulation Resistance:

>10 MΩ

Mating Force:

≤6.5 N per contact**

Unmating Force:

≥1.5 N*

Product Specification:

108-18652

Application Specification:

114-18288, 114-18382

**) measured with polished steel tab 6.3 x 0.8 mm

AMP multifitting Mark II Tab

Technical Data

Wire Size Range:
0.35–1.0 mm²

Current Carrying Capacity (max.):
10 A

Pos.	RAST 5 Version	Part Numbers with Exterior Locking		Part Numbers with Interior Locking	
		PA 6.6	PA 6 *	PA 6.6	PA 6 *
1		1241170-1	1534072-1	1241170-1	1534072-1
2		1241170-2	1534072-2	1394355-2	1534077-2
3		1241170-3	1534072-3	1394355-3	1534077-3
		1-1241170-3	1-1534072-3	1-1394355-3	1-1534077-3
4		1241170-4	1534072-4	1394355-4	1534077-4
		-	1-1534072-4	1-1394355-4	-
5		1241170-5	1534072-5	1394355-5	1534077-5

*) According to IEC 60695-2-11; GWT (Glow Wire Test) 750 °C without flame, see VDE M-Test Report.
The final keying version will be produced on the application tooling equipment.

AMP multifitting Mark II Tab

Technical Data

Wire Size Range:
0.35–1.0 mm²

Current Carrying Capacity (max.):
10 A

Pos.	RAST 5 Version	Part Numbers with Exterior Locking		Part Numbers with Interior Locking	
		PA 6.6	PA 6 *	PA 6.6	PA 6 *
5		1-1241170-5	1-1534072-5	-	1-1534077-5
		5-1241170-5	5-1534072-5	-	-
6		1241170-6	1534072-6	-	-
		1-1241170-6	1-1534072-6	-	-
		2-1241170-6	-	-	-
7		1241170-7	1534072-7	1394355-7	1534077-7
		1-1241170-7	1-1534072-7	-	-

*) According to IEC 60695-2-11; GWT (Glow Wire Test) 750 °C without flame, see VDE M-Test Report.
The final keying version will be produced on the application tooling equipment.

AMP multifitting Mark II Tab

Technical Data

Wire Size Range:
0.35–1.0 mm²

Current Carrying Capacity (max.):
10 A

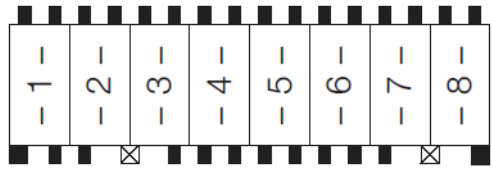
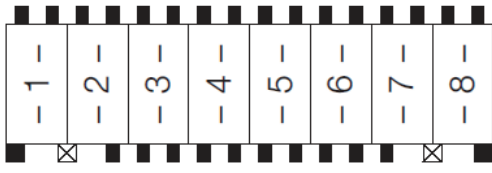
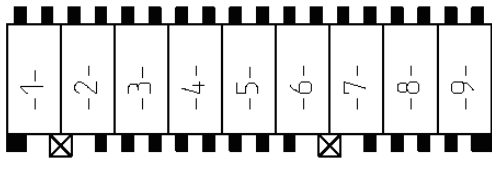
Pos.	RAST 5 Version	Part Numbers with Exterior Locking		Part Numbers with Interior Locking	
		PA 6.6	PA 6 *	PA 6.6	PA 6 *
8		1241170-8	-	-	-
		1-1241170-8	1-1534072-8	-	-
9		1241170-9	-	-	-

*) According to IEC 60695-2-11; GWT (Glow Wire Test) 750 °C without flame, see VDE M-Test Report.
The final keying version will be produced on the application tooling equipment.

AMP multifitting Mark II Tab

Technical Data

Wire Size Range:
1.0–1.5 mm²

Current Carrying Capacity (max.):
16 A

Pos.	RAST 5 Version	Part Numbers with Exterior Locking		Part Numbers with Interior Locking	
		PA 6.6	PA 6 *	PA 6.6	PA 6 *
1		1241171-1	1534073-1	-	-
2		1241171-2	1534073-2	-	-
3		1241171-3	1534073-3	-	-
		-	1-1534073-3	-	-
4		1241171-4	1534073-4	-	-
		1-1241171-4	1-1534073-4	-	-
		-	2-1534073-4	-	-

*) According to IEC 60695-2-11; GWT (Glow Wire Test) 750 °C without flame, see VDE M-Test Report.
The final keying version will be produced on the application tooling equipment.

AMP multifitting Mark II PCB version

Technical Data

Wire Size Range:
0.35 – 1.0 mm²

Current Carrying Capacity (max.):
6 A

Pos.	RAST 5 Version	Part Numbers	
		PA 6.6	PA 6 *
2		1241172-2	1534075-2
3		1241172-3	1534075-3
		-	1-1534075-3
4		1-1241172-4	1534075-4
		-	1-1534075-4
5		1241172-5	1534075-5
		1-1241172-5	5-1534075-5

*) According to IEC 60695-2-11; GWT (Glow Wire Test) 750 °C without flame, see VDE M-Test Report.
The final keying version will be produced on the application tooling equipment.

AMP multifitting Mark II PCB version

Technical Data

Wire Size Range:
0.35 – 1.0 mm²

Current Carrying Capacity (max.):
6 A

1
AMP multifitting Mark II

Pos.	RAST 5 Version	Part Numbers	
		PA 6.6	PA 6 *
6		-	1534075-6
		-	1-1534075-6
		-	2-1534075-6
7		-	1-1534075-7
8		-	1534075-8

*) According to IEC 60695-2-11; GWT (Glow Wire Test) 750 °C without flame, see VDE M-Test Report.
The final keying version will be produced on the application tooling equipment.

Introduction

AMP MONO-SHAPE Connectors in In-Line Mating Technology

AMP MONO-SHAPE connectors represent a valid solution to the ever-increasing requirements for production and application flexibility. They are high productivity, great flexibility, quality, minimum applied cost.

AMP MONO-SHAPE product line includes a full range of 5.0 mm pitch modular connectors contents with similar outer shape, several variation in the mating area such as PC Board and 6.3 x 0.8 mm tabs (RAST 5), plus a version for harness shunts.

AMP MONO-SHAPE connection system adopts the IDC termination technology, which improves application results and quality level.

The AMP MONO-SHAPE product range, combined with the performances and properties offered by the termination system, allow to manufacture extremely complicated harness structures while still maintaining high production levels.

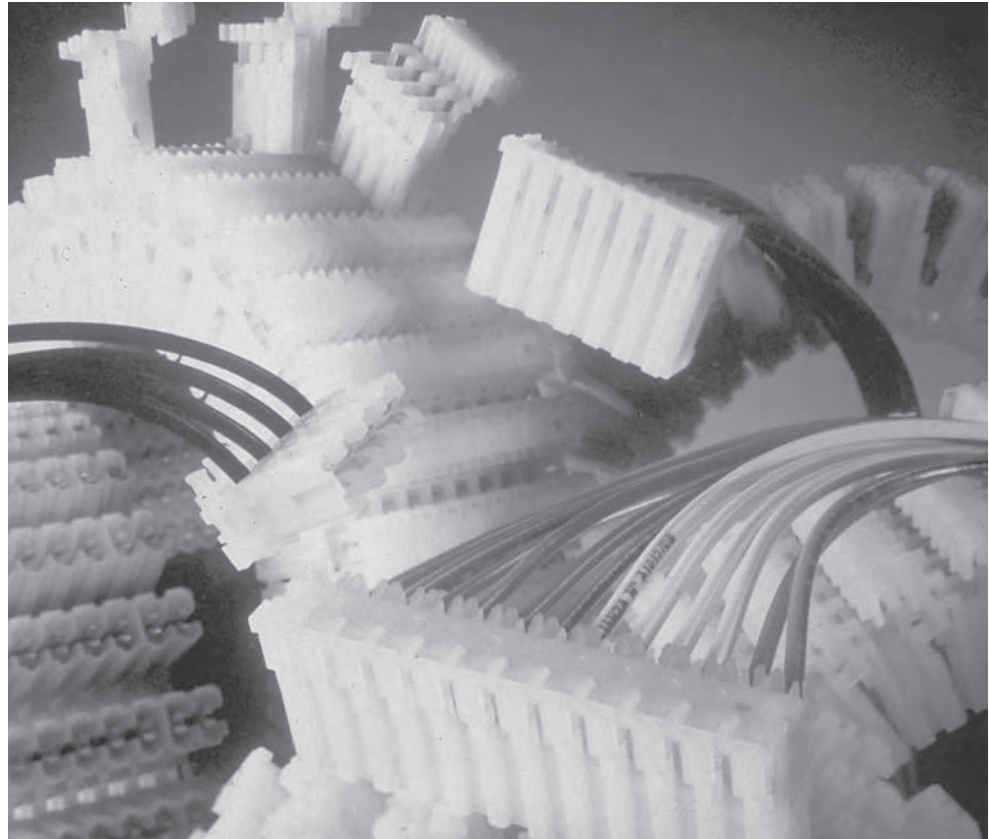

Technical Features

- IDC connector system is designed to maximise the full integration with the application tooling assuring total flexibility in harness design.
 - High current system, up to 16 Ampere, designed to satisfy several appliance requirements.
 - IDC contact is designed to accept standard discrete wires ranging from 0.5 up to 1.5 mm², according to the connector configuration.
 - The connector incorporates modern in-line mating technology on a 5.0 mm centerline with no loss of spacing and a variety of keying possibilities.
 - Wiring faults eliminated through high automation.
 - Specific Silicone-IDC wires are applicable
- Approvals:
- UL E 28476 Vol. 9 Sec. 7;
97 ME 17936; AP-27HB

AMP MONO-SHAPE Connector Versions

**Same Shape-
Different Applications**

With the same outside shape, four connector versions are able to utilize the same application tooling.

TAB Connectors

2–12 position 5.0 mm pitch connectors with insulation displacement contacts mateable with components according to RAST 5 and with tinned copper alloy tab 6.3 x 0.8 mm according to DIN 46244.

Wire Size Range:
0.5–1.5 mm²

Current Rating:
16 Ampere max. acc. to wire size
-For LIF version up to
10 Ampere max

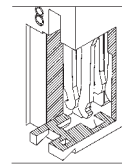
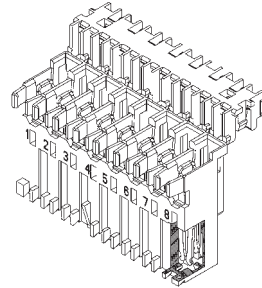

LIF version 2 point contact instead of 4 as per standard version

Single Way Connectors

Single way connectors with insulation displacement contacts for use on tinned copper alloy tab 6.3 x 0.8 mm according to DIN 46244.

Wire Size Range:
0.5–1.5 mm²

Current Rating:
16 Ampere max. acc. to wire size

Supply Status:
In order to increase productivity these items are supplied in sticks.

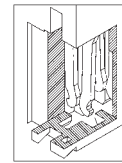
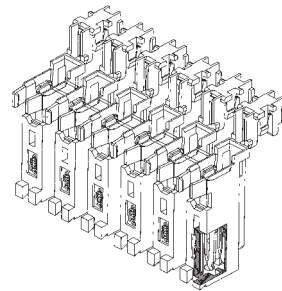

PCB Connectors

2–12 position 5.0 mm pitch connectors with insulation displacement contacts according to printed circuit boards with thickness 1.5±0.2 mm and 5.0 mm pitch.

Wire Size Range:
0.5–0.75 mm²

Current Rating:
6 Ampere max. acc. to wire size

PC Board:
Single or both sides printed 5 µm tin over 35 µm copper

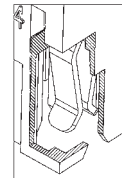
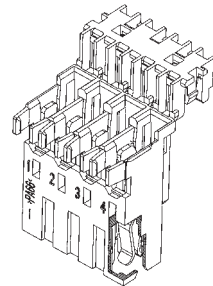

Satellite Connectors

3 position connectors, pitch 5.0 mm, with short circuited insulation displacement contacts for harness shunts.

Wire Size Range:
0.5–1.5 mm²

Current Rating:
16 Ampere max. acc. to wire size

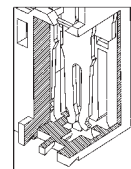
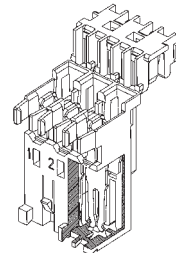

AMP MONO-SHAPE Tab Connector

**AMP MONO-SHAPE
Tab Connector**

- 1 Cover closed after wire insertion. wire direction 90°. 180° when locked in cover recess
- 2 Cavity numbers
- 3 Polarisation similar to the keying (located on the back Side)
- 4 Keying
- 5 Interior locking latch
- 6 Colour marking

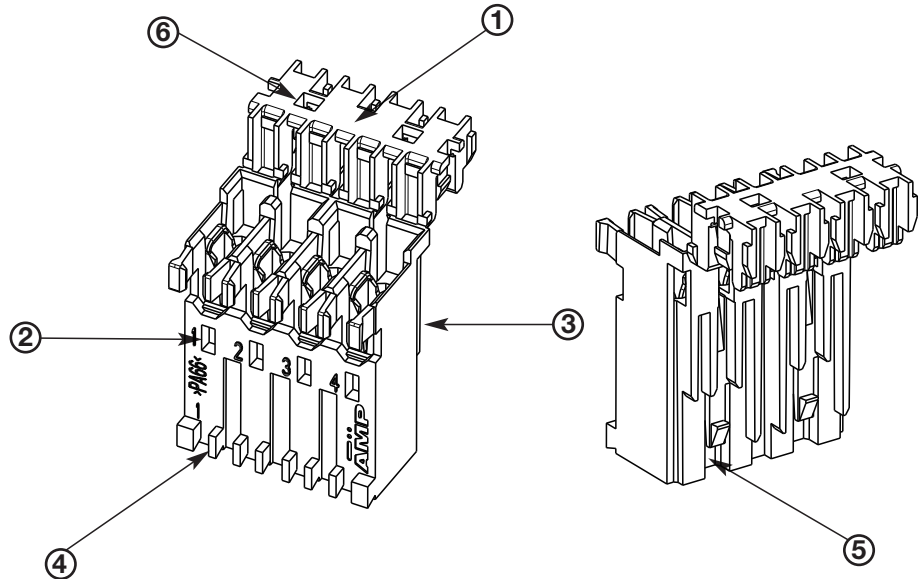

Technical Features

Centerline:

5.0 mm, according to RAST 5 specifications

Configurations:

2- to 12-positions

Housing Material:

Plastic PA 6.6

Housing Colour:

Natural colour for standard version
Grey colour for LIF version

Contact Material:

Copper alloy, post-tinned 2.0 µm min.

Polarisation, Keying, Locking Latches:

according to RAST 5 specifications
(see customer drawings)

Track Resistance:

as per IEC 112 (250 V)

Glow Wire Test:

IEC 60695-2-11; GWT (Glow Wire Test) 750 °C without flame

Air and Creepage Distance:

according to EN 60998-1 (IEC 998-1) for 380 V, ≥4.0 mm

Voltage Resistance:

according to EN 60998-1 (IEC 998-1) 1750 V for 4 minutes

Insulation Resistance:

according to EN 60998-1 (IEC 998-1) >5 MΩ

Wire Size Range:

from 0.5 to 1.5 mm²

Current Rating:

Standard Version

16 A max. according to wire size
0.5 mm² ≤ 3 A, 0.75 mm² ≤ 6 A,
1.0 mm² ≤ 10 A, 1.5 mm² ≤ 16 A

LIF Version

10 A max. according to wire size
0.5 mm² ≤ 3 A, 0.75 mm² ≤ 6 A,
1.0 mm² ≤ 10 A, 1.5 mm² ≤ 10 A

Rated Voltage:

380 Volts max.

Wire Type:

H05V-K (70 °C max.)

or FR 3/2 (105 °C max.)

for 0.5–1.0 mm² wires with copper or tinned stranded wires

H07V-K (70 °C max.)

or FR 3/2 (105 °C max.)

for wires from 1.5 mm² with copper or tinned stranded wires

Insulation Type:

PVC suitable for temperatures up to 70 °C / 105 °C

Insulation Diameter Range:

2.0–3.5 mm

Temperature Range:

–25 °C up to +105 °C

Wire Extraction Force/Way:

50 N min. on wire size 0.5 mm²

Application Specification:

114-20016

Product Specification:

Standard version: 108-20065

LIF version: 108-20215

Homologations:

acc.to UL File No. E28476 (to 14 A)

AMP MONO-SHAPE Tab Connector

**Keying Plan
from Mating Direction,**

- 1 Locking latch
- 2 Slanted keying rib
- 3 Keying rib
- 4 Polarisation rib
- 5 Cavity number

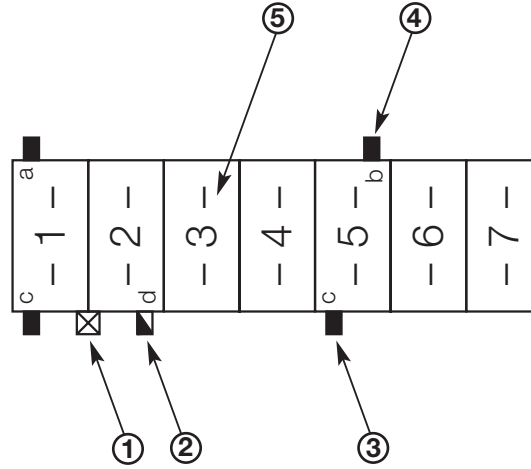

**AMP MONO-SHAPE
Tab Connector
(GWT 750°C No Flame + UL 94 V2)**



**2 Position RAST 5 Variations
(Variable Keying)***

Suitable for RAST 5 Version Colour Marking	RAST 5 Version	Part Numbers		
		On Tray	Loose Piece	On Reel
02-C Black		1-282002-1 1-284338-1	2-282002-1 -	- -
02-B 02-E 02-F Grey		1-282002-2 1-284338-2	2-282002-2 -	- -
02-L 02-P Red		1-282002-3 1-284338-3	- -	- -
02-A 02-O Blue		1-282002-4 1-284338-4	- -	- -
02-Q Black		1-282002-5 -	2-282002-5 -	- -
- Black		1-282002-6 -	2-282002-6 -	- -

* Final keying version is produced on the application tooling machines.
Bold Part Numbers are LIF Version

AMP MONO-SHAPE Tab Connector

**2 Position RAST 5 Variations
(Variable Keying)***

Suitable for RAST 5 Version Colour Marking	RAST 5 Version	Part Numbers		
		On Tray	Loose Piece	On Reel
- Natural		1-282002-7 1-284338-7	- -	- -
02-B 02-E 02-F Green		5-282002-2 -	- -	- -
02-B 02-E 02-F Yellow		5-282002-2 -	- -	- -

* Final keying version is produced on the application tooling machines.
Bold Part Numbers are LIF Version

AMP MONO-SHAPE Tab Connector

**3 Position RAST 5 Variations
(Variable Keying)***

Suitable for RAST 5 Version Colour Marking	RAST 5 Version	Part Numbers		
		On Tray	Loose Piece	On Reel
03-A 03-I Orange		1-282003-1 1-284339-1	- -	- -
03-B 03-K Blue		1-282003-2 1-284339-2	- -	- -
03-F Green		1-282003-3 1-284339-3	- -	- -
03-B 03-K Red		1-282003-4 1-284339-4	- -	- -
03-B 03-K Grey		1-282003-5 1-284339-5	2-282003-5 -	- -
- Violet		1-282003-6 -	2-282003-6 -	- -
03-B Black		1-282003-7 -	- -	- -
- Black		1-284396-1 -	- -	- -

* Final keying version is produced on the application tooling machines.
Bold Part Numbers are LIF Version

2

AMP MONO-SHAPE

AMP MONO-SHAPE Tab Connector

**4 Position RAST 5 Variations
(Variable Keying)***

Suitable for RAST 5 Version Colour Marking	RAST 5 Version	Part Numbers		
		On Tray	Loose Piece	On Reel
04-A Grey		1-282004-1 -	- -	- -
04-D Black		1-282004-2 -	2-282004-2 -	- -
04-A Red		1-282004-3 -	- -	3-282004-3 -
- Blue		1-282004-4 -	- -	- -

* Final keying version is produced on the application tooling machines.
Bold Part Numbers are LIF Version

**5 Position RAST 5 Variations
(Variable Keying)***

Suitable for RAST 5 Version Colour Marking	RAST 5 Version	Part Numbers		
		On Tray	Loose Piece	On Reel
- Red		1-282005-1 -	- -	- -
- Red		1-284545-1 -	- -	- -
- Natural		1-284545-2 -	- -	- -
- Black		1-293003-5 0-293141-2	- -	- -

* Final keying version is produced on the application tooling machines.
Bold Part Numbers are LIF Version

AMP MONO-SHAPE Tab Connector

**6 Position RAST 5 Variations
(Variable Keying)***

Suitable for RAST 5 Version Colour Marking	RAST 5 Version	Part Numbers		
		On Tray	Loose Piece	On Reel
- Violet		1-282006-1 -	- -	- -
- Violet		1-282006-2 -	- -	- -
- Natural		1-282006-3 -	- -	- -
- Black		2-282006-4 0-293142-1	- -	- -
- Red		1-284745-1 -	- -	- -
- Red		1-284745-2 -	- -	- -

* Final keying version is produced on the application tooling machines.
Bold Part Numbers are LIF Version

2

AMP MONO-SHAPE

AMP MONO-SHAPE Tab Connector

**7 Position RAST 5 Variations
(Variable Keying)***

Suitable for RAST 5 Version Colour Marking	RAST 5 Version	Part Numbers		
		On Tray	Loose Piece	On Reel
Natural		1-282007-1 0-293143-1	- -	- -
Violet		1-284397-1 -	- -	- -
Black		1-293003-5 0-293141-2	- -	- -
Red		1-293004-7 -	- -	- -

* Final keying version is produced on the application tooling machines.

Bold Part Numbers are LIF Version

AMP MONO-SHAPE Tab Connector

**8 Position RAST 5 Variations
(Variable Keying)***

Suitable for RAST 5 Version Colour Marking	RAST 5 Version	Part Numbers		
		On Tray	Loose Piece	On Reel
Natural		0-284085-1 1-284685-1	- 2-284685-1	- -
Natural		0-284085-2 -	- -	- -
Natural		1-282010-1 1-284686-1	- -	2-282010-1 -



* Final keying version is produced on the application tooling machines.
Bold Part Numbers are LIF Version

2

AMP MONO-SHAPE

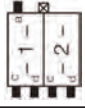

AMP MONO-SHAPE Tab Connector-Rear Lock Version

**2 Position RAST 5 Variations
(Variable Keying)***

Suitable for RAST 5 Version Colour Marking	RAST 5 Version	Part Numbers		
		On Tray	Loose Piece	On Reel
Natural		0-293491-2 -	- -	- -
Natural		1-293491-2 -	- -	- -
Natural		2-293491-2 -	- -	- -

* Final keying version is produced on the application tooling machines.
Bold Part Numbers are LIF Version

**3 Position RAST 5 Variations
(Variable Keying)***

Suitable for RAST 5 Version Colour Marking	RAST 5 Version	Part Numbers		
		On Tray	Loose Piece	On Reel
Natural		0-293491-3 -	- -	- -
Natural		1-293491-3 -	- -	- -

* Final keying version is produced on the application tooling machines.
Bold Part Numbers are LIF Version

AMP MONO-SHAPE Tab Connector-Rear Lock Version

**4 Position RAST 5 Variations
(Variable Keying)***

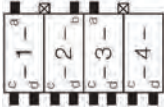
Suitable for RAST 5 Version Colour Marking	RAST 5 Version	Part Numbers		
		On Tray	Loose Piece	On Reel
Natural		0-293491-4 -	- -	- -

* Final keying version is produced on the application tooling machines.
Bold Part Numbers are LIF Version

**8 Position RAST 5 Variations
(Variable Keying)***

Suitable for RAST 5 Version Colour Marking	RAST 5 Version	Part Numbers		
		On Tray	Loose Piece	On Reel
Natural		0-293491-8 -	- -	- -

* Final keying version is produced on the application tooling machines.
Bold Part Numbers are LIF Version

2

AMP MONO-SHAPE

AMP MONO-SHAPE PCB (Printed Circuit Board) Connector

PCB Connector

- 1 Cover closed after wire insertion. Wire direction 90°. 180° when locked in cover recess
- 2 Cavity numbers
- 3 Keying slot in PC board
- 4 Locking hole in PC board
- 5 Colour marking

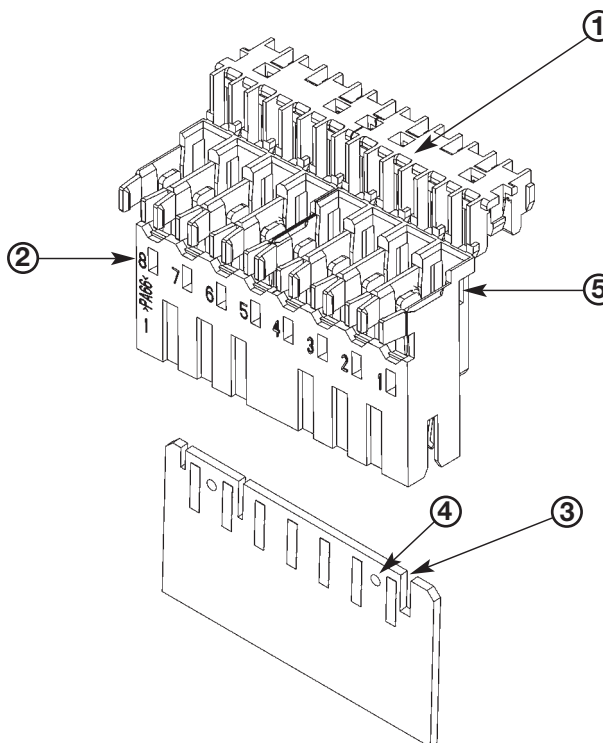

Technical Features

Centerline:
5.0 mm

Configurations:
2-12 positions

Housing Material:
Plastic PA 6.6

Housing Colour:
Natural colour

Contact Material:
Copper alloy, post-tinned 2.0 µm min.

Polarisation, Keying, Locking Latches:
according to RAST 5 specifications (see customer drawings)

Track Resistance:
as per IEC 112 (250 V)

Glow Wire Test:
as per IEC 60695-2-11; GWT (Glow Wire Test) 750 °C without flame

Air and Creepage Distance:
according to EN 60998-1 (IEC 998-1) for 240 V, ≥8.0 mm

Voltage Resistance:
according to EN 60998-1 (IEC 998-1) 1750 V for 4 minutes

Insulation Resistance:
according to EN 60998-1 (IEC 998-1) >5 MΩ

Wire Size Range:
from 0.5 to 0.75 mm²

Current Rating:
6 A max. according to wire size
0.5 mm² ≤ 3 A, 0.75 mm² ≤ 6 A,

Rated Voltage:
220 Volts max.

Wire Type:
H05V-K (70 °C max.)
or FR 3/2 (105 °C max.)
for 0.5–1.0 mm² wires with copper or tinned stranded wires

H07V-K (70 °C max.)
or FR 3/2 (105 °C max.)
for wires from 1.5 mm² with copper or tinned stranded wires

Insulation Type:
PVC suitable for temperatures up to 70 °C / 105 °C

Insulation Diameter Range:
2.0–2.8 mm

Temperature Range:
–25 °C up to +105 °C

Wire Extraction Force/Way:
50 N min. on wire size 0.5 mm²

Application Specification:
114-20025

Product Specification:
108-20067

Printed Circuit Board:
Thickness 1.5^{+0.2}mm

Tinned Circuit Paths:
5.0mm pitch and width of 1.8mm

AMP MONO-SHAPE PCB (Printed Circuit Board) Connector

PCB Connector

- 1 PC board
- 2 First circuit path
- 3 AMP MONO-SHAPE connector
- 4 Wire

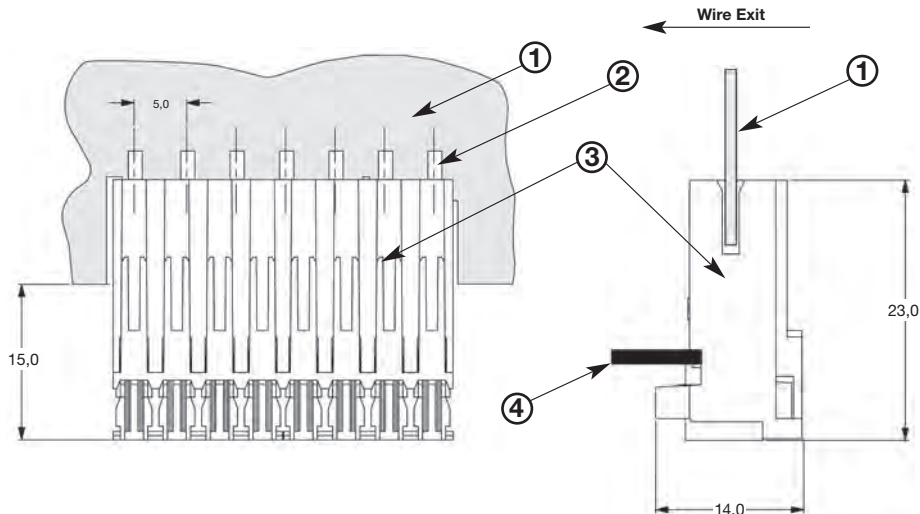

2

AMP MONO-SHAPE

Notes Concerning the PC Board Layout

- 1 First circuit path
- 2 Slot for keying rib in front of first cavity (according to the connector 4.0 mm or 7.4 mm)
- 3 Bore hole for locking clip symmetric between two cavities (diameter 2.5 mm)
- 4 Slot for keying rib symmetric between two cavities

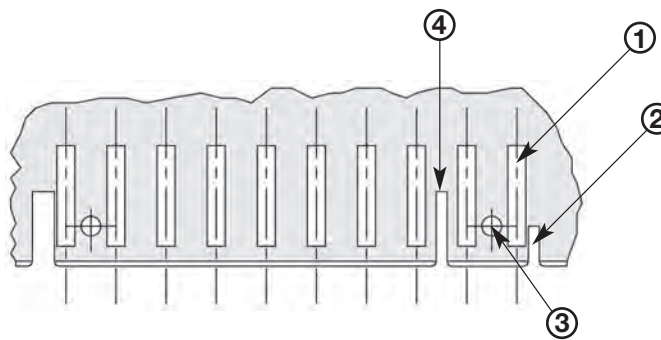

**PC Board Layout
Dimensions on request.**

See Customer Drawing 282042

AMP MONO-SHAPE PCB (Printed Circuit Board) Connector

Centerline 5.0 mm

No. of Positions Colour Marking	PC Board Cut-Out	Part Numbers		
		On Tray	Loose Piece	On Reel
2 Brown		1-282042-1	-	-
2 Green		1-282042-2	2-282042-2	-
2 Blue		1-282042-3	2-282042-3	-
2 Red		1-282042-4	2-282042-4	-
2 Black		1-282042-5	2-282042-5	-
2 Violet		1-282042-6	-	-
2 Green		1-284561-1	-	-
2 Natural		1-284561-2	-	-
3 Brown		1-282043-2	2-282043-2	-
3 Blue		1-284546-1	-	-
4 Natural		1-282044-1	2-282044-1	3-282044-1

AMP MONO-SHAPE PCB (Printed Circuit Board) Connector

Centerline 5.0 mm

No. of Positions Colour Marking	PC Board Cut-Out	Part Numbers		
		On Tray	Loose Piece	On Reel
5 Natural		1-282045-1	-	-
5 Green		1-282045-2	-	-
5 Natural		1-282045-3	2-282045-3	-
5 Natural		1-284733-1	-	-
6 Natural		1-282046-1	-	-
7 Natural		1-282047-1	2-282047-1	-
8 Natural		0-284208-1	-	-
9 Natural		1-282049-1	-	-
10 Natural		1-282050-1	2-282050-1	-
10 Black		1-284401-1	-	-
12 Natural		1-282052-1	2-282052-1	-

2

AMP MONO-SHAPE

AMP MONO-SHAPE Single Way Connector

Single Way Connector

- 1 All single way connectors are supplied in "stick-form" by 6 single ways each. They will be cut from the application tooling machines
- 2 Cover closed after wire insertion. Wire direction 90°. 180° when locked in cover recess
- 3 Polarisation similar to the keying of the front side
- 4 Keying
- 5 Plastic noses which lock into the tab hole

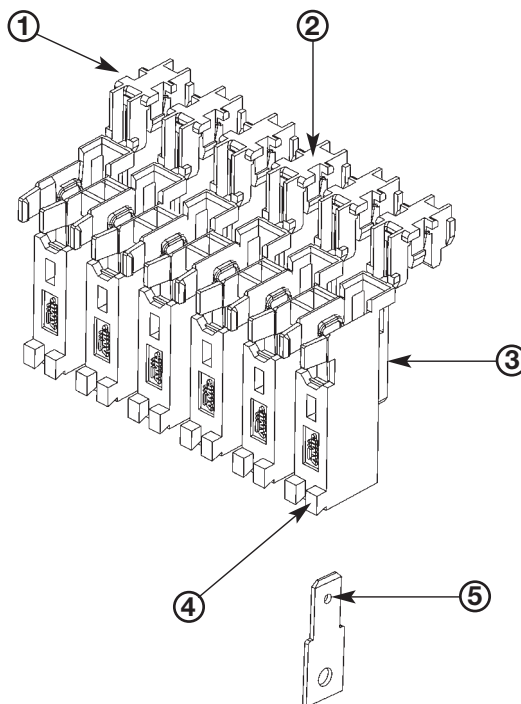

Technical Features

Centerline:
5.0 mm, according to RAST 5 specifications

Configurations:
1 position

Housing Material:
Plastic PA 6.6

Housing Colour:
Natural colour

Contact Material:
Copper alloy, post-tinned
2.0 µm min.

Polarisation, Keying, Locking Latches:
according to RAST 5 specifications
(see customer drawings)

Track Resistance:
as per IEC 112 (250 V)

Glow Wire Test:
IEC 60695-2-11; GWT (Glow Wire Test) 750 °C without flame

Air and Creepage Distance:
according to EN 60998-1 (IEC 998-1) for 380 V, ≥4.0 mm

Voltage Resistance:
according to EN 60998-1 (IEC 998-1) 1750 V for 4 minutes

Insulation Resistance:
according to EN 60998-1 (IEC 998-1) >5 MΩ

Wire Size Range:
from 0.5 to 1.5 mm²

Current Rating:
Standard Version
16 A max. according to wire size
0.5 mm² ≤ 3 A, 0.75 mm² ≤ 6 A,
1.0 mm² ≤ 10 A, 1.5 mm² ≤ 16 A

Rated Voltage:
380 Volts max.

Wire Type:
H05V-K (70 °C max.)
or FR 3/2 (105 °C max.)
for 0.5–1.0 mm² wires with copper or tinned stranded wires
H07V-K (70 °C max.)
or FR 3/2 (105 °C max.)
for wires from 1.5 mm² with copper or tinned stranded wires

Insulation Type:
PVC suitable for temperatures up to 70 °C / 105 °C

Insulation Diameter Range:
2.0–3.5 mm

Temperature Range:
–25 °C up to +105 °C

Wire Extraction Force/Way:
50 N min. on wire size 0.5 mm²

Application Specification:
114-20017

Product Specification:
108-20066

Homologations:
acc.to UL File No. E28476 (to 14 A)

Counter Part:
Tab 6.3 x 0.8 mm
as per DIN 46244 norms

Materials:
Copper alloy

Finishing:
Tinned (6.0 µm max.)

Keying Plan from Mating Direction

Keying Plan

- 1 Keying rib
- 2 Polarisation rib
- 3 Cavity number

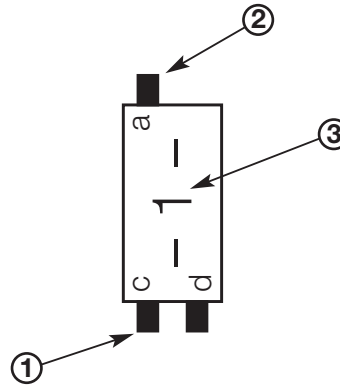

2
AMP MONO-SHAPE



AMP MONO-SHAPE
Single Way Connector

Single Piece Version



Suitable for RAST 5 Version Colour Marking	RAST 5 Version	Part Number GWT 750°C No Flame + UL94 V2	
		On Tray	On Reel
Natural		1-282086-1	-
Black		1-282086-2	-
Orange		1-282086-3	-
Green		1-282086-4	-
Blue		1-282086-5	-
Violet		1-282086-6	-

Keying Plan from Mating Direction

Single Piece Version

Suitable for RAST 5 Version Colour Marking	RAST 5 Version	Part Number GWT 750°C No Flame + UL94 V2	
		On Tray	On Reel
-		1-282086-7	
Black		1-282086-8	
Orange		1-282086-9	

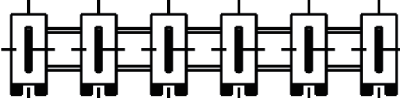
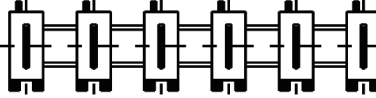
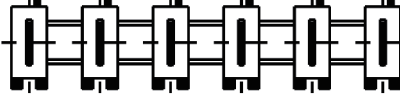
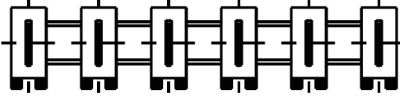
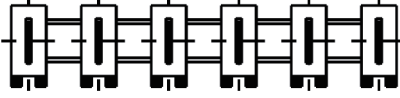
Stick Version (6*1)

Suitable for RAST 5 Version Colour Marking	RAST 5 Version	Part Number GWT 750°C No Flame + UL94 V2	
		On Tray	On Reel
-		1-282086-1	-
Black		1-282086-2	-
Orange		1-282086-3	-
Green		1-282086-4	-
Blue		1-282086-5	-
Violet		1-282086-6	-

AMP MONO-SHAPE Satellite Connector

- 1 Cover closed after wire insertion. Wire direction 90°. 180° when locked in cover recess
- 2 Bridge between contacts to have short circuit
- 3 Cavity numbers
- 4 For satellite version, the cavity 1 only accept tab contact, other cavities are clogged

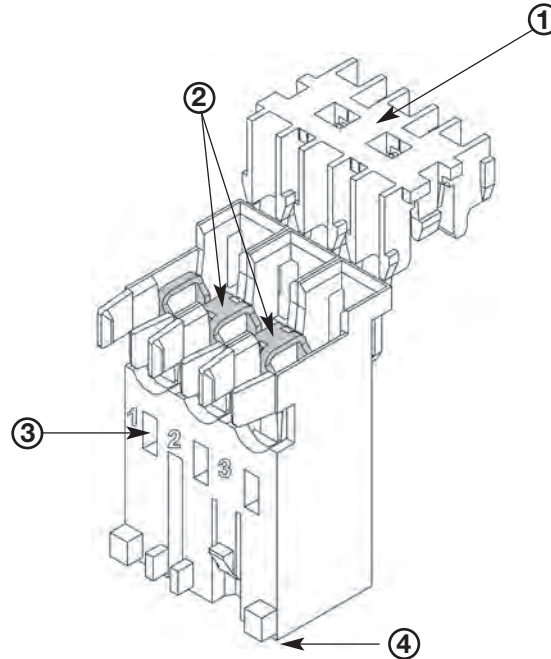

2

AMP MONO-SHAPE

Technical Features

Centerline:
5.0 mm, according to RAST 5 specifications

Configurations:
3 positions only (for special version please contact Tyco Electronics)

Housing Material:
Plastic PA 6.6

Housing Colour:
Natural colour

Contact Material:
Copper alloy, post-tinned 2.0 µm min.

Polarisation, Keying, Locking Latches:
according to RAST 5 specifications (see customer drawings)

Track Resistance:
as per IEC 112 (250 V)

Glow Wire Test:
as per IEC 60695-2-11; GWT (Glow Wire Test) 750 °C without flame

Air and Creepage Distance:
according to EN 60998-1 (IEC 998-1) for 380 V, ≥4.0 mm

Voltage Resistance:
according to EN 60998-1 (IEC 998-1) 1750 V for 4 minutes

Insulation Resistance:
according to EN 60998-1 (IEC 998-1) >5 MΩ

Wire Size Range:
from 0.5 to 1.5 mm²

Current Rating:
16 A max. according to wire size
0.5 mm² ≤3 A, 0.75 mm² ≤6 A, 1.0 mm² ≤10 A, 1.5 mm² ≤16 A

Rated Voltage:
380 Volts max.

Wire Type:
H05V-K (70 °C max.)
or FR 3/2 (105 °C max.)
for 0.5–1.0 mm² wires with copper or tinned stranded wires

H07V-K (70 °C max.)
or FR 3/2 (105 °C max.)
for wires from 1.5 mm² with copper or tinned stranded wires

Insulation Type:
PVC suitable for temperatures up to 70 °C / 105 °C

Insulation Diameter Range:
2.0–3.5 mm

Temperature Range:
–25 °C up to +105 °C

Wire Extraction Force/Way:
50 N min. on wire size 0.5 mm²

Application Specification:
114-20026

Product Specification:
108-20070

Homologations:
acc. to UL File No. E28476 (to 14 A)

Keying Plan from Mating Direction

Keying Plan

- 1 Locking latch
- 2 Keying rib
- 3 Polarisation rib
- 4 Cavity number

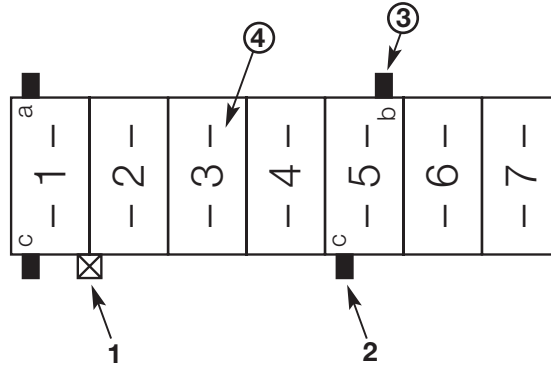

AMP MONO-SHAPE - 2 Position Satellite Connector

(Variable Keying)* Bridge between contacts. Cavity numbers 1-2 to have short circuit

Suitable for RAST 5 Version Colour Marking	RAST 5 Version	Part Numbers		
		On Tray	Loose Piece	On Reel
02-L 02-P Natural		-	284288-1	-

AMP MONO-SHAPE - 3 Position Satellite Connector

(Variable Keying)*

Suitable for RAST 5 Version Colour Marking	RAST 5 Version	Part Numbers		
		On Tray	Loose Piece	On Reel
- Black		1-284289-2	284289-2	-
03-A 03-I Black		1-282099-1	-	-

AMP MONO-SHAPE - 6 Position Satellite Connector

(Variable Keying)*

Suitable for RAST 5 Version Colour Marking	RAST 5 Version	Part Numbers		
		On Tray	Loose Piece	On Reel
Natural		1-284744-1	-	-

* Final keying version is produced on the application tooling machines.

Introduction

AMP Standard Timer Connectors in In-Line Mating Technology

AMP standard timer connectors according to rast 5.0 mm standard have been developed to connect rast 5 components (like motors, leach pumps, water level regulators, relays and push-button switches) in the household appliances industry.

They meet industry requirements, for example multiple position connectors, secure connection even at inclining mating as well as a sturdy contact design.

AMP standard power timer contacts, for use with standard timer housings, are suitable for high density and high current capacity up to 16 A.

Housing is designed for end-to-end stacking without contact loss. They are available in different keying and locking versions from 2- positions to 12-positions.

Standard timer contacts can be used with stranded wires from 0.5 mm² to 2.5 mm² and can be double terminated. of course, the corresponding tooling is available, too.

UL recognised component.

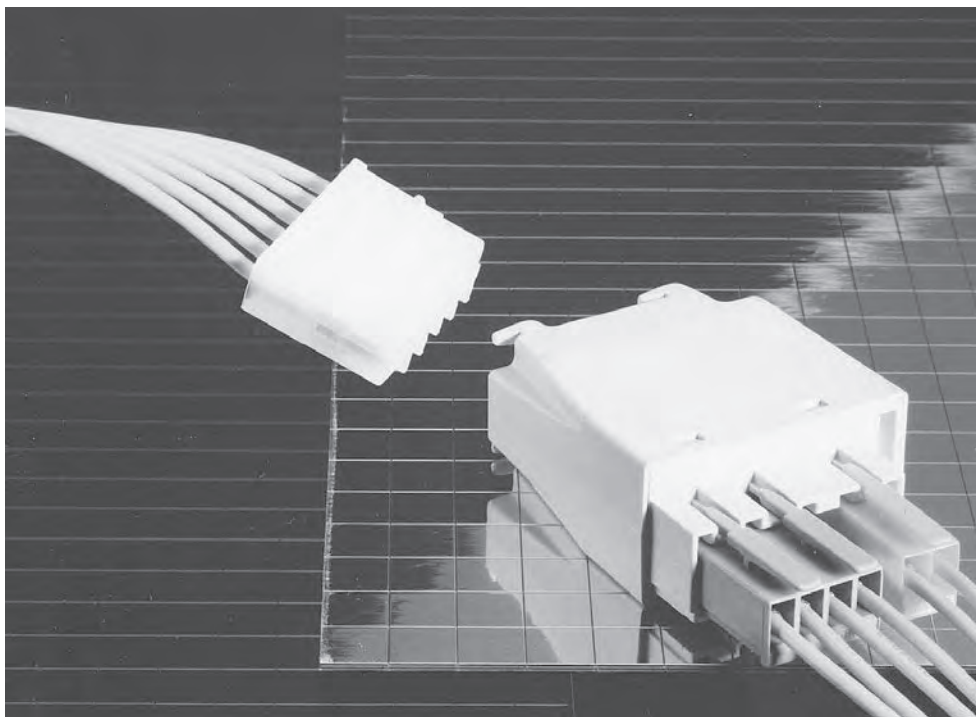

Technical Features

Centerline:
5.0 mm

Available Number of Positions:
2- to 12-positions

Housing Material:
Polyamide PA 6.6

Contact Material:
CuSn, CuFe

Contact Finish:
Tin Plated, Silver Plated

Wire Size Range:
from 0.5 to 2.5mm²

Wire Size Diameter:
from 2.0 to 3.3mm

Temperature Range:
-40°C to +110°C

Current Voltage:
220 V_~

Current Rating:
max. 16 A
Standard Timer: 6 A
Power Timer: 16 A

Mating Force Contact:
≤15 N

Unmating Force:
≤ 8 N

Air and Creepage Distance:
≥ 3.0mm

Track Resistance:
PTI 250

Glow Wire Test:
as per IEC 60695-2-11,GWT
750°C without flame

**Contacts made for Tabs
according:-**
DIN 46244
(6.3 x 0.8mm / 4.8 x 0.8mm)
DIN 46343 Part 2 and 3

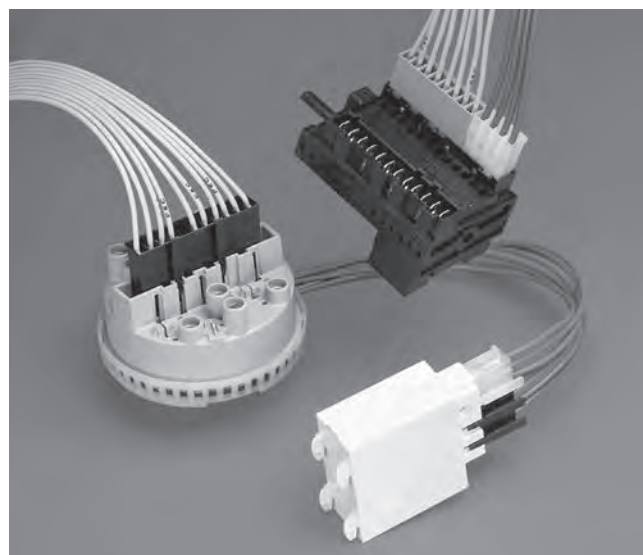

Interior and Exterior Locking

Interior Locking

Connection to the components according RAST 5 standard

- 1 Connected timer contact
- 2 Standard timer housing with interior locking
- 3 Keying
- 4 Polarisation
- 5 Locking latch
- 6 Cover (secondary locking)
- 7 RAST 5 tab array

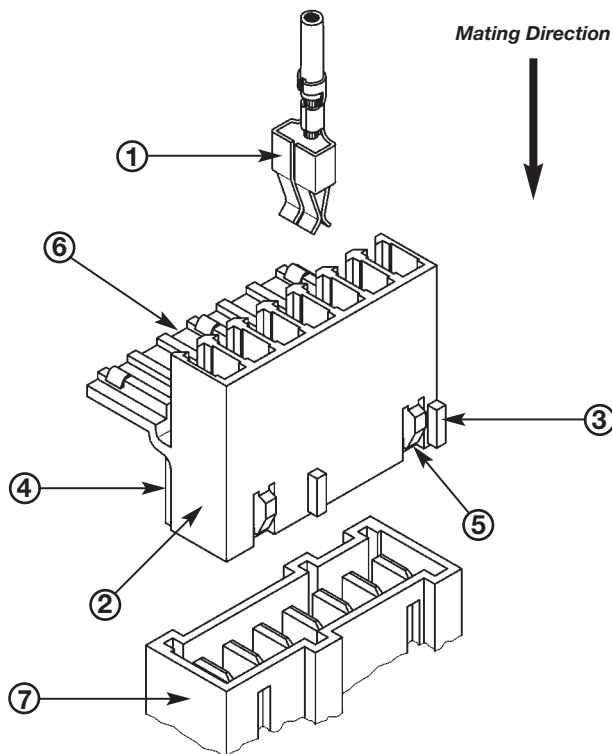

Exterior Locking

Connection to the components according RAST 5 standard

- 1 Connected timer contact
- 2 Standard timer housing with interior locking
- 3 Keying
- 4 Polarisation
- 5 Locking latch
- 6 RAST 5 tab array

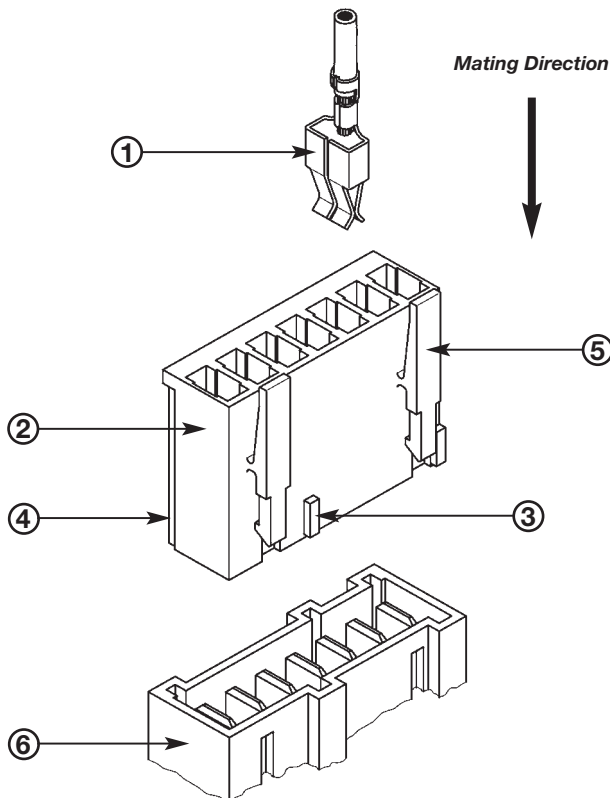

Keying Plan and Housings

Keying Plan
from Mating Direction

- 1 Locking latch
- 2 Keying rib
- 3 Keying rib between cavity
- 4 Slanted keying rib
- 5 Polarisation rib
- 6 Cavity number

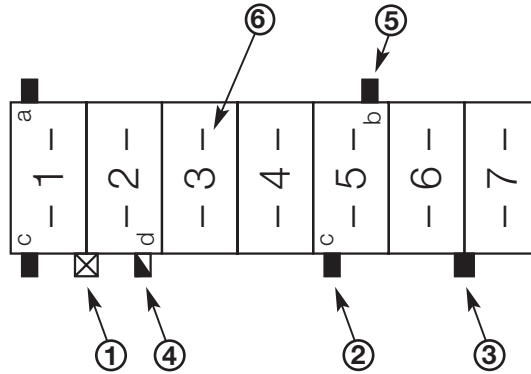

2 Position RAST 5 Variations

UL 94 V2			GWT 750°C No Flame + UL94 V2		
Keying Version Colour	RAST5 version	Part Number	Keying Version Colour	RAST5 version	Part Number
- Natural		969484-1	- Natural		1241961-1
- Natural		969484-2	02-P Natural		1241961-3
- Natural		969484-3	02-F Natural		2-1241961-2
- Natural		1-969484-1	- Natural		3-1241961-1
- Natural		2-969484-1	02-D Natural		3-1241961-2
02-F Natural		2-969484-2	02-C Natural		4-1241961-3
- Natural		3-969484-1	- Natural		5-1241961-2
02-D Natural		3-969484-2	02-G Natural		5-1241961-3

Bold Part Numbers Are Types That Meet UL 94 V0 Standard

Dimensions are shown for reference purposes only.









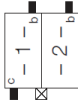
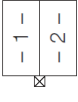

Dimensions are in inches and millimetres unless otherwise specified. Values in brackets are metric equivalents.

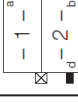
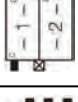
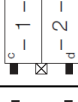
All specifications subject to change. Consult TE for latest specifications.

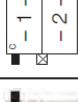
www.te.com/industry/appliances

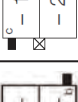
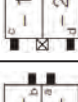
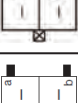
Housings—Exterior Lock

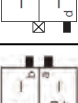
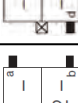
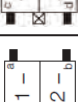
2 Position RAST 5 Variations

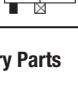
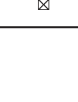
UL 94 V2			GWT 750°C No Flame + UL94 V2		
Keying Version Colour	RAST5 version	Part Number	Keying Version Colour	RAST5 version	Part Number
- Natural		4-969484-1	02-I Natural		6-1241961-2
- Natural		4-969484-2	02-L Natural		6-1241961-3
02-C Natural		4-969484-3	02-E Natural		7-1241961-2
- Natural		5-969484-2	02-Q Natural		7-1241961-3
02-G Natural		5-969484-3	02-B Natural		8-1241961-2
- Natural		6-969484-1	- Natural		8-1241961-3
02-I Natural		6-969484-2	02-A Natural		9-1241961-2
02-L Natural		6-969484-3	02-A Natural		1241965-2
02-E Natural		7-969484-2	02-G Natural		3-1241965-2
02-A Natural		9-969484-2	02-E Natural		6-1241965-2
02-B Black		928247-2	- Natural		9-1241965-2

Bold Part Numbers Are Preliminary Parts

Housings—Exterior Lock

2 Position RAST 5 Variations











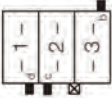









UL 94 V2			GWT 750°C No Flame + UL94 V2		
Keying Version Colour	RAST5 version	Part Number	Keying Version Colour	RAST5 version	Part Number
02-O Pink		2-928247-2	- Yellow		1241983-2
02-I Orange		3-928247-2	- Violet		1-1241983-2
02-K Yellow-Green		4-928247-2	- Green		2-1241983-2
02-E Green		5-928247-2	02-G Blue		5-1241983-3
02-A Natural		6-928247-2	02-I Red		6-1241983-2
02-C Grey		8-928247-2	02-B Black		8-1241983-2
- Natural		9-928247-2	- -	-	-
02-G Violet		2-964983-2	- -	-	-
02-M Ultramarine-Blue		3-964983-2	- -	-	-

Bold Part Numbers Are Preliminary Parts

3
AMP Standard Timer

Housings—Exterior Lock

3 Position RAST 5 Variations

UL 94 V2			GWT 750°C No Flame + UL94 V2		
Keying Version Colour	RAST5 version	Part Number	Keying Version Colour	RAST5 version	Part Number
- Natural		969484-8	- Natural		1241961-6
- Natural		1-969484-7	- Natural	-	1241961-7
- Natural		2-969484-6	- Natural		1-1241961-7
03-C Natural		2-969484-8	03-A Natural		2-1241961-7
- Natural		3-969484-6	03-F Natural		3-1241961-7
- Natural		3-969484-7	03-I Natural		4-1241961-7
- Natural		5-969484-7	03-G Natural		6-1241961-7
- Natural		7-969484-6	- Natural		1241961-8
- Natural		8-969484-6	03-D Natural		1-1241961-8
- Natural		8-969484-7	03-C Natural		2-1241961-8
- Natural		9-969484-6	- Natural		3-1241961-8

Bold Part Numbers Are Preliminary Parts

Housings—Exterior Lock

3 Position RAST 5 Variations

UL 94 V2			GWT 750°C No Flame + UL94 V2		
Keying Version Colour	RAST5 version	Part Number	Keying Version Colour	RAST5 version	Part Number
- Yellow		9-969484-9	- Natural		4-1241961-8
- Yellow		928247-3	- Natural		5-1241961-8
- Natural		5-928247-3	- Natural		6-1241961-8
03-K Green		2-1241817-3	- Natural		7-1241961-8
- Natural	-	-	- Natural		8-1241961-8
- Natural	-	-	- Natural		9-1241961-8
- Natural	-	-	- Natural		9-1241961-9
- Natural	-	-	- Natural		1241965-3
- Natural	-	-	- Natural		5-1241965-3

Bold Part Numbers Are Preliminary Parts

Housings—Exterior Lock

4 Position RAST 5 Variations

UL 94 V2			GWT 750°C No Flame + UL94 V2		
Keying Version Colour	RAST5 version	Part Number	Keying Version Colour	RAST5 version	Part Number
04-C Grey		928247-4	04-C Natural		1241965-4
04-F White		2-928247-4	04-A Natural		1241959-4
03-G Violet		3-928247-4	04-C Natural		2-1241959-4
04-A Natural		4-928247-4	- Natural		4-1241959-4
04-B Black		5-928247-4	-	-	-
04-A Natural		1241817-4	-	-	-

Bold Part Numbers Are Preliminary Parts

Housings—Exterior Lock

5 Position RAST 5 Variations

UL 94 V2			GWT 750°C No Flame + UL94 V2		
Keying Version Colour	RAST5 version	Part Number	Keying Version Colour	RAST5 version	Part Number
05-B Black		2-928247-5	- Natural		1241965-5
05-D Blue		3-928247-5	05-B Natural		2-1241965-5
- Green		5-928247-5	05-B Natural		1241959-5
- Natural		6-928247-5	-	-	-

Bold Part Numbers Are Preliminary Parts

6 Position RAST 5 Variations

UL 94 V2			GWT 750°C No Flame + UL94 V2		
Keying Version Colour	RAST5 version	Part Number	Keying Version Colour	RAST5 version	Part Number
06-C Grey		928247-6	06-A Natural		1241965-6
06-D Blue		2-928247-6	06-D Natural		2-1241965-6
06-A Natural		964983-6	-	-	-

Bold Part Numbers Are Preliminary Parts

Housings—Exterior Lock

7 Position RAST 5 Variations

UL 94 V2			GWT 750°C No Flame + UL94 V2		
Keying Version Colour	RAST5 version	Part Number	Keying Version Colour	RAST5 version	Part Number
07-C Grey		928247-7	- Natural		1241965-7
-	-	-	- Natural		1-1241965-7
-	-	-	07-C Natural		2-1241965-7

Bold Part Numbers Are Preliminary Parts

8 Position RAST 5 Variations

UL 94 V2			GWT 750°C No Flame + UL94 V2		
Keying Version Colour	RAST5 version	Part Number	Keying Version Colour	RAST5 version	Part Number
08-D Blue		928247-8	08-D Natural		1241965-8

Bold Part Numbers Are Preliminary Parts

9 Position RAST 5 Variations

UL 94 V2			GWT 750°C No Flame + UL94 V2		
Keying Version Colour	RAST5 version	Part Number	Keying Version Colour	RAST5 version	Part Number
-	-	-	09-D Natural		1241965-9

Bold Part Numbers Are Preliminary Parts

Housings—Exterior Lock

10 Position RAST 5 Variations

UL 94 V2			GWT 750°C No Flame + UL94 V2		
Keying Version Colour	RAST5 version	Part Number	Keying Version Colour	RAST5 version	Part Number
- Brown		1-928247-0	- -	-	-
- Grey		2-928247-0	- -	-	-

Bold Part Numbers Are Preliminary Parts

11 Position RAST 5 Variations

UL 94 V2			GWT 750°C No Flame + UL94 V2		
Keying Version Colour	RAST5 version	Part Number	Keying Version Colour	RAST5 version	Part Number
11-B Black		1-928247-1	11-B Natural		1-1241965-1

Bold Part Numbers Are Preliminary Parts

Housings—Exterior Lock

2 Position RAST 5 Variations

UL 94 V0		
Keying Version Colour	RAST5 version	Part Number
02-K Natural		2178029-2
02-I Natural		1-2178029-2
02-B Natural		2-2178029-2
- Natural		1955422-1
02-C Natural		4-1955422-3

3 Position RAST 5 Variations

UL 94 V0		
Keying Version Colour	RAST5 version	Part Number
- Natural		2178029-3
- Yellow		9-2178029-3
- Natural		1955422-6
- Natural		1-1955422-7
- Natural		5-1955422-7

Bold Part Numbers Are Preliminary Parts

4 Position RAST 5 Variations

UL 94 V0		
Keying Version Colour	RAST5 version	Part Number
- Natural	-	4-2178029-4
- Natural		9-928247-4

5 Position RAST 5 Variations

UL 94 V0		
Keying Version Colour	RAST5 version	Part Number
- Natural	-	2-2178029-5
- Natural	-	5-2178029-5

Bold Part Numbers Are Preliminary Parts

Housings—Exterior Lock

7 Position RAST 5 Variations

UL 94 V0			UL 94 V0		
Keying Version Colour	RAST5 version	Part Number	Keying Version Colour	RAST5 version	Part Number
- Natural		3-928247-7	-	-	-

Bold Part Numbers Are Preliminary Parts

3

AMP Standard Timer

Housings—Interior Lock

2 Position RAST 5 Variations

UL 94 V2			GWT 750°C No Flame + UL94 V2		
Keying Version Colour	RAST5 version	Part Number	Keying Version Colour	RAST5 version	Part Number
02-A Natural		928344-2	02-B Natural		2-1241964-2
02-B Black		2-928344-2	-	-	-
02-Q Turquoise		4-928344-2	- Natural		964768-3
02-E Green		6-928344-2	-	-	-
02-G Black		7-928344-2	-	-	-
02-B Gray		8-928344-2	-	-	-
02-I Red		9-928344-2	-	-	-
02-O Pink		964951-2	-	-	-
02-C Grey		3-964951-2	-	-	-
02-L Natural		928343-2	-	-	-
- Grey		964768-2	-	-	-

Part Numbers In Pink Are Special Versions

Housings—Interior Lock

3 Position RAST 5 Variations

UL 94 V2			GWT 750°C No Flame + UL94 V2		
Keying Version Colour	RAST5 version	Part Number	Keying Version Colour	RAST5 version	Part Number
03-A Natural		928344-3	-	-	-
- Grey		2-928344-3	-	-	-
- Natural		928343-3	-	-	-
- Grey		3-928343-3	-	-	-

Part Numbers In Pink Are Special Versions

4 Position RAST 5 Variations

UL 94 V2			GWT 750°C No Flame + UL94 V2		
Keying Version Colour	RAST5 version	Part Number	Keying Version Colour	RAST5 version	Part Number
04-A Natural		928344-4	04-A Natural		1241964-4
04-C Grey		3-928344-4	-	-	-
- Black		4-928344-4	-	-	-
- Grey		5-928344-4	-	-	-
- Natural		928343-4	-	-	-

Part Numbers In Pink Are Special Versions

Dimensions are shown for reference purposes only.

Dimensions are in inches and millimetres unless otherwise specified. Values in brackets are metric equivalents.

All specifications subject to change. Consult TE for latest specifications.

www.te.com/industry/appliances

Housings—Interior Lock

5 Position RAST 5 Variations

UL 94 V2			GWT 750°C No Flame + UL94 V2		
Keying Version Colour	RAST5 version	Part Number	Keying Version Colour	RAST5 version	Part Number
- Natural		928344-5	- Natural		1241964-5
- Natural		928343-5	-	-	-
- Black		2-928343-5	-	-	-

Part Numbers In Pink Are Special Versions

6 Position RAST 5 Variations

UL 94 V2			GWT 750°C No Flame + UL94 V2		
Keying Version Colour	RAST5 version	Part Number	Keying Version Colour	RAST5 version	Part Number
- Natural		2-928344-6	06-A Natural		1241964-6
- Green		3-928344-6	-	-	-
-	-	-	-	-	-
-		928343-6	-	-	-
- Black		2-928343-6	-	-	-

Part Numbers In Pink Are Special Versions

Housings—Interior Lock

7 Position RAST 5 Variations

UL 94 V2			GWT 750°C No Flame + UL94 V2		
Keying Version Colour	RAST5 version	Part Number	Keying Version Colour	RAST5 version	Part Number
- Natural		928344-7	07-A/S Natural		1241964-7
-	-	-	-	-	-
07-A/S Natural		928151-7	-	-	-
- Natural		928343-7	-	-	-
- Black		2-928343-7	-	-	-

Part Numbers In Pink Are Special Versions

8 Position RAST 5 Variations

UL 94 V2			GWT 750°C No Flame + UL94 V2		
Keying Version Colour	RAST5 version	Part Number	Keying Version Colour	RAST5 version	Part Number
- Natural		928343-8	-	-	-
- Black		2-928343-8	-	-	-
- Grey		3-928343-8	-	-	-

Part Numbers In Pink Are Special Versions

3 AMP Standard Timer

Housings—Interior Lock

9 Position RAST 5 Variations

UL 94 V2			GWT 750°C No Flame + UL94 V2		
Keying Version Colour	RAST5 version	Part Number	Keying Version Colour	RAST5 version	Part Number
- Natural		928343-9	-	-	-
- Natural	-	1703060-9	-	-	-

Part Numbers In Pink Are Special Versions

11 Position RAST 5 Variations

UL 94 V2			GWT 750°C No Flame + UL94 V2		
Keying Version Colour	RAST5 version	Part Number	Keying Version Colour	RAST5 version	Part Number
- Natural		1-928343-1	-	-	-

Part Numbers In Pink Are Special Versions

12 Position RAST 5 Variations

UL 94 V2			GWT 750°C No Flame + UL94 V2		
Keying Version Colour	RAST5 version	Part Number	Keying Version Colour	RAST5 version	Part Number
- Natural		1-928343-2	-	-	-

Part Numbers In Pink Are Special Versions

Standard Timer Connector and Contacts

Technical Data

Material:

Brass, Tin Plated

Mating Part:

6.3 Tab

Wire:

FLK 0.5/0.75 and 1.5mm²

Current Carrying Capacity to 6A:

- 1 = Wire 0.50mm², 11pos. housing
- 2 = Wire 0.75mm², 11pos. housing
- 3 = Wire 0.50mm², 2pos. housing
- 4 = Wire 0.75mm², 2pos. housing

Current Carrying Capacity to 16A:

- 5 = Wire 1.50mm², 11pos. housing
- 6 = Wire 1.50mm², 2pos. housing

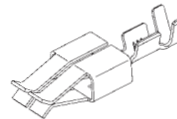
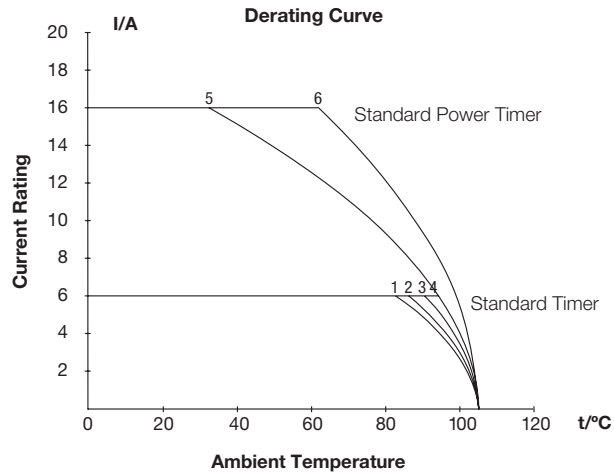

Standard Timer Contacts with One Locking Lance

Wire Size Range (mm ²)	Insulation Diameter Range (mm)	Material	Finish	Part Number	Packaging Unit
0.5-1.0	1.4-2.3	CuZn/Brass	Tin Plated	928820-1	3.000
1.0-2.5	3.0-4.3	CuZn/Brass	Tin Plated	926973-1	2.500

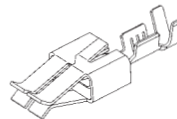

Standard Timer Contacts with Two Locking Lances

Wire Size Range (mm ²)	Insulation Diameter Range (mm)	Material	Finish	Part Number	Packaging Unit
0.5-1.0	1.4-2.3	CuZn/Brass	Tin Plated	964201-1	3.000
1.0-2.5	3.0-4.3	CuZn/Brass	Tin Plated	964202-1	2.000

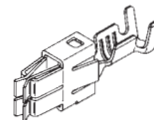

Standard Power Timer

Wire Size Range (mm ²)	Insulation Diameter Range (mm)	Material	Finish	Part Number	Packaging Unit
1.0-2.5	2.2-3.0	CuFe/Copper Iron	Tin Plated	964203-1	2.300
1.0-2.5	2.2-3.0	CuFe/Copper Iron	Silver Plated	964203-5	2.300
1.5-3.0	max. 2 x 3.0	CuFe/Copper Iron	Tin Plated	964204-1	2.000
1.5-3.0	max. 2 x 3.0	CuFe/Copper Iron	Silver Plated	964204-5	2.000
0.80 -1.30	2.0-2.8	CuFe2/Copper Iron	Tin Plated	1862006-1	2.300
0.80 -1.30	2.0-2.8	CuFe2/Copper Iron	Silver Plated	1862006-5	2.300

Bold Part Numbers Are Preferred Types

Introduction

Product Facts

- Meets IEC 60335-1, Glow Wire 750° No flame
- Accepts FASTIN-FASTON tabs 6.3 x 0.8 mm size
- Mating connector families include AMP MONO-SHAPE, AMP multifitting, AMP standard timer and Positive Lock RAST 5 connector systems
- Available in different keying and locking versions, from 2 to 10 positions
- Available for panel and motor mounting
- Provided with secondary locking
- RoHS compliant

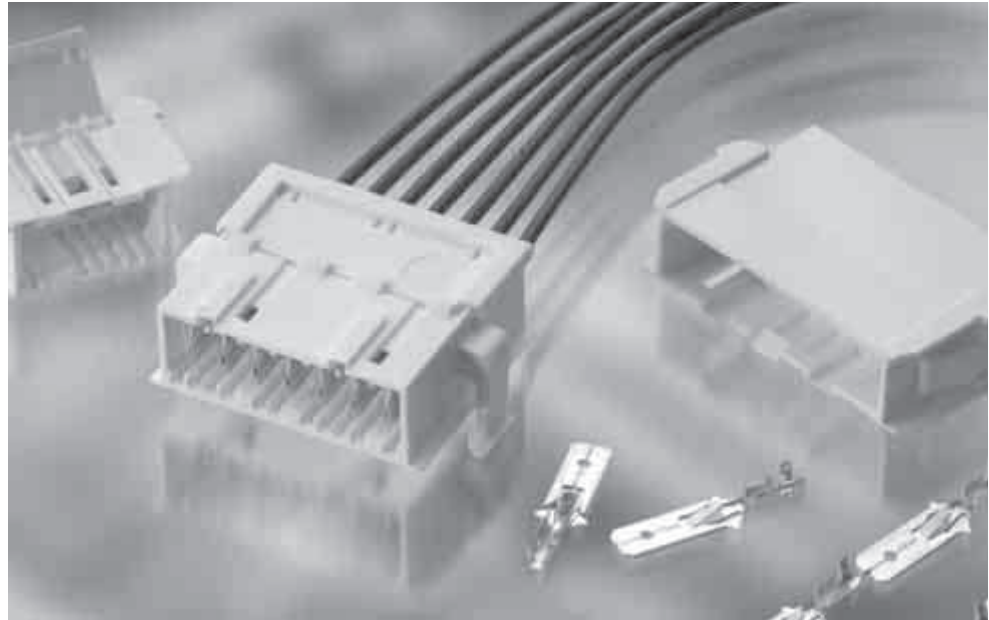

Technical Documents Product Specifications

108-20256 Panel
Mount Housings

108-20247 Panel
Mount Housings

The RAST 5 standard defines and standardizes the connector mating interface. FASTIN-FASTON 6.3 mm size tabs are placed into 5 mm centerline cavities and the housings are provided with keying, polarization, and locking features that help prevent mismatching of the corresponding RAST 5 connector interfaces.

The FASTIN-FASTON RAST 5 connector system is designed to accept the most common RAST 5 connector families including AMP MONO-SHAPE, AMP multifitting, AMP standard timer and Positive Lock RAST 5 connector systems. The Positive Lock RAST 5 connector system requires the use of a FASTIN-FASTON tab with a special detent hole location to engage the positive locking feature.

The most common application for this product is for household appliance components (motors for washing machines, dishwashers, dryers, refrigerators...) where OEM's want to minimize the possibility of crossed wires.

FASTIN-FASTON Tab Housings RAST 5

Technical Features

- ① Locking tongue locks with the keying rib of the counter part (see table)
- ② Locking window locks with locking latches of the counter part (see table)
- ③ Keying groove
- ④ Polarization groove
- ⑤ Cover (secondary locking)
- ⑥ Panel locking
 - Ⓐ For panel thickness from 0.8 up to 1.0 mm
 - Ⓑ For panel thickness from 1.0 up to 2.2 mm
- ⑦ Tabs 6.3 x 0.8 mm (see table)

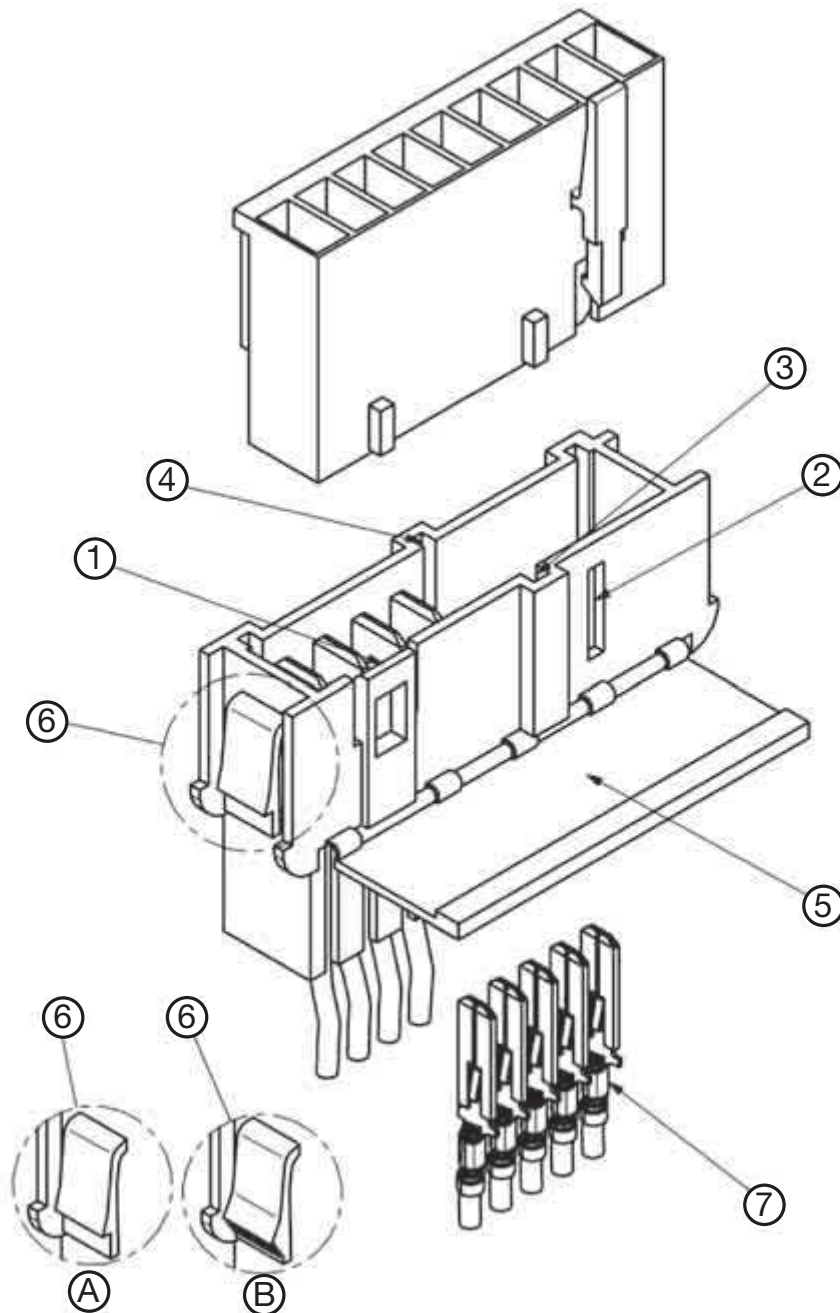

4
FASTIN-FASTON RAST 5

Panel Cut-Outs

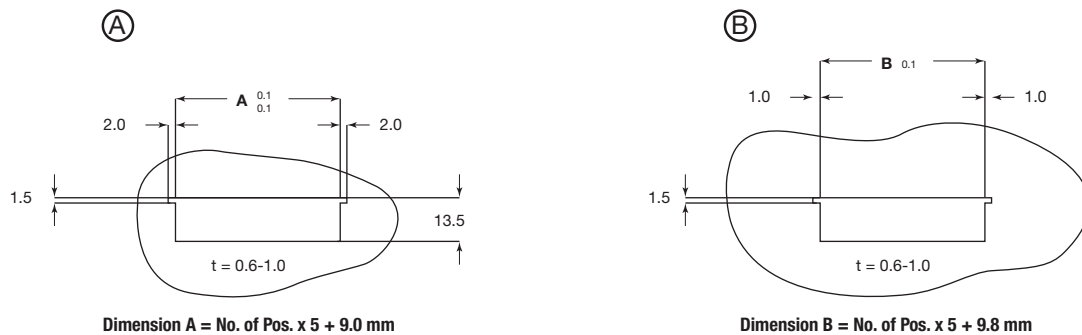

Pannel Mount Housing

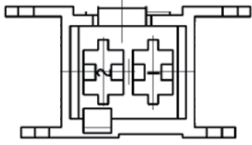
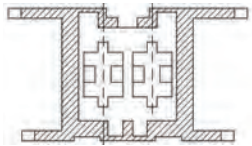
Pos.	RAST5 Polarization	Panel Cut-Out	Style	UL 94	Note	Colour	Part Number
2		A	C	V2	-	Natural	927742-2
		A	C	V2	GWT 750°C No Flame	Natural	9-927742-2
		A	D	V2	GWT 750°C No Flame	Natural	293035-2
		A	D	V2	-	Natural	5-293035-2
		A	C	V2	GWT 750°C No Flame	Natural	8-927742-2
		A	C	V2	-	Natural	928230-2

Pannel Mount Housing

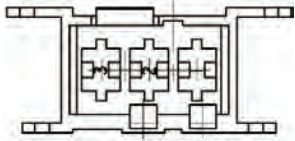
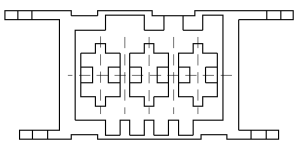
Pos.	RAST5 Polarization	Panel Cut-Out	Style	UL 94	Note	Colour	Part Number
3		A	C	V2	-	Natural	927742-3
		A	C	V2	-	Grey	2-927742-3
		A	C	V0	-	Natural	5-927742-3
		A	C	V2	GWT 750°C No Flame	Natural	9-927742-3
		A	C	V2	GWT 750°C No Flame	Natural	293008-1
		A	C	V2	-	Natural	293008-2
		A	C	V0	-	Natural	293008-3
		A	C	V0	GWT 750°C No Flame	Natural	293008-5

4

FASTIN-FASTON RAST 5

Pannel Mount Housing

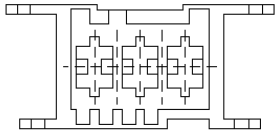
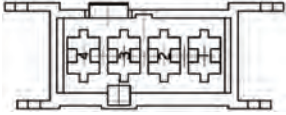
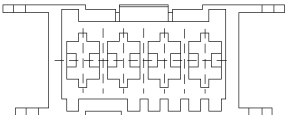
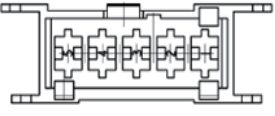
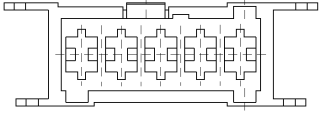
Pos.	RAST5 Polarization	Panel Cut-Out	Style	UL 94	Note	Colour	Part Number	
3		A	C	V2	GWT 750°C No Flame	Natural	1955416-1	
4		A	C	V2	-	Natural	927742-4	
		A	C	V2	GWT 750°C No Flame	Natural	9-927742-4	
5		A	C	V2	GWT 750°C No Flame	Natural	293009-1	
		A	C	V0	GWT 750°C No Flame	Natural	293009-3	
5		A	C	V2	-	Natural	927742-5	
5		A	C	V2	GWT 750°C No Flame	Natural	293011-1	

Pannel Mount Housing

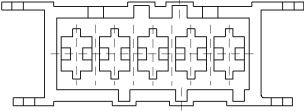
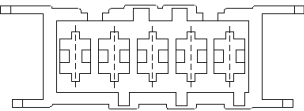
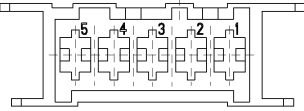
Pos.	RAST5 Polarization	Panel Cut-Out	Style	UL 94	Note	Colour	Part Number
5		A	C	V2	-	Natural	293011-2
		A	C	V2	GWT 750°C No Flame	Natural	293010-1
		A	C	V2	-	Natural	293010-2
		A	C	V0	-	Natural	293010-3
		A	C	V0	GWT 750°C No Flame	Natural	293010-4
		B	C	V2	GWT 750°C No Flame	Natural	1241857-5
		A	C	V2	-	Natural	293161-1
		A	C	V2	GWT 750°C No Flame	Natural	293161-2

4

FASTIN-FASTON RAST 5

Panel Mount Housing

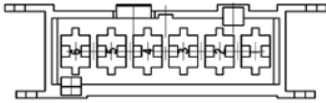
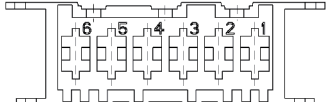
Pos.	RAST5 Polarization	Panel Cut-Out	Style	UL 94	Note	Colour	Part Number
6		A	C	V2	-	Natural	927742-6
		A	C	V0	-	Natural	5-927742-6
		A	C	V0	-	Black	6-927742-6
		A	C	V2	GWT 750°C No Flame	Natural	7-927742-6
		A	C	V0	GWT 750°C No Flame	Natural	8-927742-6
7		B	D	V2	GWT 750°C No Flame	Natural	5-1241967-6
		A	C	V2	-	Natural	927742-7
		A	C	V2	-	Black	2-927742-7

Panel Mount Housing

Pos.	RAST5 Polarization	Panel Cut-Out	Style	UL 94	Note	Colour	Part Number
7		B	D	V2	GWT 750°C No Flame	Natural	5-1241967-7
		A	C	V2	GWT 750°C No Flame	Natural	293034-1
		A	C	V0	-	Natural	293034-3
		A	C	V2	GWT 750°C No Flame	Natural	293044-1
		A	C	V2	GWT 750°C No Flame	Natural	284985-1
		A	C	V2	-	Natural	928309-7
		A	C	V2	GWT 750°C No Flame	Natural	293267-1
		A	C	V2	GWT 750°C No Flame	Natural	293223-1

4

FASTIN-FASTON RAST 5

Panel Mount Housing

Pos.	RAST5 Polarization	Panel Cut-Out	Style	UL 94	Note	Colour	Part Number
8		B	D	V2	-	Natural	1241967-8
		B	D	V2	GWT 750°C No Flame	Natural	5-1241967-8
		A	C	V2	-	Natural	928309-8
		A	C	V2	GWT 750°C No Flame	Natural	284986-2
		A	C	V2	GWT 750°C No Flame	Natural	284986-1
		B	C	V2	GWT 750°C No Flame	Natural	293043-1
		A	D	V2	GWT 750°C No Flame	Natural	5-1241969-8
		A	D	V2	-	Natural	1241969-8

Panel Mount Housing

Pos.	RAST5 Polarization	Panel Cut-Out	Style	UL 94	Note	Colour	Part Number
9		B	D	V2	GWT 750°C No Flame	Natural	293033-1
10		A	D	V2	-	Natural	1-1241968-0
		A	D	V2	GWT 750°C No Flame	Natural	1-1241968-5

4
FASTIN-FASTON RAST 5

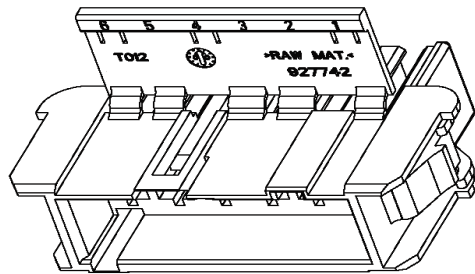

C - With Secondary Locking

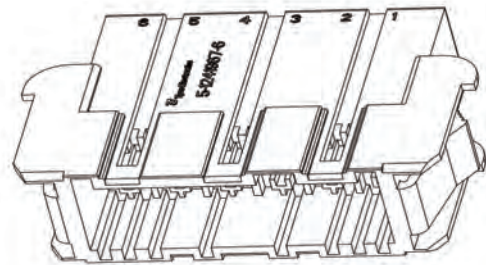

D - Without Secondary Locking

Motor Mount Housing

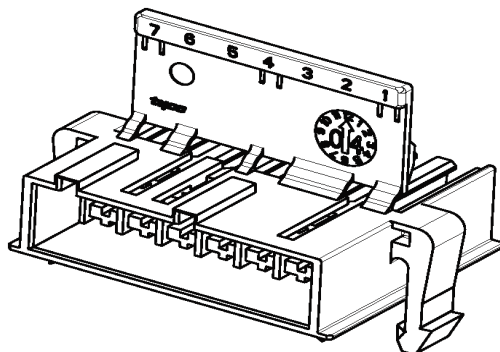

Pos.	RAST5 Polarization	Panel Cut-Out	Style	UL 94	Note	Colour	Part Number
7		-	E	V2	GWT 750°C No Flame	Natural	293014-1
		-	E	V2	GWT 750°C No Flame	Natural	0-293015-1
		-	E	V2	GWT 750°C No Flame	Natural	1-293015-1
8		-	E	V0	-	Natural	0-284861-3
		-	E	V2	GWT 750°C No Flame	Natural	0-293346-1



Style E

Positive Lock RAST 5 Connector System

Product Features

- Mates with .250 x .032 [6.35 x 0.81] tabs built on 5 mm centerlines
- Keying and polarization features
- Utilizes Positive Lock Mark III Receptacles
- Terminals available for 22-18 AWG, 18-14 AWG single wire or 18-16 AWG double wire applications
- Plain brass and tin plated terminals available
- Recognized under the Component Program of Underwriters Laboratories Inc., File No. E28476 
- Certified by Canadian Standards Association File No. LR7189 

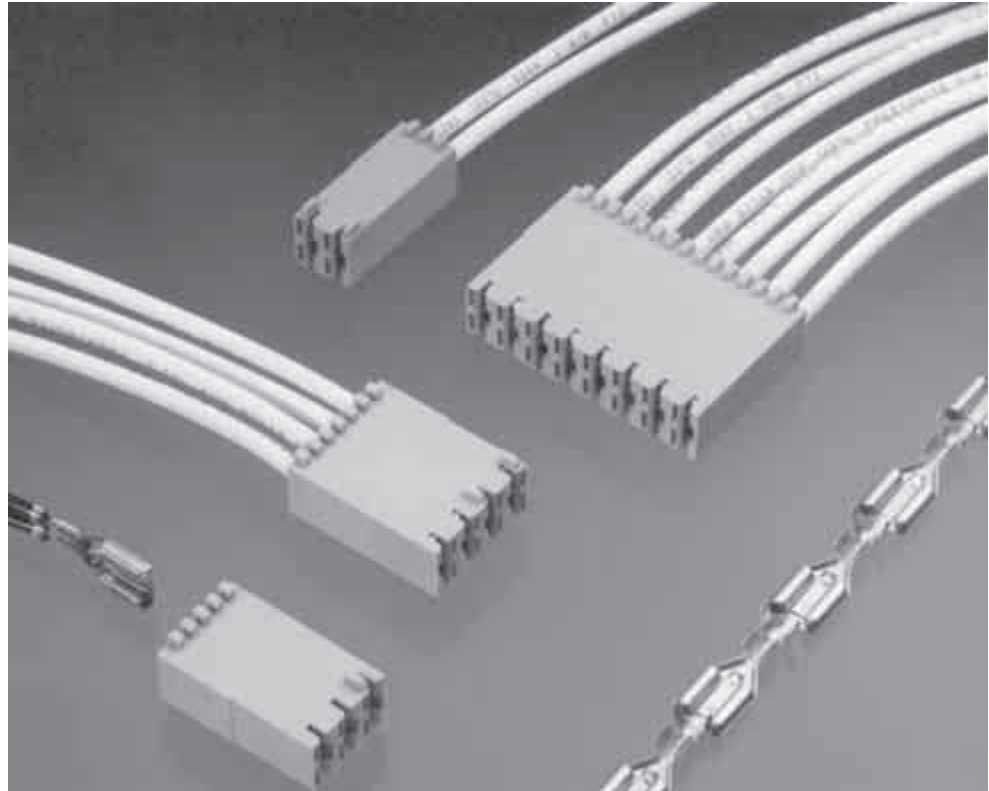

The Positive Lock RAST 5 connector system has been designed to mate with a control, switch or printed circuit board that has .250 x .032 [6.35 x 0.81] thick tabs built on 5 mm centerlines. This system utilizes our popular Positive Lock mark III receptacles and a series of housings to provide customers with a reliable solution to their wire management needs. This line of connectors offers keying and polarization features built into the housings that eliminate mismatching and crossed wires. Two through eight circuit housings facilitate improved assembly

operations and the Positive Lock terminal provides excellent retention of the connector.

The acronym RAST 5 in the title is a reference to the European design standard for appliance wiring and component design, "Raster Anschluss Steck Technik 5 mm". This standard outlines a system of keying, polarization and latching that is popular in Europe and other parts of the world. The Positive Lock RAST 5 system has been designed to mate with many of the components built with a RAST 5 standard interface. This system is an excellent way for OEMs or their

subcontractors to use existing lead makers and termination equipment to produce connectors that mate to controls with RAST interfaces.

While the origins of this product are in the appliance industry, many other industries are embracing this style of connector. Marine, exercise equipment and hand tool manufacturers are recent examples of customers beginning to use this system. Any application where .250 x .032 [6.35 x 0.81] tabs are built on 5 mm centerlines is a potential candidate for this popular connector system.

5

Positive Lock RAST 5 Connector System

Positive Lock RAST 5 Connector System (Continued)

**Positive Lock RAST 5 Mark III
250 Series Receptacles**
Stock Thickness— .013 [0.33]
Tab size— .032 [0.81]

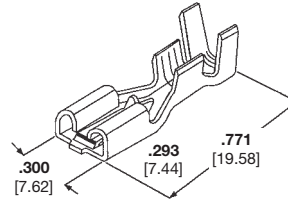

Wire Range AWG	ID	Material and Finish	Part Number			Applicator No.
22-18	.060-.110 1.52-2.79	Brass	1217378-1	X	X	1852165-2
		Tin Plated Brass	1217378-2	X	X	1852165-2
18-14 (2) 18	.090-.155 2.29-3.94 .190 4.83 Max.	Brass	1217094-1	X	X	680653-2
		Tin Plated Brass	1217094-2	X	X	680653-2
16-12 (2) 18 (2) 16	.120-.170 3.04-4.32 (2) .120 3.05 Max. (2) .120 3.05 Max.	Brass	1217095-1	X	X	680654-2
		Tin Plated Brass	1217095-2	X	X	680654-2

Receptacle Housings
Material— 94 V-0, 6/6 Nylon

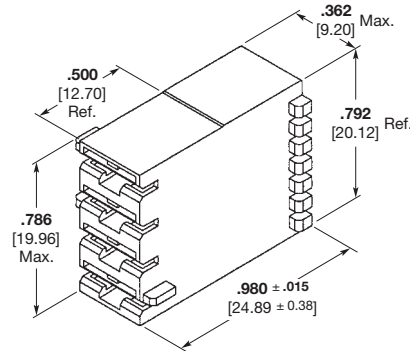

Standard Version

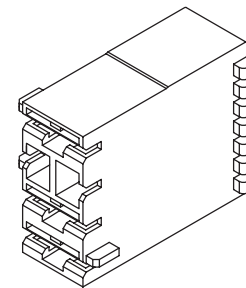

Blocked Circuit Version

Description			Part Number	
			Standard Version ⁴	Blocked Circuit Version ⁵
2 Position	X	X	521204	—
3 Position	X	X	521205	521782
4 Position	X	X	521206	521295
5 Position	X	X	521207	521267
6 Position	X	X	521208	521435
7 Position	X	X	521209	521935
8 Position	X	X	521210	—
9 Position	X	X	521746	521936
10 Position	X	X	521792	521836
11 Position	X	X	521699	1969335

Notes: 1. All part numbers are RoHS compliant.
2. Housing base part number provided.
3. Standard colors are natural and blue.
4. Keying patterns determined by part dash number. Refer to the customer drawing for pattern options.
5. Blocking patterns determined by part dash number. Refer to the customer drawing for pattern options.

Note: All part numbers are RoHS compliant.

Introduction

PCB Connector that Meets RAST 5 Standard

PCB connector that meets RAST 5 standard with vertical through hole technology, available with tin or silver plating, external locking.

Key Features

- 1 Designed to the RAST 5 Standard
- 2 Tin / Silver plating
- 3 2-8 positions
- 4 Available in multiple colors
- 5 3 footprint layouts
- 6 Thousands of configurations of keying & latching & polarization
- 7 UL/VDE/CQC approval
- 8 Meets UL 94 V0 & GWT 750°C w/o flame

Applications

- 1 Front-loading washing machine
- 2 Dishwasher
- 3 Microwave oven
- 4 Refrigerator

Electrical

- 1 Rated Current: 16 A for Tin plated version; 20 A for Silver plated version
- 2 Rated Voltage: 250 V AC
- 3 Insulation Resistance: 5000 MΩ
- 4 Dielectric Strength: 3000 V

Materials

- 1 Housing: Meets Thermoplastic UL 94 V0 and IEC 60335-1
- 2 Contact: Copper Alloy, Tin or Silver plating over Nickel

Standards And Specifications

- 1 According to RAST 5 Specification
- 2 Product Specification: 108-106080
108-2183

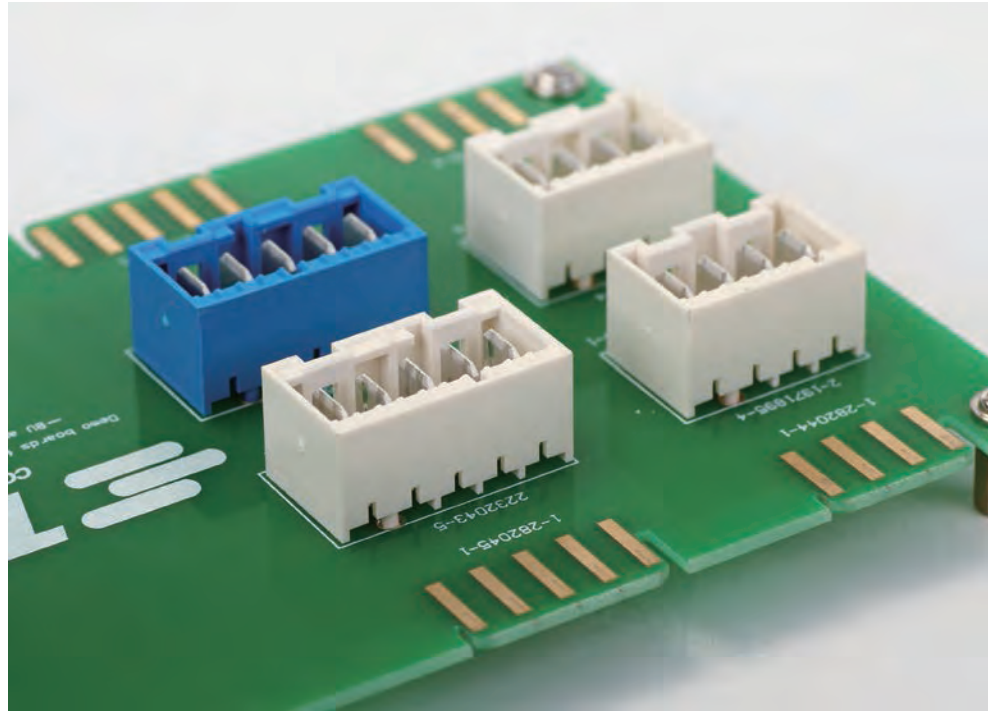

TE's PCB connectors that meets RAST standard come with a broad range of options and comply with most industrial and appliances safety standards, including UL94-V0, IEC 60335-1 (GWT 750°C), as well as certificates of conformity by UL, VDE and CQC.

These product additions offer a more optimized product portfolio

and more flexible solutions, and are particularly ideal for wire-to-board connections and control-units of major appliances and other applications.

Both models also offer choices of tin or silver plating, several different colors and various configurations of keying for customization needs to save cost.

The 5mm-pitch PCB connectors that meet RAST 5 standard come with two to eight positions and three footprint layouts.

DIN Style, Vertical

Position	Part Number	Tab Contact Plating	Keying And Locking Latch	Color	Pcb Lay Out
General	#-1971845-#	Tin		Natural Color (See Table 1)	
	#-1971846-#	Silver			
	#-1971895-#	Tin			
	#-1971896-#	Silver			
2	#-1971845-2	Tin	 1971845-2 1971895-2 1971846-2 1971896-2	Natural Color (See Table 1)	Even Number of Pins (See Fig 1)
	#-1971846-2	Silver			
	#-1971895-2	Tin			
	#-1971896-2	Silver			
3	#-1971845-3	Tin	 1971845-3 1971895-3 1971846-3 1971896-3	Natural Color (See Table 1)	Odd Number of Pins (See Fig 1)
	#-1971846-3	Silver			
	#-1971895-3	Tin			
	#-1971896-3	Silver			
4	#-1971845-4	Tin	 1971845-4 1971895-4 1971846-4 1971896-4	Natural Color (See Table 1)	Even Number of Pins (See Fig 1)
	#-1971846-4	Silver			
	#-1971895-4	Tin			
	#-1971896-4	Silver			
5	#-1971845-5	Tin	 1971845-5 1971895-5 1971846-5 1971896-5	Natural Color (See Table 1)	Odd Number of Pins (See Fig 1)
	#-1971846-5	Silver			
	#-1971895-5	Tin			
	#-1971896-5	Silver			
6	#-1971845-6	Tin	 1971845-6 1971895-6 1971846-6 1971896-6	Natural Color (See Table 1)	Even Number of Pins (See Fig 1)
	#-1971846-6	Silver			
	#-1971895-6	Tin			
	#-1971896-6	Silver			

DIN Style, Vertical

Position	Part Number	Tab Contact Plating	Keying And Locking Latch	Color	Pcb Lay Out
7	#-1971845-7	Tin		Natural Color (See Table 1)	Odd Number of Pins (See Fig 1)
	#-1971846-7	Silver			
	#-1971895-7	Tin			
	#-1971896-7	Silver			
8	#-1971845-8	Tin		Natural Color (See Table 1)	Even Number of Pins (See Fig 1)
	#-1971846-8	Silver			
	-	-			
	-	-			

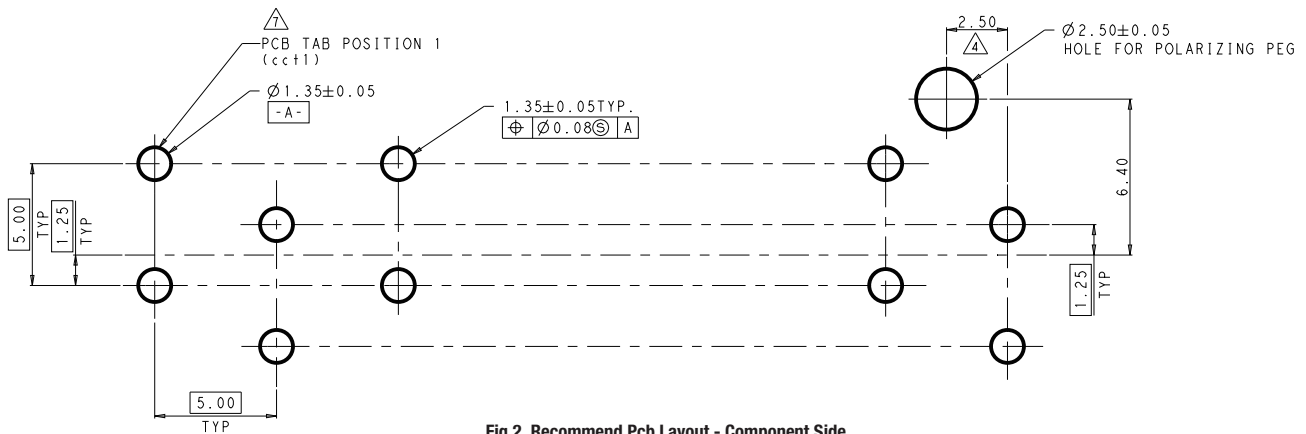

Fig 2. Recommend Pcb Layout - Component Side
Pcb 1.5±0.2 Thick

DIN Style, Vertical

TABLE 1

Color	With Tin Plating Contact		With Silver Plating Contact		COMMENTS
Natural	#-1971845-#	#-1971895-#	#-1971846-#	#-1971896-#	
Red	#-1971946-#	#-1971948-#	#-1971947-#	#-1971949-#	
Blue	#-1971954-#	#-1971956-#	#-1971955-#	#-1971957-#	
Yellow	#-2232008-#	#-2232010-#	#-2232009-#	#-2232011-#	
Black	#-2232000-#	#-2232002-#	#-2232001-#	#-2232003-#	
Grey	#-2232016-#	#-2232018-#	#-2232017-#	#-2232019-#	
Green	#-1971962-#	#-1971964-#	#-1971963-#	#-1971965-#	
Purple	#-2232024-#	#-2232026-#	#-2232025-#	#-2232027-#	
White	#-2232289-#	#-2232291-#	#-2232290-#	#-2232292-#	

The Prefix And Postfix Are The Same With The P/N Of The Natural Tab Header For The Same Keying , Polarization, Latch Window Configuration. Just The Base Numbers Are Different Based On Different Color. * And # Can Be The Number From 0 To 9.
Silver

For Any Keying Configuration, There Are Eight Colors Available, Besides The Natural Color, There Are Other Seven Colors, Include: Yellow, Blue, Grey, Purple, Red, Green, Black. The P/n of The Color Tab Header Are Based On The Natural Tab Header, The Prefix And Postfix Are The Same For The Same Keying Configuration, But The Base Numbers Are Different According To Different Color. the Following Shows What's The P/n For Color Tab Header. The Related P/n of The Housing For The Color Tab Header Are Also Based On The Natural Housing, Only The Base Number Is Different.

DIN Style, Vertical, Opposite

Position	Part Number	Tab Contact Plating	Keying And Locking Latch		Color	Pcb Lay Out
General	#-2232043-#	Tin			Natural Color (See Table 2)	
	#-2232044-#	Silver				
	#-2232045-#	Tin				
	#-2232046-#	Silver				
2	#-2232043-2	Tin			Natural Color (See Table 2)	(See Fig 2)
	#-2232044-2	Silver				
	#-2232045-2	Tin				
	#-2232046-2	Silver				
3	#-2232043-3	Tin			Natural Color (See Table 2)	(See Fig 2)
	#-2232044-3	Silver				
	#-2232045-3	Tin				
	#-2232046-3	Silver				
4	#-2232043-4	Tin			Natural Color (See Table 2)	(See Fig 2)
	#-2232044-4	Silver				
	#-2232045-4	Tin				
	#-2232046-4	Silver				
5	#-2232043-5	Tin			Natural Color (See Table 2)	(See Fig 2)
	#-2232044-5	Silver				
	-	Tin				
	-	Silver				
6	#-2232043-6	Tin			Natural Color (See Table 2)	(See Fig 2)
	#-2232044-6	Silver				
	#-2232045-6	Tin				
	#-2232046-6	Silver				

DIN Style, Vertical, Opposite

Position	Part Number	Tab Contact Plating	Keying And Locking Latch	Color	Pcb Lay Out
7	#-2232043-7	Tin		Natural Color (See Table 2)	(See Fig 2)
	#-2232044-7	Silver			
	-	-			
	-	-			
8	#-2232043-8	Tin		Natural Color (See Table 2)	(See Fig 2)
	#-2232044-8	Silver			
	-	-			
	-	-			

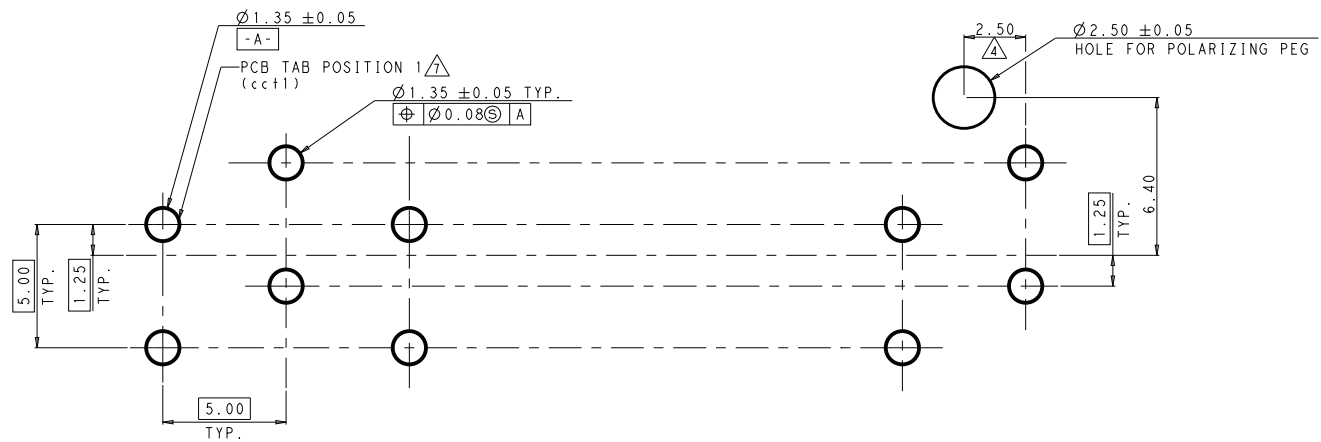

Fig 2. Recommend Pcb Layout - Component Side
Pcb 1.5±0.2 Thick

DIN Style, Vertical, Opposite

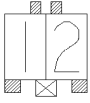
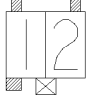
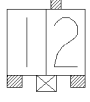
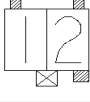
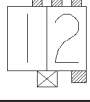
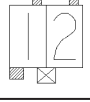
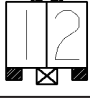
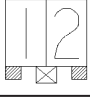
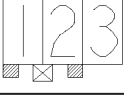

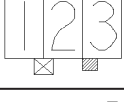

Table 2

Color	With Tin Plating Contact		With Silver Plating Contact		Comments
Natural	#-2232043-#	#-2232045-#	#-2232044-#	#-2232046-#	
Red	#-2232055-#	#-2232057-#	#-2232056-#	#-2232058-#	
Blue	#-2232047-#	#-2232049-#	#-2232048-#	#-2232050-#	
Yellow	#-2232063-#	#-2232065-#	#-2232064-#	#-2232066-#	
Black	#-2232059-#	#-2232061-#	#-2232060-#	#-2232062-#	
Grey	#-2232067-#	#-2232069-#	#-2232068-#	#-2232070-#	
Green	#-2232051-#	#-2232053-#	#-2232052-#	#-2232054-#	
Purple	#-2232071-#	#-2232073-#	#-2232072-#	#-2232074-#	
White	#-2232298-#	#-2232300-#	#-2232299-#	#-2232301-#	

"The Prefix And Postfix Are The Same With The P/N Of The Natural Tab Header For The Same Keying , Polarization, Latch Window Configuration. Just The Base Numbers Are Different Based On Different Color. * And # Can Be The Number From 0 To 9."

For Any Keying Configuration, There Are Eight Colors Available, Besides The Natural Color, There Are Other Seven Colors, Include: Yellow, Blue, Grey, Purple, Red, Green, Black. The P/n of The Color Tab Header Are Based On The Natural Tab Header, The Prefix And Postfix Are The Same For The Same Keying Configuration, But The Base Numbers Are Different According To Different Color. the Following Shows What's The P/n For Color Tab Header. The Related P/n of The Housing For The Color Tab Header Are Also Based On The Natural Housing, Only The Base Number Is Different.





Positive Lock Style, Vertical

Pos	Part Number	Coding	Vertical
2	521382-2		Vertical
2	1-521382-2		Vertical
2	2-521382-2		Vertical
2	3-521382-2		Vertical
2	4-521382-2		Vertical
2	5-521382-2		Vertical
2	6-521382-2		Vertical
2	2-521384-2		Vertical
3	521382-3		Vertical
3	1-521382-3		Vertical
3	2-521382-3		Vertical
3	3-521382-3		Vertical

Positive Lock Style, Vertical

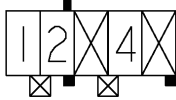
Pos	Part Number	Coding	Vertical
3	4-521382-3		Vertical
3	5-521382-3		Vertical
3	521388-3		Vertical
4	521382-4		Vertical
4	1-521382-4		Vertical
4	2-521382-4		Vertical
4	3-521382-4		Vertical
4	4-521382-4		Vertical
4	5-521382-4		Vertical
4	521388-4		Vertical
4	1-521388-4		Vertical
5	521382-5		Vertical

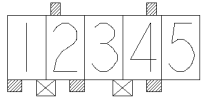
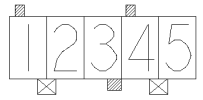
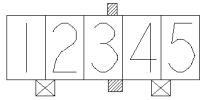
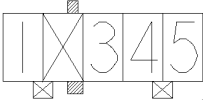
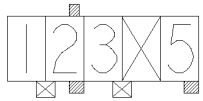
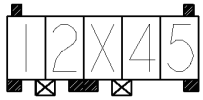
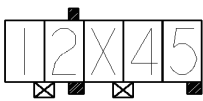
Positive Lock Style, Vertical

Pos	Part Number	Coding	Vertical
5	1-521382-5		Vertical
5	2-521382-5		Vertical
5	3-521382-5		Vertical
5	4-521382-5		Vertical
5	5-521382-5		Vertical
5	6-521382-5		Vertical
5	7-521382-5		Vertical
5	8-521382-5		Vertical
5	521388-5		Vertical
5	1-521388-5		Vertical
6	521382-6		Vertical
6	1-521382-6		Vertical

Positive Lock Style, Vertical

Pos	Part Number	Coding	Vertical
6	1-521382-6		Vertical
6	2-521382-6		Vertical
7	521382-7		Vertical
7	1-521382-7		Vertical
7	2-521382-7		Vertical
7	3-521382-7		Vertical
7	521388-7		Vertical
7	1-521388-7		Vertical
8	521382-8		Vertical
8	1-521382-8		Vertical
8	2-521382-8		Vertical
8	3-521382-8		Vertical
8	521388-8		Vertical

6
RAST 5 Tab Header

RAST5 Positive Lock Tab Header (GWT)

Position	Part Number	Tab Contact Plating	Keying And Locking Latch	Color	Pcb Lay Out
General	#-2232532-#	Tin	-	Natural Color (See Table 1)	
	#-2232559-#	Silver			
2	#-2232532-2	Tin	 2232532-2 2232559-2	Natural Color (See Table 1)	Even Number of Pins (See Fig 1)
	#-2232559-2	Silver			
3	#-2232532-3	Tin	 2232532-3 2232559-3	Natural Color (See Table 1)	Odd Number of Pins (See Fig 1)
	#-2232559-3	Silver			
4	#-2232532-4	Tin	 2232532-4 2232559-4	Natural Color (See Table 1)	Even Number of Pins (See Fig 1)
	#-2232559-4	Silver			
5	#-2232532-5	Tin	 2232532-5 2232559-5	Natural Color (See Table 1)	Odd Number of Pins (See Fig 1)
	#-2232559-5	Silver			
6	#-2232532-6	Tin	 2232532-6 2232559-6	Natural Color (See Table 1)	Even Number of Pins (See Fig 1)
	#-2232559-6	Silver			
7	#-2232532-7	Tin	 2232532-7 2232559-7	Natural Color (See Table 1)	Odd Number of Pins (See Fig 1)
	#-2232559-7	Silver			
8	#-2232532-8	Tin	 2232532-8 2232559-8	Natural Color (See Table 1)	Even Number of Pins (See Fig 1)
	#-2232559-8	Silver			

RAST5 Positive Lock Tab Header (GWT)

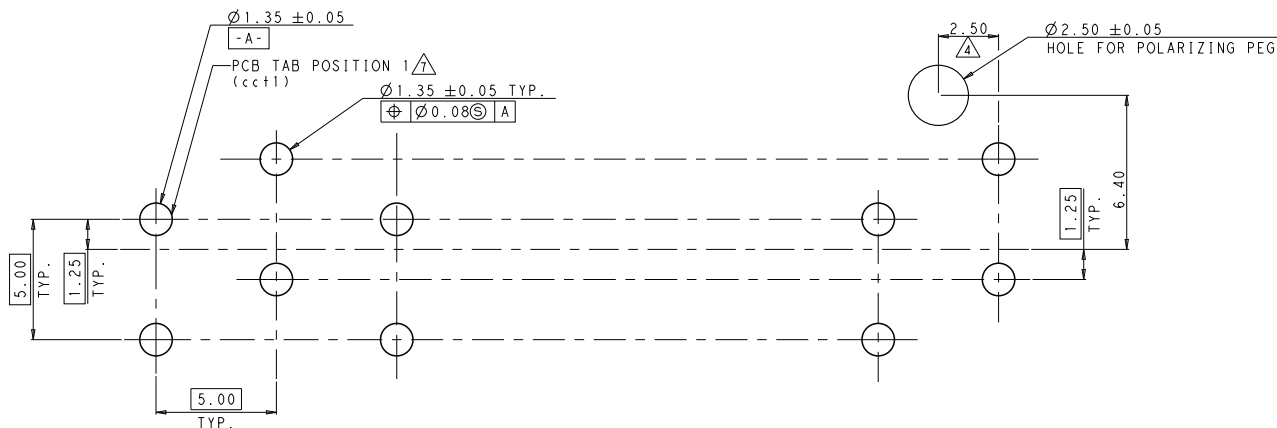

Fig 1. Recommend Pcb Layout - Solder Side
Pcb 1.5±0.2 Thick

TABLE 1

Color	With Tin Plating Contact		With Silver Plating Contact		Comments
Natural	#-2232532-#	#-2232557-#	#-2232559-#	#-2232560-#	The details of configuration see sheet 5 & 6.
Red	#-2232562-#	#-2232563-#	#-2232565-#	#-2232566-#	If the prefix and postfix numbers of different color header are same as the ones of the natural tab header and they are in same column, so they should have the same configuration: same keying, polarization and latch window.
Blue	#-2232568-#	#-2232569-#	#-2232571-#	#-2232572-#	
Yellow	#-2232574-#	#-2232575-#	#-2232577-#	#-2232578-#	
Black	#-2232580-#	#-2232581-#	#-2232583-#	#-2232584-#	For different base number of same color header, only difference is configuration (keying, polarization and latch 0to9. Window).
Grey	#-2232586-#	#-2232587-#	#-2232589-#	#-2232590-#	The related housing part numbers of different color tab header are also based on natural housing, only the base number is different, the details see bom in sheet 2, 3 & 4.
Green	#-2232592-#	#-2232593-#	#-2232595-#	#-2232596-#	
Purple	#-2232598-#	#-2232599-#	#-2232601-#	#-2232602-#	
White	#-2232604-#	#-2232605-#	#-2232607-#	#-2232608-#	The "*" and "#" can be the number from 0 to 9.

- Notes:
1. For tab header color choice, there are eight colors available, besides the natural color, there are other seven colors, include: yellow, blue, grey, purple, red, green, black. The p/n of the color tab header are based on the natural tab header, the prefix and postfix are the same.
 2. More information see comments in right column of below chart.

RAST5 Positive Lock Tab Header, Opposite (GWT)

Position	Part Number	Tab Contact Plating	Keying And Locking Latch	Color	Pcb Lay Out
General	#-2232647-#	Tin	-	Natural Color (See Table 2)	
	#-2232649-#	Silver			
2	#-2232647-2	Tin		Natural Color (See Table 2)	(See Fig 2)
	#-2232649-2	Silver	2232647-2 2232649-2		
3	#-2232647-3	Tin		Natural Color (See Table 2)	(See Fig 2)
	#-2232649-3	Silver	2232647-3 2232649-3		
4	#-2232647-4	Tin		Natural Color (See Table 2)	(See Fig 2)
	#-2232649-4	Silver	2232647-4 2232649-4		
5	#-2232647-5	Tin		Natural Color (See Table 2)	(See Fig 2)
	#-2232649-5	Silver	2232647-5 2232649-5		
6	#-2232647-6	Tin		Natural Color (See Table 2)	(See Fig 2)
	#-2232649-6	Silver	2232647-6 2232649-6		
7	#-2232647-7	Tin		Natural Color (See Table 2)	(See Fig 2)
	#-2232649-7	Silver	2232647-7 2232649-7		
8	#-2232647-8	Tin		Natural Color (See Table 2)	(See Fig 2)
	#-2232649-8	Silver	2232647-8 2232649-8		

RAST5 Positive Lock Tab Header, Opposite (GWT)

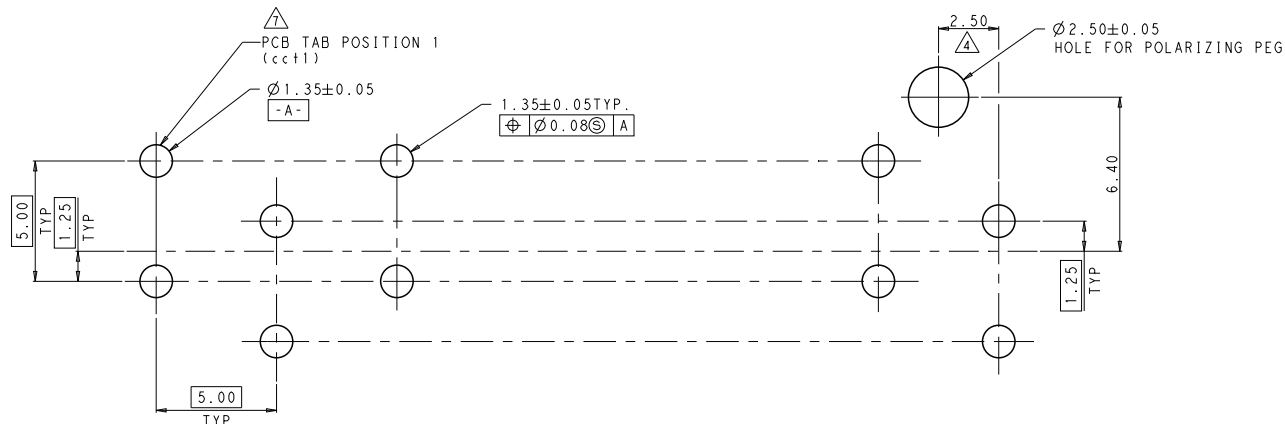

Fig 2. Recommend Pcb Layout - Solder Side
Pcb 1.5±0.2 Thick

TABLE 2

Color	With Tin Plating Contact		With Silver Plating Contact		Comments
Natural	#-2232647-#	#-2232648-#	#-2232649-#	#-2232650-#	The details of configuration see sheet 6.
Red	#-2232651-#	#-2232652-#	#-2232653-#	#-2232654-#	If the prefix and postfix numbers of different color header are same as the ones of the natural tab header and they are in same column, so they should have the same configuration: same keying, polarization and latch window.
Blue	#-2232655-#	#-2232656-#	#-2232657-#	#-2232658-#	
Yellow	#-2232659-#	#-2232660-#	#-2232661-#	#-2232662-#	
Black	#-2232663-#	#-2232664-#	#-2232665-#	#-2232666-#	For different base number of same color header, only difference is configuration (keying, polarization and latch 0to9. Window).
Grey	#-2232667-#	#-2232668-#	#-2232669-#	#-2232670-#	The related housing part numbers of different color tab header are also based on natural housing, only the base number is different, the details see bom in sheet 2, 3 & 4.
Green	#-2232671-#	#-2232672-#	#-2232673-#	#-2232674-#	
Purple	#-2232675-#	#-2232676-#	#-2232677-#	#-2232678-#	
White	#-2232679-#	#-2232680-#	#-2232681-#	#-2232682-#	The "*" and "#" can be the number from 0 to 9.

- Notes: 1. For tab header color choice, there are eight colors available, besides the natural color, there are other seven colors, include: yellow, blue, grey, purple, red, green, black. The p/n of the color tab header are based on the natural tab header, the prefix and postfix are the same.
2. More information see comments in right column of below chart.

Positive Lock connector Style

Pos	Part Number	Coding	Right Angle
2	521384-2		Right Angle
2	1-521384-2		Right Angle
2	3-521384-2		Right Angle
2	4-521384-2		Right Angle
2	5-521384-2		Right Angle
2	6-521384-2		Right Angle
2	521388-2		Right Angle
2	521385-2		Right Angle
2	1-521385-2		Right Angle
2	2-521385-2		Right Angle
2	3-521385-2		Right Angle
2	4-521385-2		Right Angle

Positive Lock connector Style

Pos	Part Number	Coding	Right Angle
2	5-521385-2		Right Angle
2	5-1969352-2		Right Angle
2	6-521385-2		Right Angle
2	3-521755-2		Right Angle
2	5-1969234-2		Right Angle
2	1969352-2		Right Angle
3	521384-3		Right Angle
3	1-521384-3		Right Angle
3	2-521384-3		Right Angle
3	3-521384-3		Right Angle
3	4-521384-3		Right Angle
3	521385-3		Right Angle

Positive Lock connector Style

Pos	Part Number	Coding	Right Angle
3	1-521385-3		Right Angle
3	2-521385-3		Right Angle
3	3-521385-3		Right Angle
3	521386-3		Right Angle
4	521385-4		Right Angle
4	1-521385-4		Right Angle
4	2-521385-4		Right Angle
4	3-521385-4		Right Angle
4	6-521778-4		Right Angle
4	4-521385-4		Right Angle
4	5-521385-4		Right Angle
4	6-521385-4		Right Angle

Positive Lock connector Style

Pos	Part Number	Coding	Right Angle
4	521384-4		Right Angle
4	1-521384-4		Right Angle
4	2-521384-4		Right Angle
4	3-521384-4		Right Angle
4	4-521384-4		Right Angle
4	5-521384-4		Right Angle
4	521386-4		Right Angle
4	521778-4		Right Angle
5	521384-5		Right Angle
5	1-521384-5		Right Angle
5	2-521384-5		Right Angle
5	3-521384-5		Right Angle

Positive Lock connector Style

Pos	Part Number	Coding	Right Angle
5	521385-5		Right Angle
5	1-521385-5		Right Angle
5	2-521385-5		Right Angle
5	3-521385-5		Right Angle
5	4-521385-5		Right Angle
5	521386-5		Right Angle
5	2-1969352-5		Right Angle
6	521384-6		Right Angle
6	1-521384-6		Right Angle
6	521385-6		Right Angle
6	1-521385-6		Right Angle
6	2-521385-6		Right Angle

Positive Lock connector Style

Pos	Part Number	Coding	Right Angle
6	521778-6		Right Angle
7	521384-7		Right Angle
7	1-521384-7		Right Angle
7	2-521384-7		Right Angle
7	3-521384-7		Right Angle
7	521385-7		Right Angle
7	1-521385-7		Right Angle
7	2-521385-7		Right Angle
7	3-521385-7		Right Angle
7	1955660-7		Right Angle
8	521384-8		Right Angle
8	1-521384-8		Right Angle

Introduction

AMP DUOPLUG 2.5 Connector System for Wire-to-Board Applications

The AMP DUOPLUG 2.5 connector system offers a complete printed circuit board system which is suitable for edge as well as female to header applications using the same female part.

The top of the female contact is provided with an IDC slot, a technique which permits high speed wire termination.

Application tooling specially developed for this system can produce cable assemblies with connectors at one or both ends.

The connector keying is produced with a cutting unit on the application tooling machine.

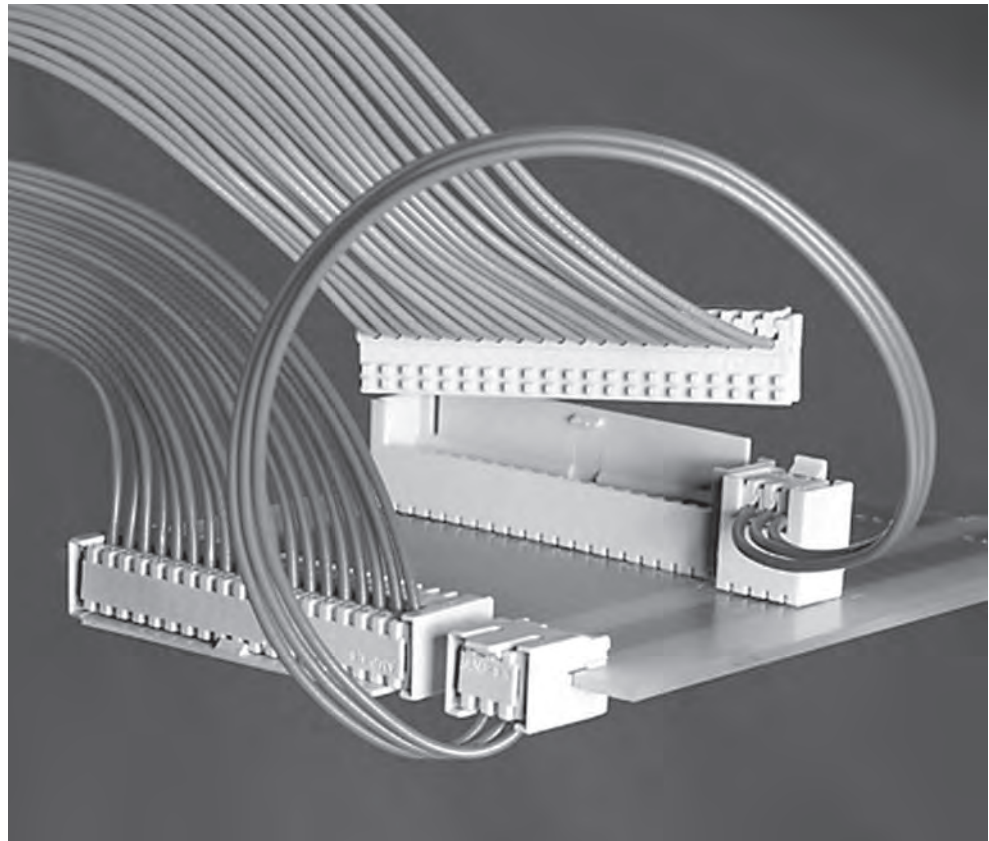

Applications

- Household Appliances
- Consumer Electronics
- Telecommunication Industry
- Automotive Industry
- Vending Machines
- Measuring Devices and others
- Specific Silicone-IDC wires are applicable

Technical Data

No. of Positions:
3- to 20-positions
3- to 12-positions

Centerline:
2.5 mm

Termination Technique:
Insulation Displacement
Technique

Housing Material:
PBT-GF, PA 6.6 GF

Contact Material:
CuSn (CuZn)
Phosphor Bronze (Brass)

Contact Finish:
Female pre-tinned

PC Board Thickness:
1.5 mm

Wire Range (DGB I):
0.22 mm², 7 stranded
0.35 mm², 12 stranded

Wire Range (DGB II):
0.35 mm², 7 stranded

Temperature Range:
-40 °C up to +110 °C

Current Voltage:
63 V (250 V)

Current Rating:
max. 2 A

Insulation Diameter:
1.2-1.4 mm

Contact Resistance:
≤10 mΩ

Insulation Hardness:
Shore A 92±3

Flammability Rating:
acc. UL 94 V-0

Product Specification:
108-18056 / 108-20238

Application Specification:
114-18049

Technical Features

Product Features

- Connector system for rationalised production
- High production rate with no rejects
- One-piece and two-piece connector system
- Keyable female part
- Contacts protected against damage
- Controllable wire insertion
- Wire strain relief provided by cover
- Defined wire insertion **depth**
- Customer specific version of header
- Protection provided by three side walls
- Designed according to RAST 2.5 specification
- VDE Tested acc. to:
DIN VDE 40021724 and
DIN EN 60998, Part 2-3

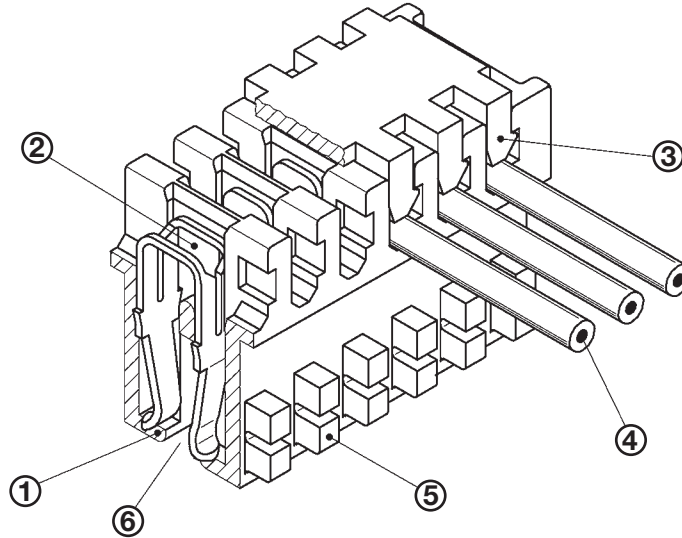

- | | | |
|--|--|---|
| <p>1 Very good contact protection in order to avoid any stubbing problems.</p> <p>2 Termination of the wire via metal stuffer of the tooling which guarantees a defined position of the wire in the IDC-slot of the contact.</p> | <p>3 Reliable locking feature of every single contact assures proper strain relief.</p> <p>4 Contact suitable for 7- and 12-stranded wire.</p> <p>5 Cutting of the keying in accordance to customer's demand during the termination process.</p> | <p>6 Connector design suitable for one-piece as well as for two-piece connection.</p> |
|--|--|---|

Indirect and Direct Connection, 2.5 mm Centerline

Direct Connection

- 1 Cover
- 2 Wire
- 3 Connector front side
- 4 Keying
- 5 PC board frame
- 6 Keying
- 7 PC board 1.5mm thick

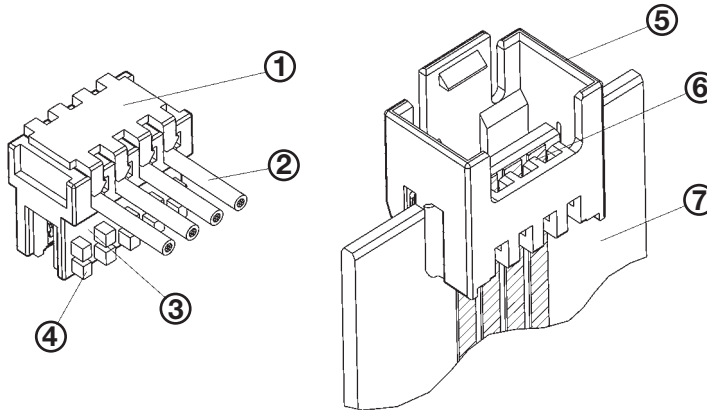

**Indirect Connection,
2.5 mm Centerline**

- 1 Cover
- 2 Wire
- 3 Connector front side
- 4 Keying
- 5 Tab header
- 6 Tab contact
(1.5mm x 0.6mm)
- 7 Keying
- 8 PC board 1.5mm thick

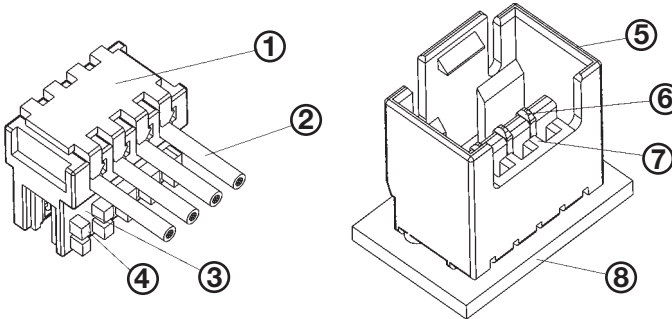

Technical Data

No. of Positions:

3- to 20-positions

Centerline:

2.5 mm
(selective loading possible)

Termination Technique:

Insulation Displacement
Technique

Wire Size Range:

IDC Contact DGB I:
0.22-0.25 mm², 7 strands
0.32-0.35 mm², 12 strands
Solid wire 0.40-0.50mm
diameter

IDC Contact DGB II:

0.32-0.35 mm², 7 strands

Insulation Diameter:

Nominal size 1.3 mm

Insulation Hardness:

Shore A 92±3

Contact Material:

Phosphor Bronze (Brass)

Contact Finish:

Female pre-tinned
Male post-tinned

Housing Material:

PBT-GF, PA 6.6 GF

Flammability Rating:

UL 94 V-0

VDE Tested acc. to:

DIN VDE 0627/9.91 and
DIN EN 60998, Part 2-3

Keying:

Variable, because there is a row
of keying ribs on the front side
of the connector. Ribs removed
during application according to
requirements.

Current Carrying Capacity:

max. 2 A

Contact Resistance:

≤10 mΩ

Nominal Voltage:

Fully loaded, 63 V
Selectively loaded, 250 V

Temperature Range:

-40 °C up to +110 °C

Product Specification:

108-18056

Application Specification:

114-18049

Packaging Specification:

107-18026

AMP DUOPLUG 2.5 Female Connectors Fully Loaded

Pos.	Part Number	DGB I(0.22-0.35)/ DGB II	Color Code	UL 94 V0+GWT 750°C (No Flame)	Side locking	PCB Locking
3	293132-3	DGB I	Orange	-	-	-
3	1-1355006-3	DGB II	Natural	-	-	-
3	284930-3	DGB I	Natural	-	-	-
3	2-284930-3	DGB I	Green	-	-	-
3	3-284932-3	DGB I	Red	-	-	-
3	2-284865-3	DGB I	Red	-	✓	-
3	284865-3	DGB I	Black	-	✓	-
3	284932-3	DGB I	Black	-	-	-
3	1-293207-3	DGB I	Green	✓	-	-
3	2-284932-3	DGB I	Green	-	-	-
3	1-966930-3	DGB II	Natural	-	-	-
3	1-1355181-3	DGB II	Natural	-	-	✓
4	1-1241121-4	DGB I	Natural	-	-	-
4	1-1355006-4	DGB II	Natural	-	-	-
4	1-1355181-4	DGB II	Natural	-	-	✓
4	1-966194-4	DGB II	Natural	-	-	-
4	1-969928-4	DGB I	Natural	-	-	-
4	2-284930-4	DGB I	Red Mark	-	-	-
4	2-284932-4	DGB I	Black	-	-	-
4	284865-4	DGB I	Black	-	✓	-
4	284930-4	DGB I	Natural	-	-	-
4	284932-4	DGB I	Brown	-	-	-
4	3-284865-4	DGB I	Red	-	✓	-
4	3-829868-4	DGB I	Natural	-	-	-
5	1-1355006-5	DGB II	Natural	-	-	-
5	1-1355181-5	DGB II	Natural	-	-	✓
5	1-966194-5	DGB II	Natural	-	-	-
5	2-284865-5	DGB I	Red	-	✓	-
5	2-284932-5	DGB I	Green	-	-	-

AMP DUOPLUG 2.5 Female Connectors Fully Loaded

Pos.	Part Number	DGB I	Color Code	UL 94 V0+GWT 750°C (No Flame)	Side locking
6	2-284865-6	0.22-0.35	Red	-	√
6	284930-6	0.22-0.35	Natural	-	-
6	2-284930-6	0.22-0.35	Blue	-	-
6	284932-6	0.22-0.35	Red	-	-
6	1-284932-6	0.22-0.35	Blue	-	-
6	2-284932-6	0.22-0.35	Black	-	-
6	1-1241121-6	0.22-0.35	Natural	-	-
6	3-1987611-6	0.22-0.35	Natural	-	-
7	284865-7	0.22-0.35	Black	-	√
7	284930-7	0.22-0.35	Natural	-	-
7	284932-7	0.22-0.35	Red	-	-
8	284865-8	0.22-0.35	Black	-	√
8	2-284865-8	0.22-0.35	Red	-	√
8	284930-8	0.22-0.35	Natural	-	-
8	284932-8	0.22-0.35	Black	-	-
8	2-284932-8	0.22-0.35	Brown	-	-
8	3-829868-8	0.22-0.35	Natural	-	-
9	284865-9	0.22-0.35	Black	-	√
9	284932-9	0.22-0.35	Black	-	-
9	3-829868-9	0.22-0.35	Natural	-	-
10	1-284865-0	0.22-0.35	Black	-	√
10	2-284865-0	0.22-0.35	Red	-	√
10	1-284932-0	0.22-0.35	Black	-	-
11	1-284930-1	0.22-0.35	Natural	-	-
11	1-284932-1	0.22-0.35	Black	-	-
12	1-284865-2	0.22-0.35	Black	-	√
12	2-284865-2	0.22-0.35	Red	-	√
13	4-284932-3	0.22-0.35	Black	-	-
13	3-829869-3	0.22-0.35	Natural	-	-

AMP DUOPLUG 2.5 Female Connectors Fully Loaded

Pos.	Part Number	DGB I(0.22-0.35)/ DGB II	Color Code	UL 94 V0+GWT 750°C (No Flame)	Side locking	PCB Locking
8	284865-8	DGB I	Black	-	✓	-
8	284930-8	DGB I	Natural	-	-	-
8	284932-8	DGB I	Black	-	-	-
8	3-829868-8	DGB I	Natural	-	-	-
9	1-1355006-9	DGB II	Natural	-	-	-
9	1-1355181-9	DGB II	Natural	-	-	✓
9	1-966194-9	DGB II	Natural	-	-	-
9	284865-9	DGB I	Black	-	✓	-
9	284932-9	DGB I	Black	-	-	-
9	3-829868-9	DGB I	Natural	-	-	-
10	1-1355006-0	DGB II	Natural	-	-	-
10	1-1355181-0	DGB II	Natural	-	-	✓
10	1-284865-0	DGB I	Black	-	✓	-
10	1-284932-0	DGB I	Black	-	-	-
10	1-966194-0	DGB II	Natural	-	-	-
10	2-284865-0	DGB I	Red	-	✓	-
11	1-284930-1	DGB I	Natural	-	-	-
11	1-284932-1	DGB I	Black	-	-	-
11	1-966195-1	DGB II	Natural	-	-	-
12	1-1355182-2	DGB II	Natural	-	-	✓
12	1-284865-2	DGB I	Black	-	✓	-
12	1-966195-2	DGB II	Natural	-	-	-
12	2-284865-2	DGB I	Red	-	✓	-
13	3-829869-3	DGB I	Natural	-	-	-
13	4-284932-3	DGB I	Black	-	-	-
14	3-829869-4	DGB I	Natural	-	-	-
15	1-966195-5	DGB II	Natural	-	-	-
16	1-966195-6	DGB II	Natural	-	-	-
16	3-829869-6	DGB I	Natural	-	-	-

AMP DUOPLUG 2.5 Female Connectors Fully Loaded

Pos.	Part Number	DGB I(0.22-0.35)/ DGB II	Color Code	UL 94 V0+GWT 750°C (No Flame)	Side locking	PCB Locking
18	1-966195-8	DGB II	Natural	-	-	-
18	3-829869-8	DGB I	Natural	-	-	-
19	1-966195-9	DGB II	Natural	-	-	-
19	3-829869-9	DGB I	Natural	-	-	-
20	3-829869-0	DGB I	Natural	-	-	-

AMP DUOPLUG 2.5 Female Connectors Selectively Loaded

Pos.	Part Number	DGB I (0.22-0.35)/ DGB II	SL: Cavities Loaded	Color Code	UL 94 V0+GWT 750°C (No Flame)	Side locking	PCB Locking
3	284931-3	DGB I	1/3	Blue	-	-	-
3	2-284931-3	DGB I	1/3	Natural	-	-	-
3	3-284931-3	DGB I	1/3	Green	-	-	-
3	4-284931-3	DGB I	1/3	Brown	-	-	-
3	284866-3	DGB I	1/3	Blue	-	✓	-
3	293207-3	DGB I	1/3	Orange	✓	-	-
3	1-284970-3	DGB I	1/3	Brown	-	-	-
3	2-284970-3	DGB I	1/3	Green	-	-	-
3	3-284970-3	DGB I	1/3	Blue	-	-	-
3	284970-3	DGB I	1/3	Natural	-	-	-
3	3-966480-3	DGB I	1/3	Natural	-	-	-
3	1-1241515-3	DGB I	1/3	Natural	-	-	-
3	1-1394427-3	DGB II	1/3	Natural	-	-	-
3	1-966842-3	DGB II	1/3	Natural	-	-	-
3	293153-3	DGB I	1/3	Black	-	-	-
3	2-284866-3	DGB I	1/3	Green	-	✓	-
4	2-284866-4	DGB I	1/2/4	Green	-	✓	-
4	293153-4	DGB I	3/4	Black	-	-	-
5	1-1394427-5	DGB II	1/3/5	Natural	-	-	-
5	2-284866-5	DGB I	1/3/4/5	Blue	-	✓	-
5	2-284931-5	DGB I	1/3/5	Natural	-	-	-
5	293249-5	DGB I	1/5	Blue	-	-	-
5	3-284866-5	DGB I	1/2/3/5	Green	-	✓	-
5	3-966480-5	DGB I	1/3/5	Natural	-	-	-
5	4-284931-5	DGB I	1/2/3/5	Green	-	-	-
5	284866-5	DGB I	2/4	Red	-	✓	-
5	293207-5	DGB I	1/3/5	Green	✓	-	-
5	3-284931-5	DGB I	1/5	Red	-	-	-
5	4-284866-5	DGB I	3/4/5	Orange	-	✓	-

AMP DUOPLUG 2.5 Female Connectors Selectively Loaded

Pos.	Part Number	DGB I (0.22-0.35)/ DGB II	SL: Cavities Loaded	Color Code	UL 94 V0+GWT 750°C (No Flame)	Side locking	PCB Locking
6	1-284931-6	DGB I	1/2/4/6	Blue	-	-	-
6	1-293153-6	DGB I	1/3/4/6	Red	-	-	-
6	284931-6	DGB I	1/3/4/6	Red	-	-	-
6	3-284932-6	DGB I	1/3/5/6	Green	-	-	-
6	3-966842-6	DGB II	1/3/4/6	Natural	-	-	-
6	2-284866-6	DGB I	1/2/4/6	Green	-	√	-
6	2-293153-6	DGB I	1/3/4/6	Black	-	-	-
6	284866-6	DGB I	1/3/5/6	Blue	-	√	-
6	293153-6	DGB I	1/2	Black	-	-	-
6	2-966480-6	DGB I	1/3/5/6	Natural	-	-	-
7	1-966842-7	DGB II	1/3/5/7	Natural	-	-	-
7	2-284931-7	DGB I	1/3/5/6/7	Green	-	-	-
7	284866-7	DGB I	1/3/5/6/7	Blue	-	√	-
7	284931-7	DGB I	1/3/5/7	Blue	-	-	-
7	293207-7	DGB I	1/3/5/7	Green	√	-	-
7	3-966480-7	DGB I	1/3/5/7	Natural	-	-	-
7	293153-7	DGB I	1/4/5/6/7	Black	-	-	-
8	2-284866-8	DGB I	1/3/4/5/6/7/8	Green	-	√	-
8	284866-8	DGB I	1/3/4/6/7/8	Blue	-	√	-
8	2-284931-8	DGB I	1/3/4/6/7/8	Green	-	-	-
8	284931-8	DGB I	1/2/3/5/6/8	Blue	-	-	-
8	3-284866-8	DGB I	1/3/5/6/7/8	Red	-	√	-
9	1-1394427-9	DGB II	1/3/5/7/9	Natural	-	-	-
9	1-966842-9	DGB II	1/3/5/7/9	Natural	-	-	-
9	2-284866-9	DGB I	1/3/4/5/6/7/8/9	Green	-	√	-
9	2-293207-9	DGB I	1/3/5/7/9	Green	√	-	-
9	284866-9	DGB I	1/3/4/6/7/9	Blue	-	√	-
9	293207-9	DGB I	1/3/4/6/8/9	Orange	√	-	-
9	3-966480-9	DGB I	1/3/5/7/9	Natural	-	-	-

AMP DUOPLUG 2.5 Female Connectors Selectively Loaded

Pos.	Part Number	DGB I (0.22-0.35)/ DGB II	SL: Cavities Loaded	Color Code	UL 94 V0+GWT 750°C (No Flame)	Side locking	PCB Locking
9	4-284866-9	DGB I	1/3/4/6/8/9	Brown	-	✓	-
9	8-284866-9	DGB I	1/2/4/6/8/9	Red	-	✓	-
9	1-293153-9	DGB I	1/2/4/5/6/7/8/9	Blue	-	-	-
9	2-284931-9	DGB I	1/3/4/6/8/9	Green	-	-	-
9	284931-9	DGB I	1/2/4/6/7/9	Blue	-	-	-
9	293153-9	DGB I	1/3/4/6/8/9	Black	-	-	-
9	3-284866-9	DGB I	1/3/5/6/7/9	Red	-	✓	-
9	5-284866-9	DGB I	1/2/3/5/7/9	Orange	-	✓	-
9	6-284866-9	DGB I	1/3/5/7/8/9	Black	-	✓	-
9	7-284866-9	DGB I	1/3/4/6/8/9	Grey	-	✓	-
10	2-1534557-0	DGB I	2/3/4/5/6/7/9/11	Natural	-	-	✓
10	1-284931-0	DGB I	1/3/5/7/8/10	Blue	-	-	-
10	6-1534557-0	DGB I	2/4/6/7/8/9/10/11	Natural	-	-	✓
10	7-1534557-0	DGB I	2/3/4/5/6/7/9/11	Natural	-	-	✓
11	1-284931-1	DGB I	1/3/5/7/9/11	Blue	-	-	-
11	1-293207-1	DGB I	1/3/5/7/9/11	Green	✓	-	-
11	2-293207-1	DGB I	1/2/3/5/7/9/11	Orange	✓	-	-
11	3-966481-1	DGB I	1/3/5/7/9/11	Natural	-	-	-
12	1-1355181-2	DGB II	1/3	Natural	-	-	✓
12	1-1987611-2	DGB I	1/3	Natural	-	-	-
12	1-284866-2	DGB I	1/3/4/6/7/9/11/12	Blue	-	✓	-
13	3-966481-3	DGB I	1/3/5/7/9/11/13	Natural	-	-	-
14	1-284866-4	DGB I	1/3/4/6/11/12/13/14	Blue	-	✓	-
14	5-284866-4	DGB I	1/3/4/6/8/9/10/11/12/13/14	Green	-	✓	-
17	3-966481-7	DGB I	1/3/5/7/9/11/13/15/17	Natural	-	-	-
19	3-966481-9	DGB I	1/3/5/7/9/11/13/15/17/19	Natural	-	-	-

Introduction

Applications

- Household Appliances
- Small Appliances
- Components
- Gambling Machines
- Heating



The AMP DUOPLUG power connector is a economical IDC connector system for safe and fast production of electrical connections.

The design is based on the RAST 2.5 standard as a direct and indirect connecting system for the PC board and component applications.

The female connectors fit in existing RAST 2.5 headers and frames.

The twisted contact, the design of the contact zone and the two IDC slots guarantee safe functioning and a current rating up to 6 A.

Suitable are 7-stranded and multi-stranded conductors for a wire range of 0.35 mm² up to 0.75 mm² (AWG 22 up to AWG 18, AWM Style 1569/1007).

The cover provides very good contact protection and has openings for easy electrical inspection.

As termination equipment we offer a complete range from the hand tool up to the modular fully-automatic machine IHM Mark III.

The connector keying and color marking is done with units on the workstation.

The IDC connector system AMP DUOPLUG power connector and AMP DUOPLUG 2.5 mark II are able to be processed with minimal set-up times on the same workstation.

AMP DUOPLUG 2.5 PC Board Frame

Pos.	Part Number	UL 94 V0	GWT 750°C (No Flame)	Color Code
3	1-964575-3	✓	–	Black
3	3-964575-3	✓	✓	Natural
3	7-964575-3	✓	✓	Natural
3	8-964575-3	✓	✓	Natural
3	9-964575-3	✓	–	Black
4	2-964575-4	✓	–	Black
4	3-964575-4	✓	–	Black
4	9-964575-4	✓	✓	Natural
5	1-964575-5	✓	–	Black
5	2-964575-5	✓	–	Black
5	4-964575-5	✓	–	Black
5	7-964575-5	✓	✓	Natural
5	8-964575-5	✓	✓	Natural
6	1-964575-6	✓	–	Black
6	2-964575-6	✓	–	Black
7	1-964575-7	✓	–	Black
7	2-964575-7	✓	–	Black
7	3-964575-7	✓	–	Black
7	8-964575-7	✓	✓	Natural
8	1-964575-8	✓	–	Black
8	2-964575-8	✓	–	Black
8	9-964575-8	✓	✓	Natural
8	1-964876-8	✓	–	Black
9	1-964575-9	✓	–	Black
9	2-964575-9	✓	–	Black
9	9-964575-9	✓	✓	Natural
10	2-964575-0	✓	–	Black
11	1-964576-1	✓	–	Black
11	2-964576-1	✓	–	Black

AMP DUOPLUG 2.5 PC Board Frame

Pos.	Part Number	UL 94 V0	GWT 750°C (No Flame)	Color Code
12	2-964576-2	√	-	Black
12	3-964576-2	√	-	Natural
14	1-964576-4	√	-	Black
15	1-964576-5	√	-	Black
16	1-964576-6	√	-	Black
17	1-964576-7	√	-	Black
17	2-964576-7	√	-	Black
18	1-964576-8	√	-	Black
20	1-964576-0	√	-	Black

DUOPLUG 2.5 Male Connector-Panel mount

Pos.	Part Number	Type of Mount	V0/GWT	Raw Material	Counter Part	Image
5 Position	293036-1	Panel mount	UL94 V2 + GWT 750 No Flame	PA 66	5 Pos Duoplug Rast 2.5 connecor	

Introduction

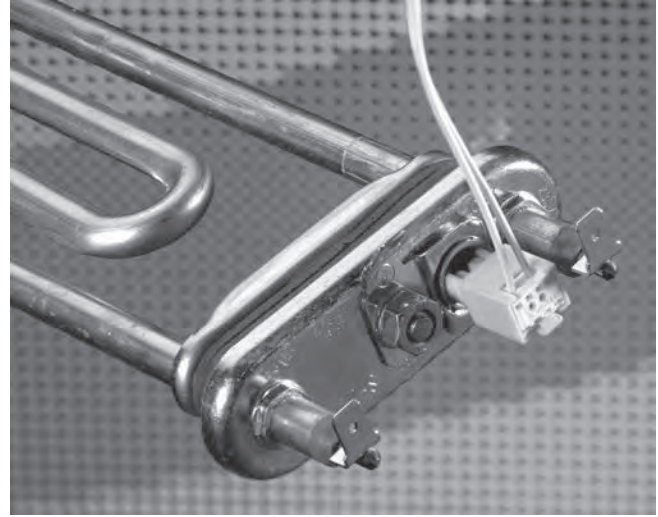
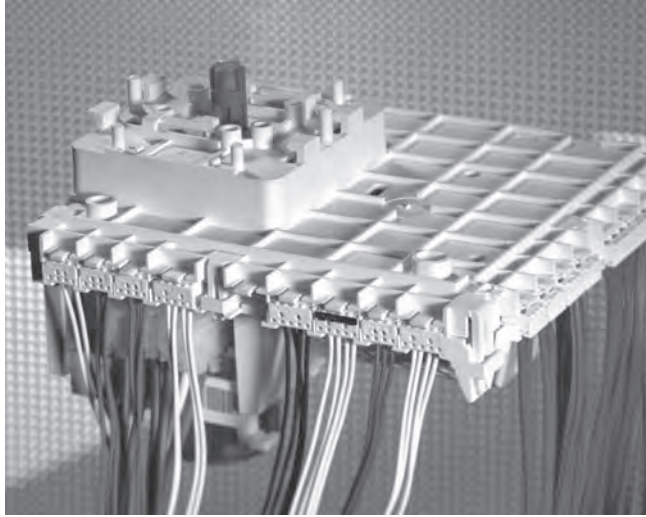

Applications

- Household Appliances
- Small Appliances
- Gambling Machines
- Consumer Electronics
- Telecommunications Industry
- Automotive Industry
- Vending Machines
- Measuring Devices and Others
- Specific Silicone-IDC wires are applicable

TE's developed AMP DUOPLUG 2.5 Mark II IDC connector system merges decades of experience in IDC technology, with the latest materials, processes and processing equipment.

The design is based on the RAST 2.5 standard as a direct and indirect connecting system for the PC board and component applications.

The female connectors fit in existing RAST 2.5 headers and frames.

The twisted contact, the design of the contact zone and the two IDC slots guarantee safe functioning and a current rating up to 2 A.

The 7- and 12-stranded conductors are suitable for a wire range of 0.22 up to 0.35 mm² (AWG 24 up to AWG 22, AWM Style 1569/1007) with a max. insulation diameter of 1.6 mm.

The cover provides very good contact protection and has openings for easy electrical inspection.

We offer a complete range of termination equipment from the hand tool to the modular, fully-automatic IHM (IDC Harness Maker) Mark III machine.

The connector keying and colour marking is done with units on the workstation. AMP DUOPLUG 2.5 Mark II and AMP DUOPLUG power connector can be processed with minimal set-up times on the same workstation.

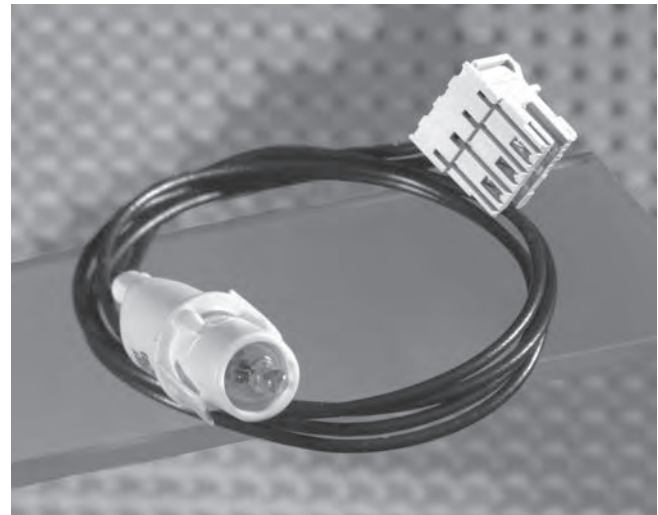
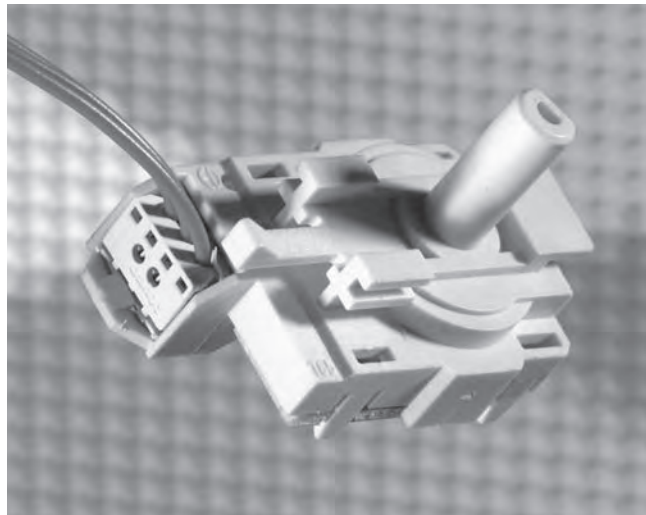

Technical Features

Product Features

- IDC connector system for harness production
- For PC board and electrical component applications
- Designed according to RAST 2.5 Standard
- 2.5 mm Centerline
- Openings in cover for electrical tests
- Excellent contact protection
- Keyable female connector
- Chainable products for optimal handling in logistics and manufacturing
- Special Version
Optional internal locking for secure retention to PC board without use of frame
- VDE Approval-No. 40003624
Reg.-No. 1702000-1431-0046/17189
- UL recognised under File No. E 28476

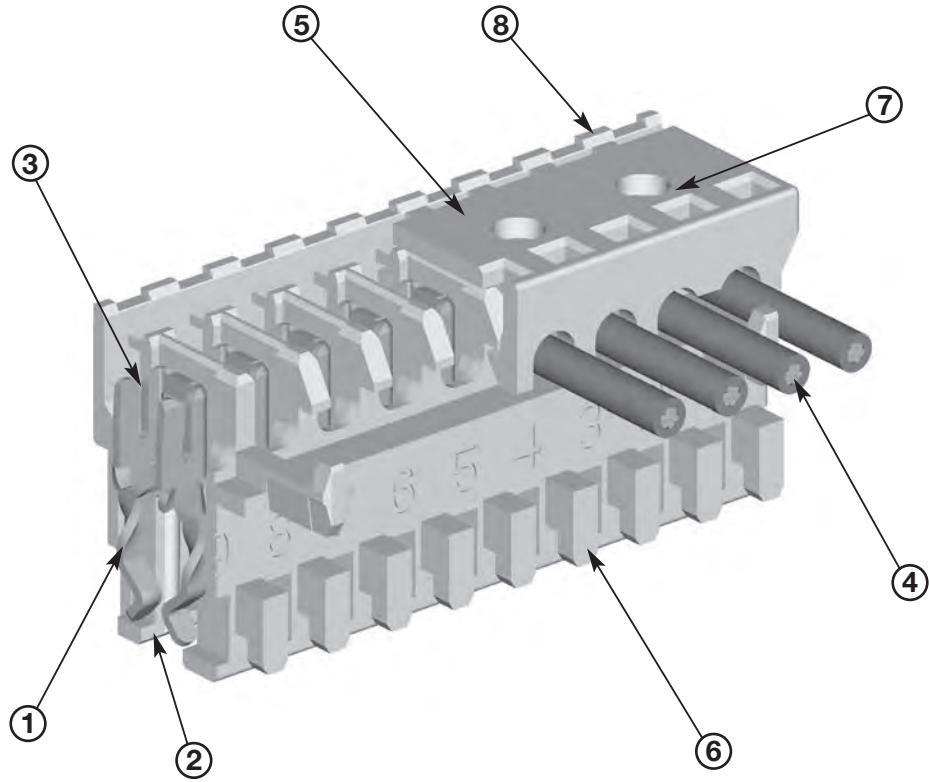

- | | | |
|---|---|--|
| <p>1 Twisted contact provides high contact force without excessive mating force.</p> <p>2 Very good contact protection eliminates stubbing problems.</p> <p>3 Wires are terminated via metal stuffer in tooling which ensures proper positioning of the wire in the IDC slot of contact.</p> | <p>4 Contacts are suitable for 7-stranded and multi-stranded wire.</p> <p>5 Cover provides contact protection.</p> <p>6 Cutting of the keying ribs, in accordance to customers demand, is done during the termination process.</p> | <p>7 Openings in cover for electrical inspection.</p> <p>8 Optional colour marking can be done during the termination process.</p> |
|---|---|--|

Indirect and Direct Connection, 2.5 mm Centerline

**Indirect Connection,
2.5 mm Centerline**

- 1 Cover
- 2 Wire
- 3 Keying ribs
- 4 Tab header
- 5 Tab contact (1.5 x 0.6 mm)
- 6 Keying
- 7 PC board

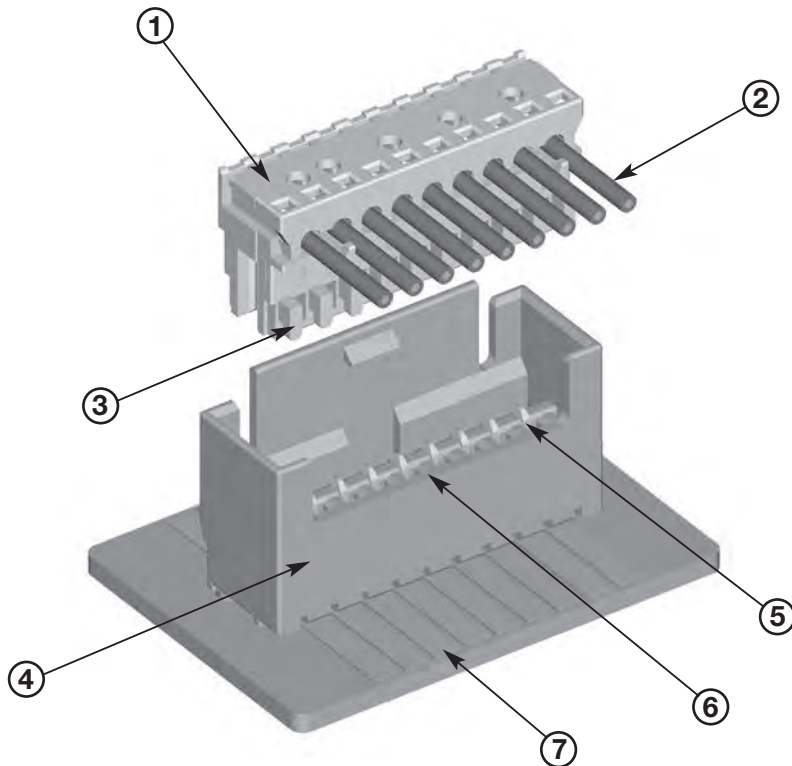

**Direct Connection,
2.5 mm Centerline**

- 1 Cover
- 2 Wire
- 3 Keying ribs
- 4 PC board frame
- 5 Keying
- 6 PC board

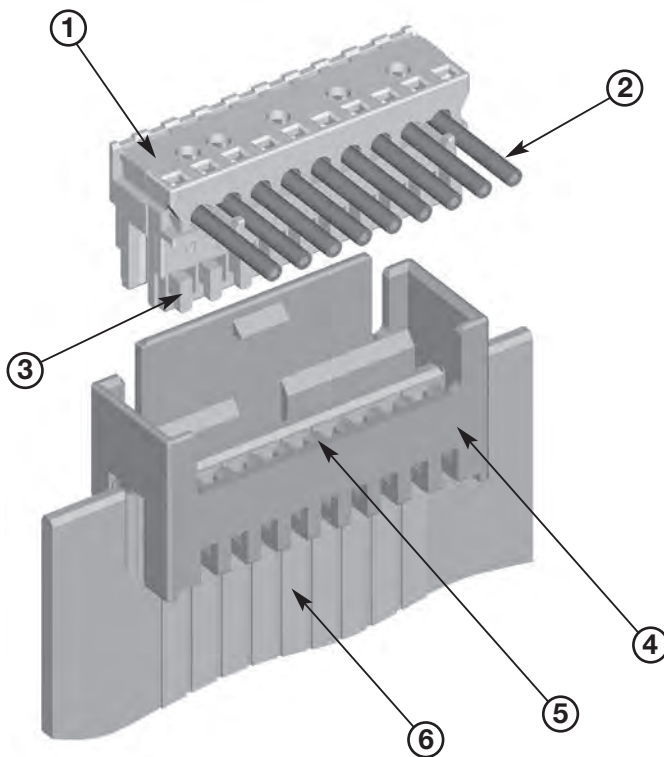

Technical Data

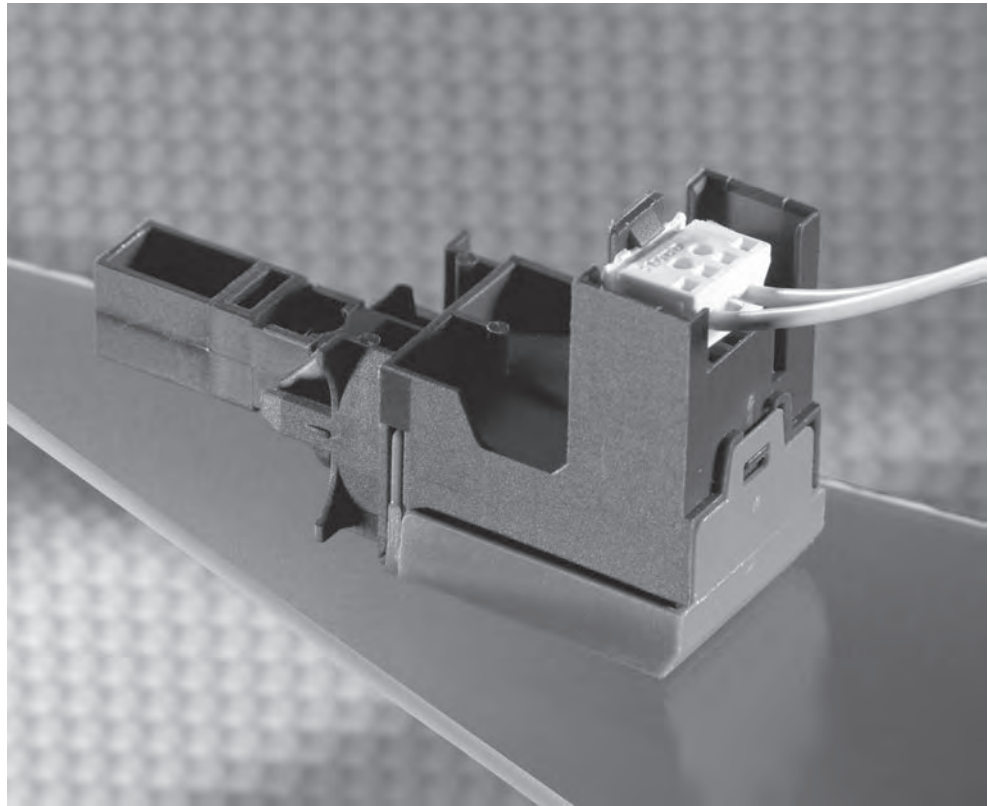

No. of Positions:
3- to 20-positions

Centerline:
2.5 mm,
adjacent with loss of pitch

Housing Material:
PA 6 GF (Polyamide)

Flammability Rating:
UL 94 V-2

Track Resistance:
PTI 250

Insulation Resistance:
>5 m Ω

Housing Colour:
natural

Colour Marking/Key Coding:
done by termination equipment

Contact Material:
Phosphor Bronze (CuSn)

Contact Finish:
tin plated

Temperature Range:
-40 °C up to +110 °C

Current Rating:
2 A max.

Current Voltage:
50 V fully loaded,
250 V selectively loaded

Air and Creepage Distance:
1 mm fully loaded,
>3.2 mm selectively loaded

**Mating Force per Contact
on Steel Gauge:**
6 N max.

Unmating Force per Contact:
0.7 N min.

Wire Size Range:
0.22–0.35 mm² (AWG 24–22,
AWM Style 1569/1007)

Composition of Conductors:
7- and 12-stranded

Insulation Hardness:
Shore A 92 \pm 3

Insulation Diameter:
1.2–1.6 mm

PC Board Thickness:
1.5 \pm 0.14 mm

Approval:

- VDE-Approval-No. 40003624
- VDE-Reg.-No.
1702000-1431-0046/17189
- UL File E 28476

Product Specification:
108-18785

Packaging Specification:
107-18068

Application Specification:
114-18467

Performance Diagrams

Technical Data

■ **Female Connector, 20 Positions**
Part-No. 3-1534797-0

■ **Material and Finish**
Housing Material:
PA 6 GF, acc. UL 94 V-2
Contact Material:
Phosphor Bronze (CuSn)
Contact Finish:
tin plated

■ **Wire Range:**
0.22 mm² (7-strands,
tin plated)
0.35 mm² (12-strands,
tin plated)

■ **Counter Part**
PC board:
one side coated
Pad:
0.35 µm x 1.9 mm,
Copper, HAL, tin plated

■ **Measurement Construction:**
(1): 0.22 mm²
(2): 0.35 mm²

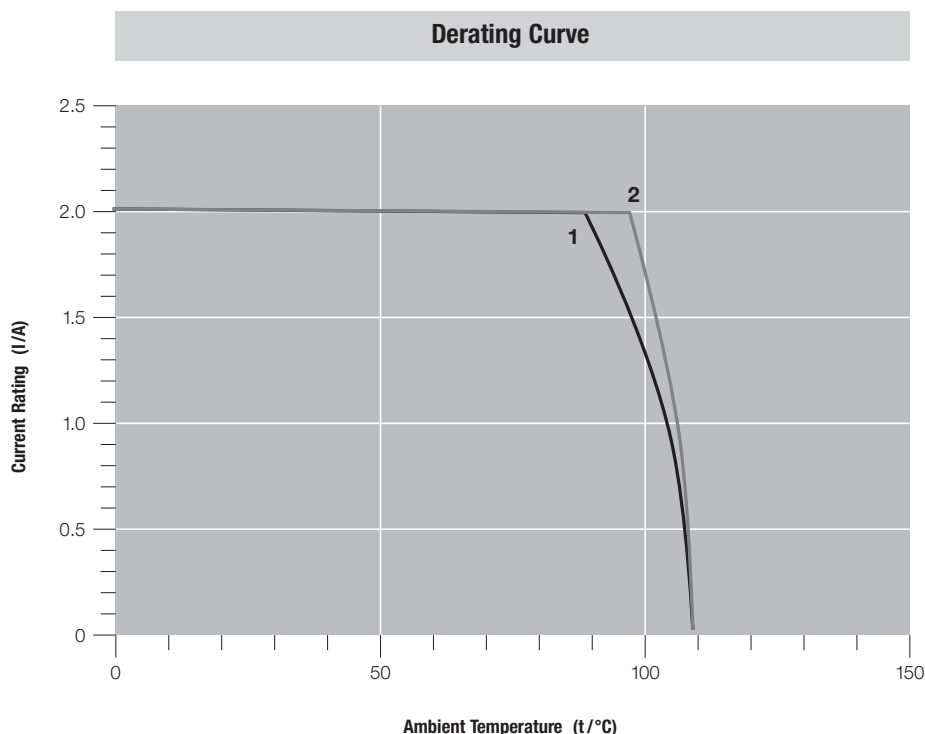
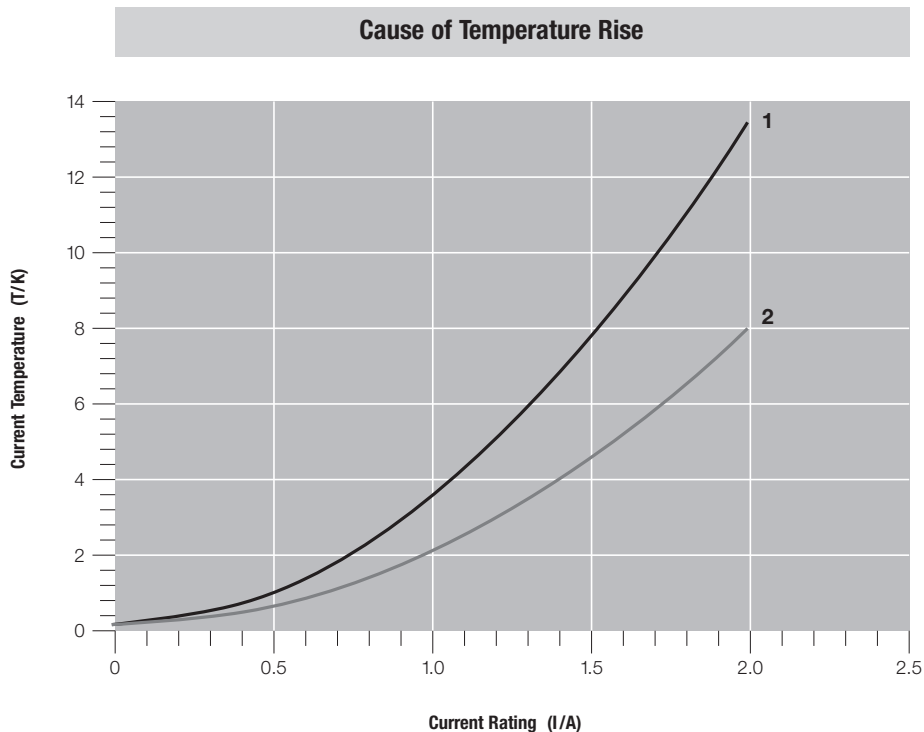

Performance Diagrams (continued)

Technical Data

■ **Female Connector, 20 Positions**
Part-No. 3-1534797-0

■ **Material and Finish**
Housing Material:
PA 6 GF, acc. UL 94 V-2
Contact Material:
Phosphor Bronze (CuSn)
Contact Finish:
tin plated

■ **Wire Range:**
0.22 mm² (7-strands, tin plated)
0.35 mm² (12-strands, tin plated)

■ **Counter Part**
Tab header
Housing:
PBT-GF, acc. UL 94 V-0
Pin:
1.5 x 0.6 mm, CuZn 30, tin plated

■ **Measurement Construction:**
(1): 0.22 mm²
(2): 0.35 mm²

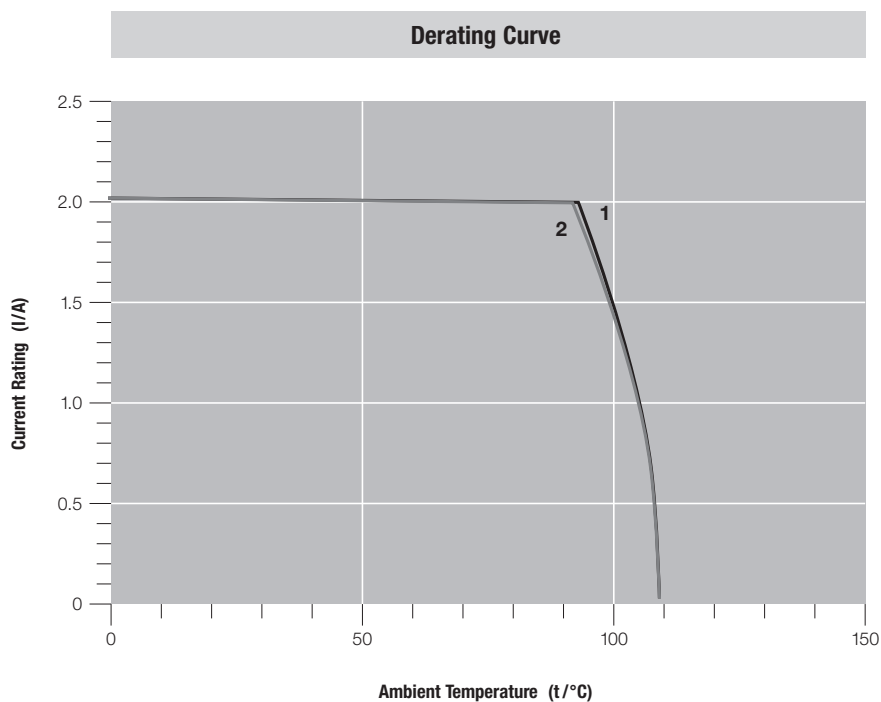
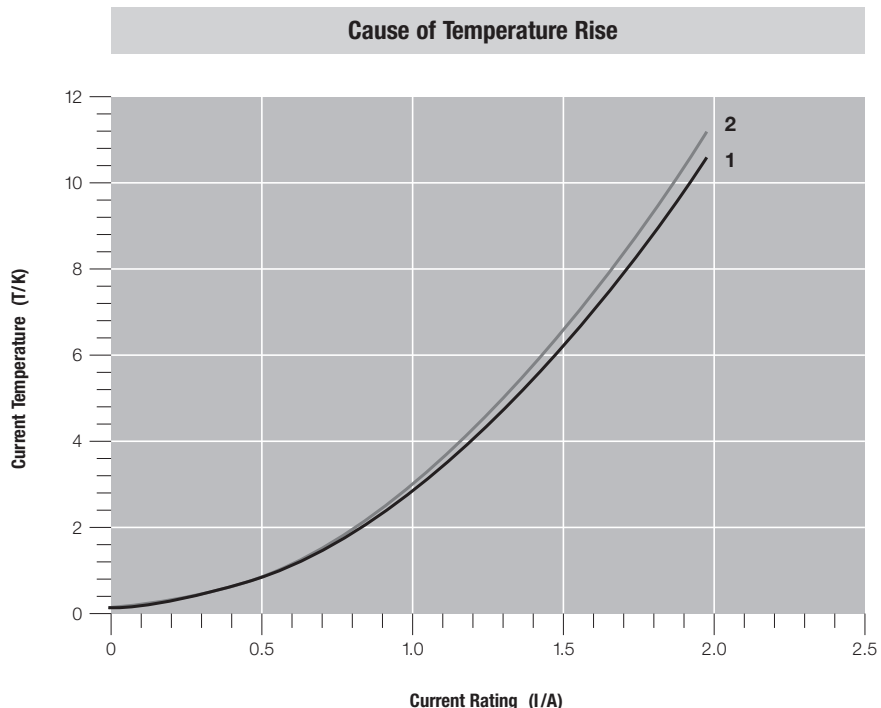

Keying Plan and Female Connector Geometry

Keying Plan

Delivery Form

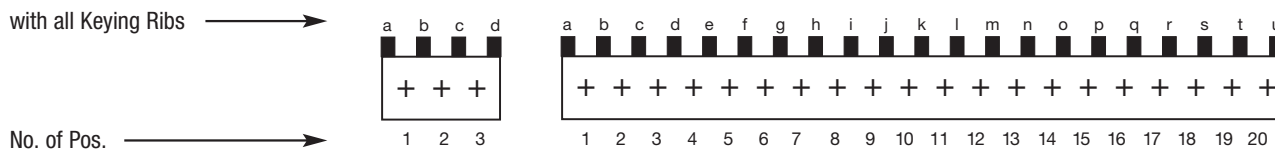

Keying Example: 3/2 positions

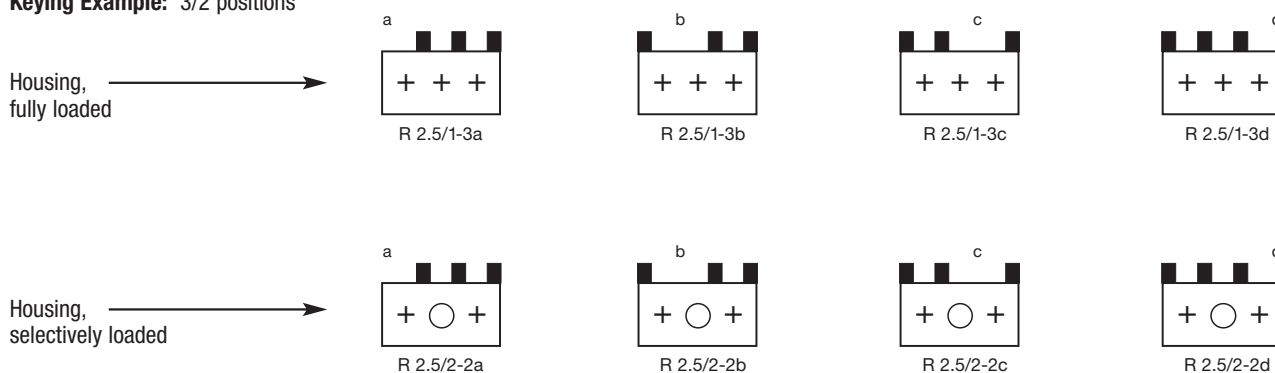

Keying is done by unit during application process.

AMP DUOPLUG 2,5 Mark II Female Connector

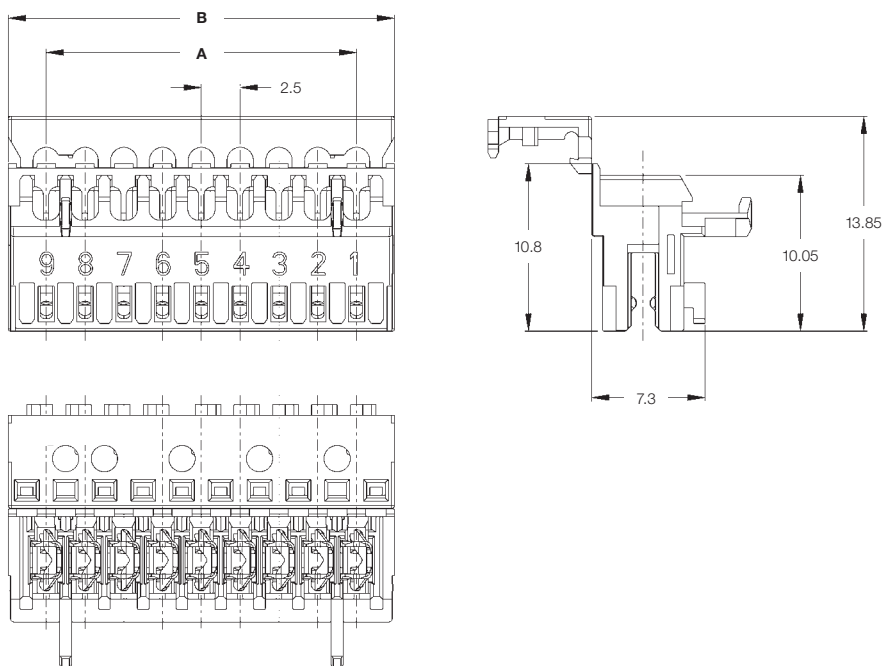

AMP DUOPLUG 2.5 Mark II Female Connectors Fully Loaded

Pos.	Part Number	UL 94 V0/V2	GWT 750°C (No Flame)	PCB Locking
3	3-1534796-3	V2	√	-
3	6-1534796-3	V2	√	-
3	7-1534796-3	V2	√	-
3	9-1534796-3	V2	√	-
3	9-1740154-3	V2	√	-
3	1-1740501-3	V2	√	√
4	3-1534796-4	V2	√	-
4	4-1534796-4	V2	√	-
4	1-1740501-4	V2	√	√
5	3-1534796-5	V2	√	-
5	2-1740501-5	V2	√	√
6	3-1534796-6	V2	√	-
6	4-1534796-6	V2	√	-
6	9-1740154-6	V2	√	-
6	1-1740501-6	V2	√	√
6	2-1740501-6	V2	√	√
7	3-1534796-7	V2	√	-
8	5-1534796-8	V2	√	-
8	3-1534796-8	V2	√	-
9	3-1534796-9	V2	√	-
10	3-1534796-0	V2	√	-
10	7-1534796-0	V2	√	-
11	3-1534797-1	V2	√	-
11	4-1534797-1	V2	√	-
11	1740525-1	V2	√	-
12	3-1534797-2	V2	√	-
12	4-1534797-2	V2	√	-
13	3-1534797-3	V2	√	-
14	3-1534797-4	V2	√	-

AMP DUOPLUG 2.5 Mark II Female Connectors Selectively Loaded

Pos.	Part Number	UL 94 V0/V2	GWT 750°C (No Flame)	PCB Locking
3	3-1534798-3	V2	√	-
3	4-1534798-3	V2	√	-
3	5-1534798-3	V2	√	-
3	1-1740918-3	V2	√	√
3	2-1740918-3	V2	√	√
5	3-1534798-5	V2	√	-
5	4-1534798-5	V2	√	-
6	3-1534798-6	V2	√	-
6	4-1534798-6	V2	√	-
6	5-1534798-6	V2	√	-
6	7-1534798-6	V2	√	-
7	3-1534798-7	V2	√	-
7	4-1534798-7	V2	√	-
8	3-1534798-8	V2	√	-
8	4-1534798-8	V2	√	-
8	5-1534798-8	V2	√	-
8	6-1534798-8	V2	√	-
8	7-1534798-8	V2	√	-
8	8-1534798-8	V2	√	-
9	1-1534798-9	V2	√	-
9	3-1534798-9	V2	√	-
9	4-1534798-9	V2	√	-
9	5-1534798-9	V2	√	-
9	6-1534798-9	V2	√	-
10	4-1534798-0	V2	√	-
11	3-1534799-1	V2	√	-
11	4-1534799-1	V2	√	-
11	1740527-1	V2	√	-

AMP DUOPLUG 2.5 Mark II Female Connectors Selectively Loaded

Pos.	Part Number	UL 94 V0/V2	GWT 750°C (No Flame)	PCB Locking
13	3-1534799-3	V2	√	-
13	4-1534799-3	V2	√	-
19	1-1534799-9	V2	√	-

Introduction

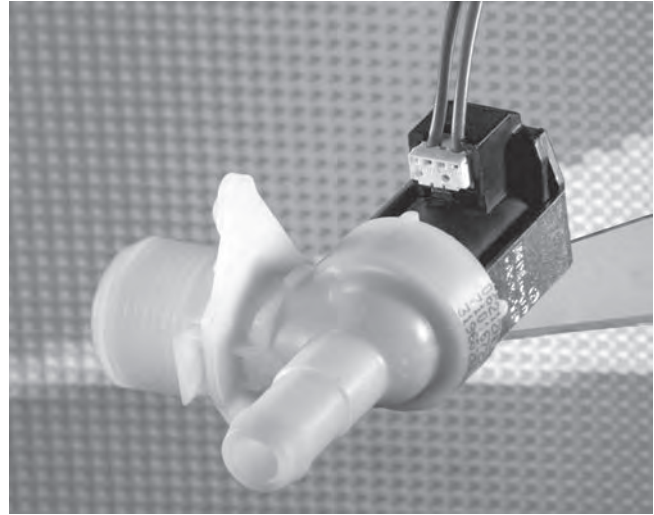
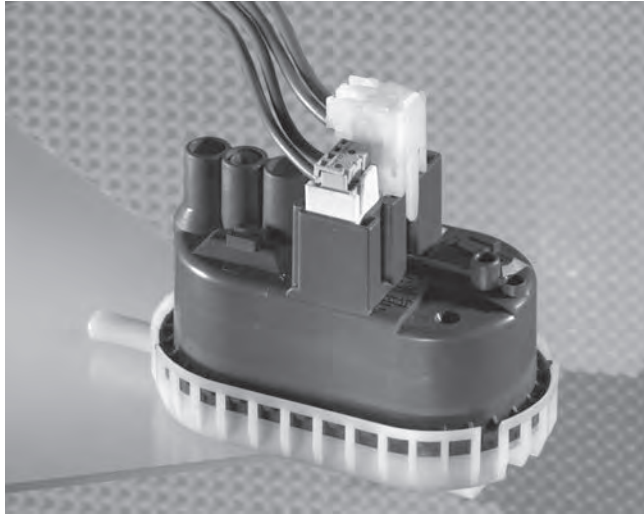

Applications

- Household Appliances
- Small Appliances
- Components
- Gambling Machines
- Heating

The AMP DUOPLUG power connector is a economical IDC connector system for safe and fast production of electrical connections.

The design is based on the RAST 2.5 standard as a direct and indirect connecting system for PC board and component applications.

The female connectors fit in existing RAST 2.5 headers and frames.

The twisted contact, the design of the contact zone

and the two IDC slots ensure safe functioning and a current rating up to 6 A.

The 7-stranded and multi-stranded conductors are suitable for a wire range of 0.35 mm² up to 0.75 mm² (AWG 22 up to AWG 18, AWM Style 1569/1007).

The cover provides very good contact protection and has openings for easy electrical inspection.

We offer a complete range of termination equipment from the hand tool to the

modular fully-automatic IHM Mark III machine.

The connector keying and colour marking is done with units on the workstation.

AMP DUOPLUG power connector and AMP DUOPLUG 2.5 Mark II IDC connector systems are able to be processed with minimal set up time on the same workstation.

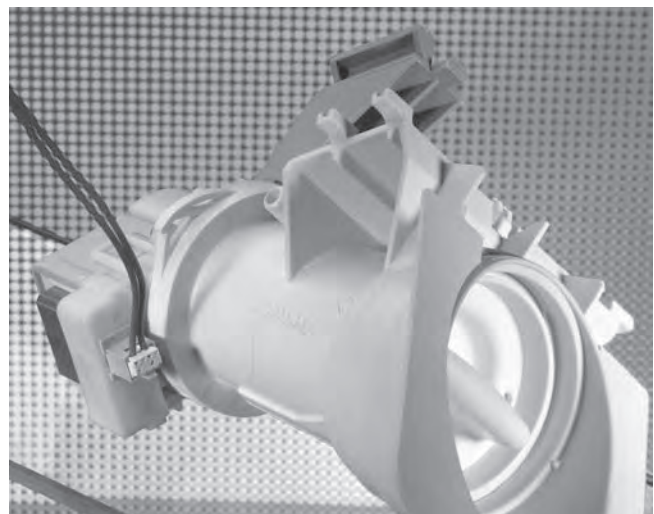
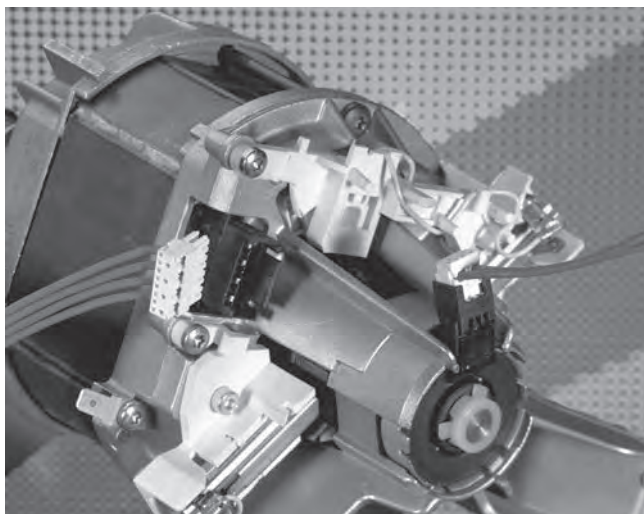

Technical Features

Product Features

- IDC connector system for harness production
- For PC board and electrical component application
- Designed according to RAST 2.5 Standard
- Low housing height
- 5.0 mm Centerline
- Excellent contact protection
- Keyable female part
- Chainable products for optimal handling in logistics and manufacturing
- Special Version
Optional internal locking for secure retention to PC board without use of frame
- VDE Approval-No. 40003581
Reg.-No. 1702000-1431-0045/11473
- UL recognised under File No. E 28476

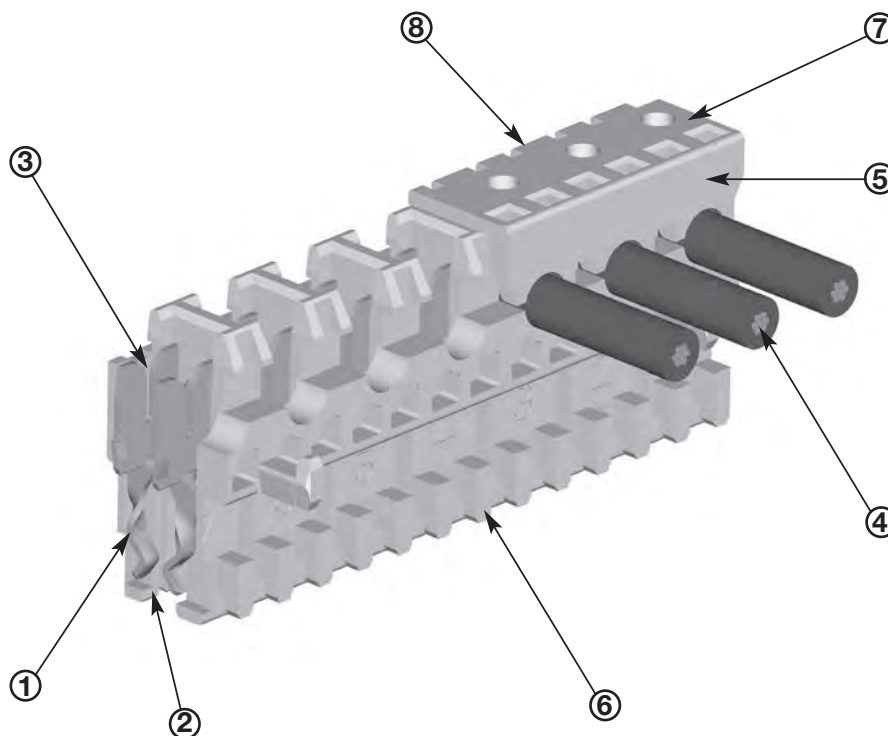

- | | | |
|--|--|--|
| <p>1 Twisted contact provides high contact force without excessive mating force.</p> <p>2 Very good contact protection eliminates stubbing problems.</p> <p>3 Wires are terminated via metal stuffer in tooling which ensures proper positioning of the wire in the IDC slot of contact.</p> | <p>4 Contacts are suitable for 7-stranded and multi-stranded wire.</p> <p>5 Cover provides contact protection.</p> <p>6 Cutting of the keying ribs, in accordance to customers demand, is done during the termination process.</p> | <p>7 Openings in cover for electrical inspection.</p> <p>8 Optional colour marking can be done during the termination process.</p> |
|--|--|--|

Indirect and Direct Connection, 5.0 mm Centerline

**Indirect Connection,
5.0 mm Centerline**

- 1 Cover
- 2 Wire
- 3 Keying ribs
- 4 Tab header
- 5 Tab contact (1.5 x 0.6 mm)
- 6 Keying
- 7 PC board

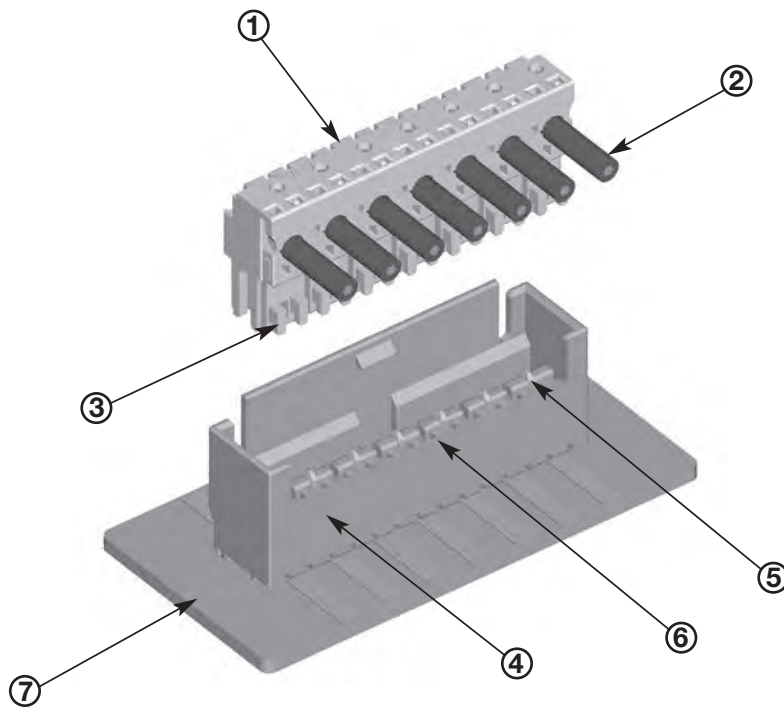

**Direct Connection,
5.0 mm Centerline**

- 1 Cover
- 2 Wire
- 3 Keying ribs
- 4 PC board frame
- 5 Keying
- 6 PC board

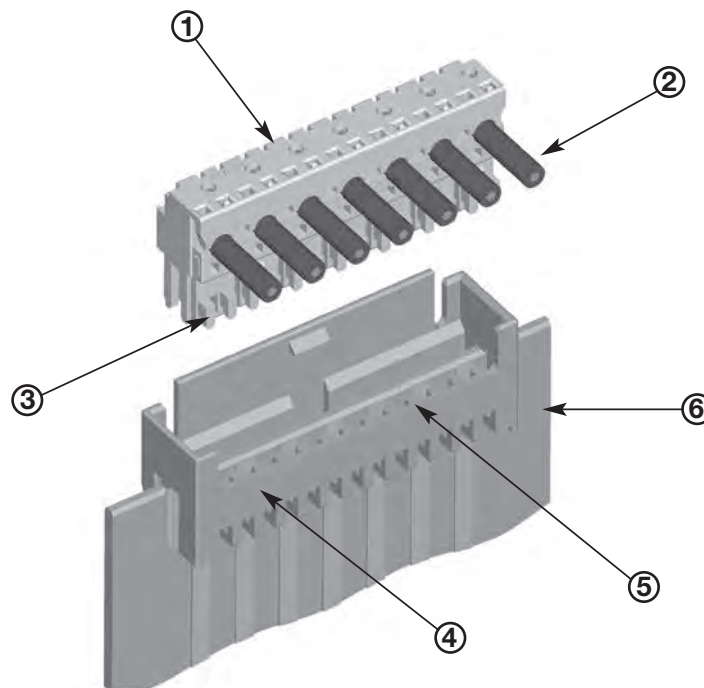

Technical Data

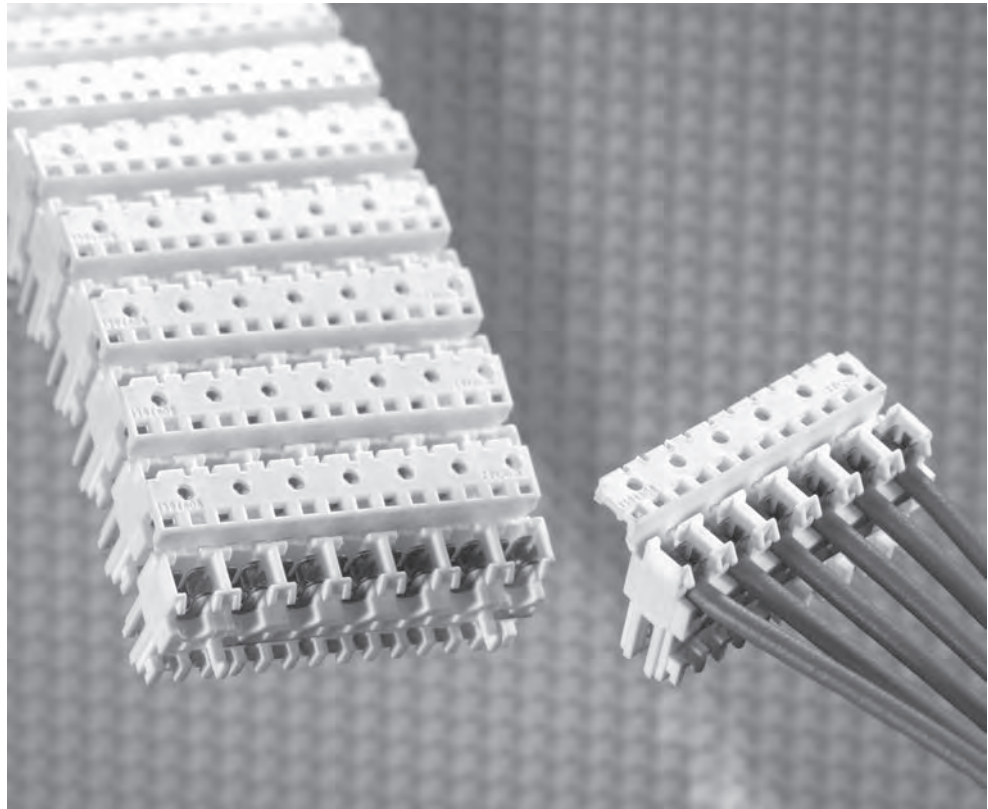

No. of Positions:
2- to 9-positions

Centerline:
5.0 mm, adjacent

Housing Material:
PA 6.6 and PA 6 (Polyamide)

Flammability Rating:
UL 94 V-0 and UL 94 V-2

Track Resistance:
PTI 250

Insulation Resistance:
>5 m Ω

Housing Colour:
pale grey, natural

Colour Marking/Key Coding:
done by termination equipment

Contact Material:
CuNiSi

Contact Finish:
tin plated

Temperature Range:
-40 °C to +110 °C

Current Rating:
6 A max.

Rated Voltage:
250 V

Air and Creepage Distance:
 ≥ 3.2 mm

Mating Force per Contact on Steel Gauge:
6 N max.

Unmating Force per Contact:
0.7 N min.

Wire Size Range:
0.35–0.75 mm² (AWG 22–18,
AWM Style 1569/1007)

Composition of Conductors:
7-stranded and fine stranded

Insulation Hardness:
Shore A 92 \pm 3

Insulation Diameter:
1.2–2.4 mm

PC Board Thickness:
1.5 \pm 0.14 mm

Approval:

- VDE-Approval-No. 40003581
- VDE-Reg.-No. 1702000-1431-0045/11473,
- UL File E 28476

Product Specification:
108-18780

Packaging Specification:
107-18068

Application Specification:
114-18458

Performance Diagrams

Technical Data

■ **Female Connector, 9 Positions**
Part-No. 394918-9

■ **Material and Finish**
Housing Material:
PA 6.6, acc. UL 94 V-0 and
PA 6, acc. UL 94 V-2
Contact Material:
CuNiSi
Contact Finish:
tin plated

■ **Wire Range:**
0.5 mm² , 16-strands

■ **Counter Part**
PC board:
Single side and double side
coated
Pad:
0.35 μm x 1.9 mm,
Copper, HAL, tin plated
Tab Header:
Pin 1.5 x 0.6 mm,
CuZn 30, tin plated

■ **Measurement:**
(1): CEM1, single side
coated
(2): FR4, double side coated
(3): PBT-GF, Tab Header

Cause of Temperature Rise

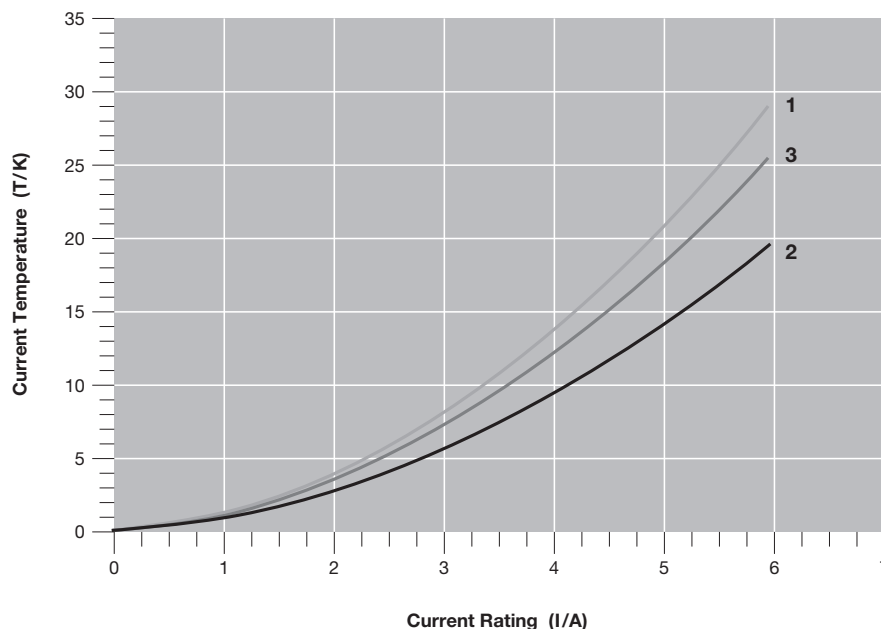

Derating Curve

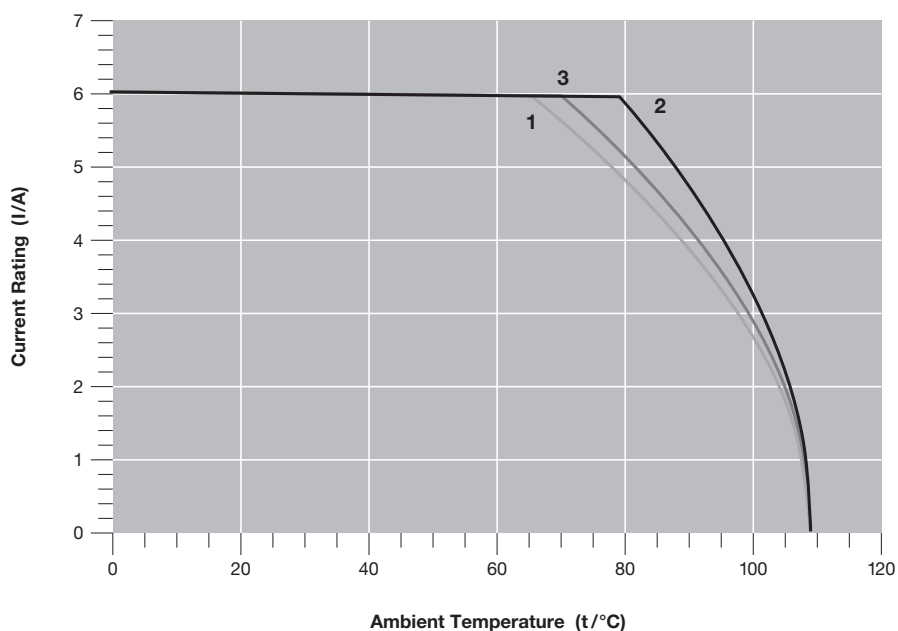

Keying Plan

1394918-2
1534415-2

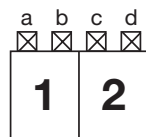

1-1394918-2
1-1534415-2

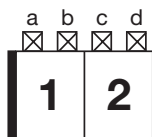

2-1394918-2
2-1534415-2

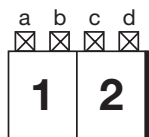

3-1394918-2
3-1534415-2

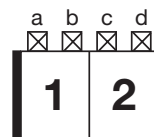

1394918-3
1534415-3

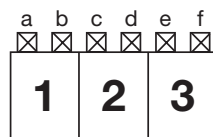

1-1394918-3
1-1534415-3

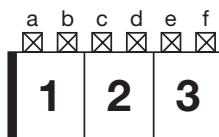

2-1394918-3
2-1534415-3

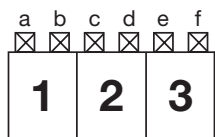

3-1394918-3
3-1534415-3

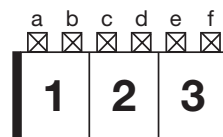

1394918-9
1534415-9



View Z

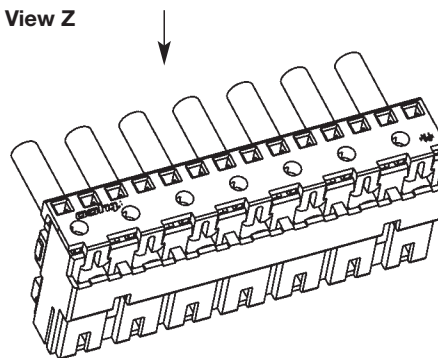

Possible Keying
Example R2.5 / P-3b,d

1394918-3
1534415-3

Keying is done with units during application process.

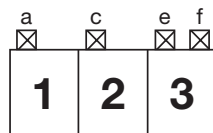

PC Board Layout

PC board layout keyed,
connected only with additional
guide frame

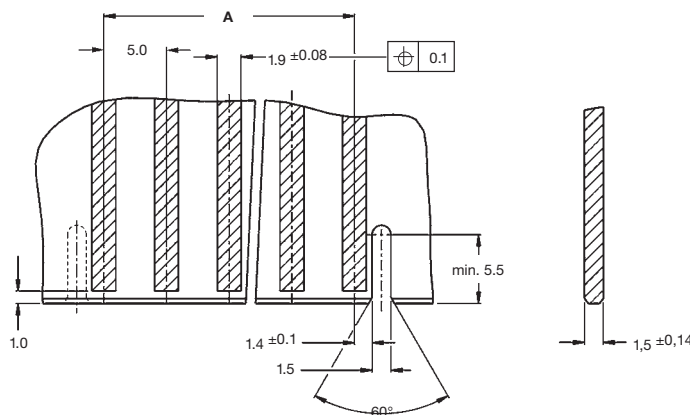

10
AMP DUOPLUG Power

AMP DUOPLUG Power Female Connectors Fully Loaded

Pos.	Part Number	UL 94 V0/V2	GWT 750°C (No Flame)	PCB Locking	Color Code
2	1394918-2	V0	-	-	Natural
2	1-1394918-2	V0	-	-	Natural
2	2-1394918-2	V0	-	-	Natural
2	1534415-2	V2	√	-	Natural
2	1-1534415-2	V2	√	-	Natural
2	2-1534415-2	V2	√	-	Natural
2	3-1534415-2	V2	√	-	Natural
2	1740533-2	V2	√	√	Green
2	1-1740533-2	V2	√	√	Red
2	2-1740533-2	V2	√	√	Natural
3	1394918-3	V0	-	-	Natural
3	1-1394918-3	V0	-	-	Natural
3	2-1394918-3	V0	-	-	Natural
3	1534415-3	V2	√	-	Natural
3	1-1534415-3	V2	√	-	Natural
3	1-1534415-3	V2	√	-	Natural
3	1740533-3	V2	√	√	Natural
3	1-1740533-3	V2	√	√	Black
3	1740924-3	V0	√	-	Natural
4	1394918-4	V0	-	-	Natural
4	1534415-4	V2	√	-	Natural
4	1-1740533-4	V2	√	√	Blue
4	2-1740533-4	V2	√	√	Brown
4	3-1740533-4	V2	√	√	Brown
5	1394918-5	V0	-	-	Natural
5	1534415-5	V2	√	-	Natural
5	1740533-5	V2	√	√	Natural
6	1394918-6	V0	-	-	Natural
6	1534415-6	V2	√	-	Natural

AMP DUOPLUG Power Female Connectors Fully Loaded

Pos.	Part Number	UL 94 V0/V2	GWT 750°C (No Flame)	PCB Locking	Color Code
6	1-1740533-6	V2	√	√	Black
6	2-1740533-6	V2	√	-	Natural
7	1394918-7	V0	-	-	Natural
7	1534415-7	V2	√	-	Natural
7	1740533-7	V2	√	-	Natural
7	1-1740533-7	V2	√	√	Natural
7	2-1740533-7	V2	√	-	Natural
7	3-1740533-7	V2	√	√	Natural
8	1534415-8	V2	√	-	Natural
9	1740533-9	V2	√	√	Green

AMP DUOPLUG Power Female Connectors Selectively Loaded

Pos.	Part Number	UL 94 V0/V2	GWT 750°C (No Flame)	PCB Locking	Color Code
3	4-1534415-3	V2	√	-	Natural
3	3-1740533-3	V2	√	√	Black
3	4-1740533-3	V2	√	√	Black
4	1740533-4	V2	√	√	Brown
6	1740533-6	V2	√	√	Black
6	3-1740533-6	V2	√	√	Black
9	1-1740533-9	V2	√	√	Green

AMP Duoplug Power Male connector

Pos.	Part Number	Type of Mount	V0/GWT	Raw Material	Counter Part	Image
4 Position	293230-1	MOTOR MOUNT	-	PA66	1534415-4 Duoplug Power 4 Pos	
2 Position	1718044-1	Tab header	UL94 V2	PA66	DPMK II and Duoplug Power	
2 Position	1718044-2	Tab header	"UL94 V2 + GWT 750 No Flame"	PA6	DPMK II and Duoplug Power	
2 Position	1718044-3	Tab header	"UL94 V2 + GWT 750 No Flame"	PA6	DPMK II and Duoplug Power	
2 Position	1718044-4	Tab header	"UL94 V2 + GWT 750 No Flame"	PA6	DPMK II and Duoplug Power	

Introduction

PCB Connector that Meets RAST 2.5 Standard

PCB connector that meets RAST 2.5 standard with vertical through hole technology, available with tin or silver plating, external or internal locking.

Key Features

- 1 Designed to the RAST 2.5 Standard
- 2 Tin / Silver plating
- 3 3-15 positions
- 4 Available in multiple colors
- 5 Internal and external locking
- 6 UL/VDE/CQC approval
- 7 Meets UL 94 V0 & GWT 750°C w/o flame
- 8 Fully loaded and selectively loaded options

Applications

- 1 Front-loading washing machine
- 2 Dishwasher
- 3 Microwave oven
- 4 Refrigerator

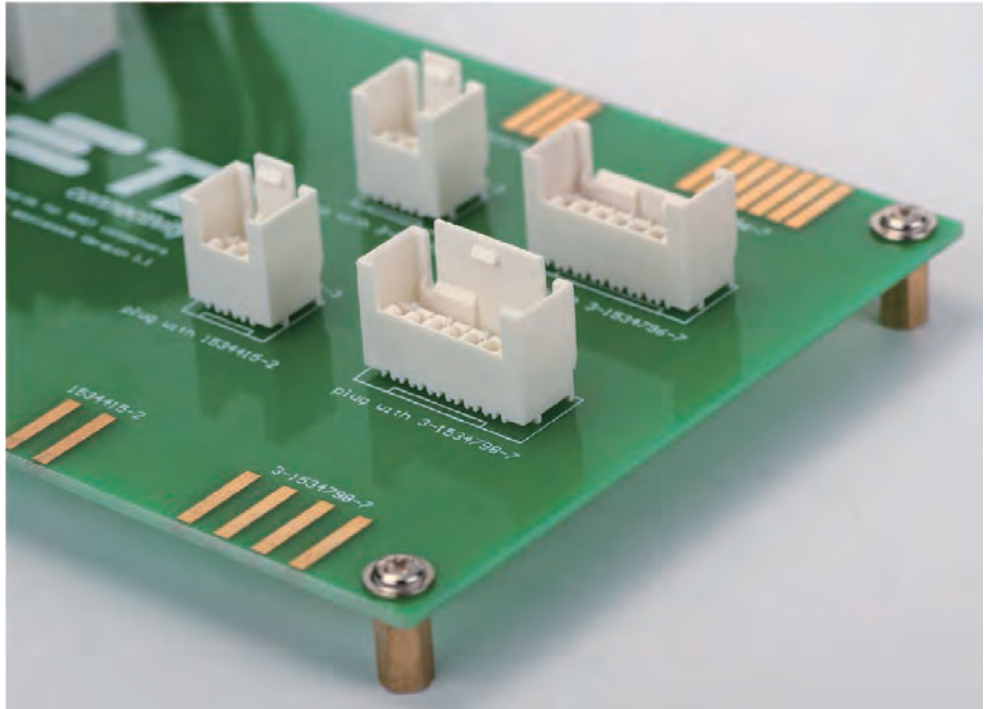

TE's PCB connectors that meets RAST standard come with a broad range of options and comply with most industrial and appliances safety standards, including UL94-V0, IEC 60335-1 (GWT 750°C), as well as certificates of conformity by UL, VDE and CQC.

These product additions offer a more optimized product portfolio and more flexible solutions, and are particularly ideal for wire-to-board connections and

control-units of major appliances and other applications.

Both models also offer choices of tin or silver plating, several different colors and various configurations of keying for customization needs to save cost.

The 2.5 mm-pitch PCB connectors that meet RAST 2.5 standard are available in 3 to 15 positions, 1 footprint layout and external and internal locking types.

Electrical

- 1 Rated Current: 2 A for Tin plated version; 6 A for silver plated version
- 2 Rated Voltage: 50 V for fully loaded version; 250 V for selectively loaded version
- 3 Insulation Resistance: 5000 MΩ
- 4 Dielectric Strength: 1500 V





Materials

- 1 Housing: Meets Thermoplastic UL 94 V0 and IEC 60335-1
- 2 Contact: Copper Alloy, Tin or Silver plating over Nickel

Standards And Specifications

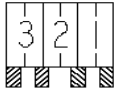
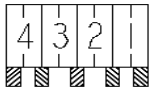
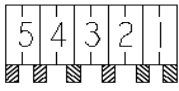
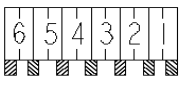

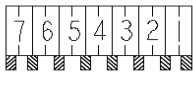







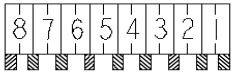

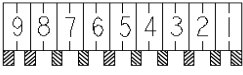
- 1 According to RAST 2.5 Specification
- 2 Product Specification: 108-106079

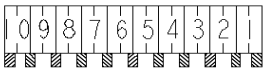
Fully Loaded, External Locking

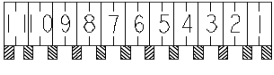
Position	Part Number	Tab Contact Plating	Keying And Locking Latch	Color	Pcb Lay Out
General	#-1971817-#	Tin	-	See table 1	(See fig 1)
	#-1971837-#	Silver			
	#-1971818-#	Tin			
	#-1971838-#	Silver			
3	#-1971817-3	Tin	 1-1971817-3 1-1971837-3	See table 1	(See fig 1)
	#-1971837-3	Silver			
	-	-			
	-	-			
4	#-1971817-4	Tin	 1-1971817-4 1-1971837-4	See table 1	(See fig 1)
	#-1971837-4	Silver			
	-	-			
	-	-			
5	#-1971817-5	Tin	 1-1971817-5 1-1971837-5	See table 1	(See fig 1)
	#-1971837-5	Silver			
	-	-			
	-	-			
6	#-1971817-6	Tin	 1-1971817-6 1-1971837-6 	See table 1	(See fig 1)
	#-1971837-6	Silver			
	-	-			
	-	-			
7	#-1971817-7	Tin	 1-1971817-7 1-1971837-7 	See table 1	(See fig 1)
	#-1971837-7	Silver			
	-	-			
	-	-			

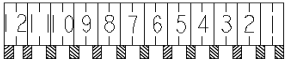

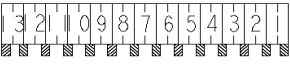
Fully Loaded, External Locking

Position	Part Number	Tab Contact Plating	Keying And Locking Latch	Color	Pcb Lay Out
8	#-1971817-8	Tin	 I-1971817-8  I-1971837-8	See table 1	(See fig 1)
	#-1971837-8	Silver			
	-	-			
	-	-			
9	#-1971817-9	Tin	 I-1971817-9  I-1971837-9	See table 1	(See fig 1)
	#-1971837-9	Silver			
	-	-			
	-	-			
10	#-1971817-0	Tin	 I-1971817-0  I-1971837-0	See table 1	(See fig 1)
	#-1971837-0	Silver			
	-	-			
	-	-			
11	#-1971818-1	Tin	 I-1971818-1  I-1971838-1	See table 1	(See fig 1)
	#-1971838-1	Silver			
	-	-			
	-	-			
12	#-1971818-2	Tin	 I-1971818-2  I-1971838-2	See table 1	(See fig 1)
	#-1971838-2	Silver			
	-	-			
	-	-			
13	#-1971818-3	Tin	 I-1971818-3  I-1971838-3	See table 1	(See fig 1)
	#-1971838-3	Silver			
	-	-			
	-	-			

Fully Loaded, External Locking

Position	Part Number	Tab Contact Plating	Keying And Locking Latch	Color	Pcb Lay Out
14	#-1971818-4	Tin		See table 1	(See fig 1)
	#-1971838-4	Silver			
	-	-			
	-	-			
15	#-1971818-5	Tin		See table 1	(See fig 1)
	#-1971838-5	Silver			
	-	-			
	-	-			

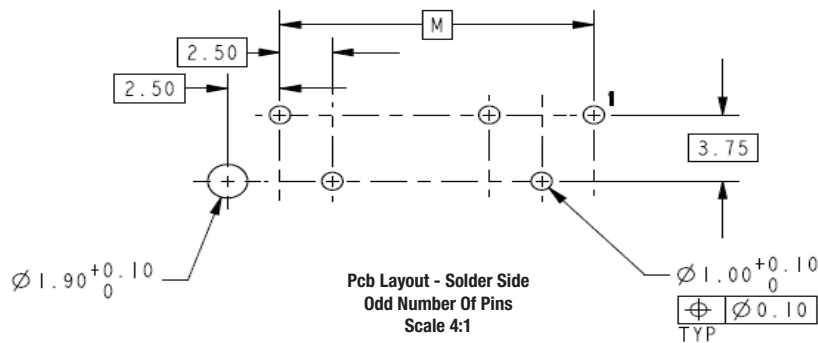

35.00	15
32.50	14
30.00	13
27.50	12
25.00	11
22.50	10
20.00	9
17.50	8
15.00	7
12.50	6
10.00	5
7.50	4
5.00	3
M	NO. OF POS.

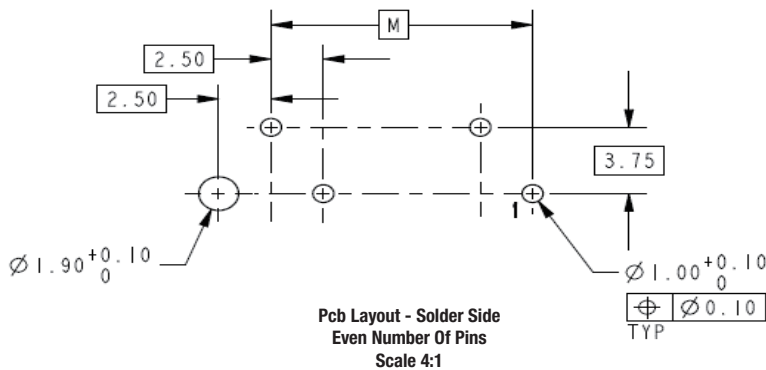

Fig 1

Fully Loaded, External Locking

Table 1

Color	With Tin Plating Contact		With Silver Plating Contact		Comments
Natural	#-1971817-#	#-1971818-#	#-1971837-#	#-1971838-#	
Red	#-1971938-#	#-1971939-#	#-2232141-#	#-2232142-#	
Blue	#-2232143-#	#-2232144-#	#-2232145-#	#-2232146-#	
Yellow	#-2232147-#	#-2232148-#	#-2232149-#	#-2232150-#	
Black	#-1971994-#	#-1971995-#	#-2232151-#	#-2232152-#	
Grey	#-1971976-#	#-1971977-#	#-2232153-#	#-2232154-#	
Green	#-1971988-#	#-1971989-#	#-2232155-#	#-2232156-#	
Purple	#-2232157-#	#-2232158-#	#-2232159-#	#-2232160-#	
White	#-2232289-#	#-2232291-#	#-2232290-#	#-2232292-#	

The Prefix And Postfix Are The Same With The P/N Of The Natural Tab Header For The Same Keying Configuration, Just The Base Numbers Are Different Based On Different Color. * And # Can Be The Number From 0 To 9.

For Any Keying Configuration, There Are Eight Colors Available, Besides The Natural Color, There Are Other Seven Colors, Include: Yellow, Blue, Grey, Purple, Red, Green, Black. The P/n of The Color Tab Header Are Based On The Natural Tab Header, The Prefix And Postfix Are The Same For The Same Keying Configuration, But The Base Numbers Are Different According To Different Color. the Following Shows What's The P/n For Color Tab Header. The Related P/n of The Housing For The Color Tab Header Are Also Based On The Natural Housing, Only The Base Number Is Different.

Fully Loaded, Internal Locking

Position	Part Number	Tab Contact Plating	Keying And Locking Latch	Color	Pcb Lay Out
General	#-1971819-#	Tin			
	#-1971839-#	Silver			
	#-1971820-#	Tin			
	#-1971840-#	Silver			
3	#-1971819-3	Tin		See table 2	(See fig 2)
	#-1971820-3	Silver			
	-	-	1-1971819-3		
	-	-	1-1971839-3		
4	#-1971819-4	Tin		See table 2	(See fig 2)
	#-1971820-4	Silver			
	-	-	1-1971819-4		
	-	-	1-1971839-4		
5	#-1971819-5	Tin		See table 2	(See fig 2)
	#-1971839-5	Silver			
	-	-	1-1971819-5		
	-	-	1-1971839-5		
6	#-1971819-6	Tin		See table 2	(See fig 2)
	#-1971839-6	Silver			
	-	-	1-1971819-6		
	-	-	1-1971839-6		
7	#-1971819-7	Tin		See table 2	(See fig 2)
	#-1971839-7	Silver			
	-	-	1-1971819-7		
	-	-	1-1971839-7		



Fully Loaded, Internal Locking

Position	Part Number	Tab Contact Plating	Keying And Locking Latch	Color	Pcb Lay Out
8	#-1971819-8	Tin		See table 2	(See fig 2)
	#-1971839-8	Silver			
	-	-			
	-	-			
9	#-1971819-9	Tin		See table 2	(See fig 2)
	#-1971839-9	Silver			
	-	-			
	-	-			
10	#-1971819-0	Tin		See table 2	(See fig 2)
	#-1971839-0	Silver			
	-	-			
	-	-			
11	#-1971820-1	Tin		See table 2	(See fig 2)
	#-1971840-1	Silver			
	-	-			
	-	-			
12	#-1971820-2	Tin		See table 2	(See fig 2)
	#-1971840-2	Silver			
	-	-			
	-	-			
13	#-1971820-3	Tin		See table 2	(See fig 2)
	#-1971840-3	Silver			
	-	-			
	-	-			

Fully Loaded, Internal Locking

Position	Part Number	Tab Contact Plating	Keying And Locking Latch	Color	Pcb Lay Out
14	#-1971820-4	Tin	 I-1971820-4 I-1971840-4	See table 2	(See fig 2)
	#-1971840-4	Silver			
	-	-			
	-	-			
15	#-1971820-5	Tin	 I-1971820-5 I-1971840-5	See table 2	(See fig 2)
	#-1971840-5	Silver			
	-	-			
	-	-			

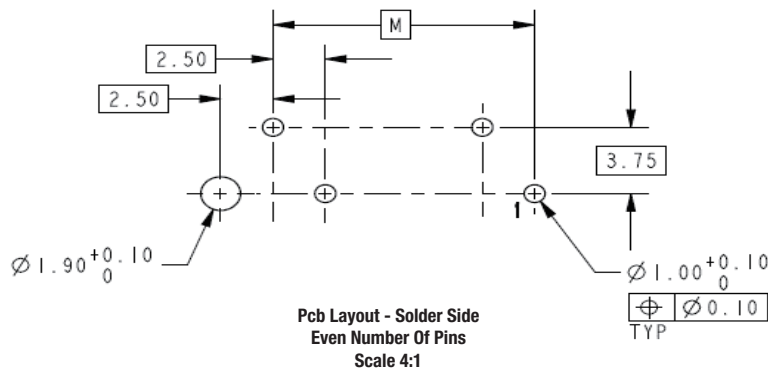
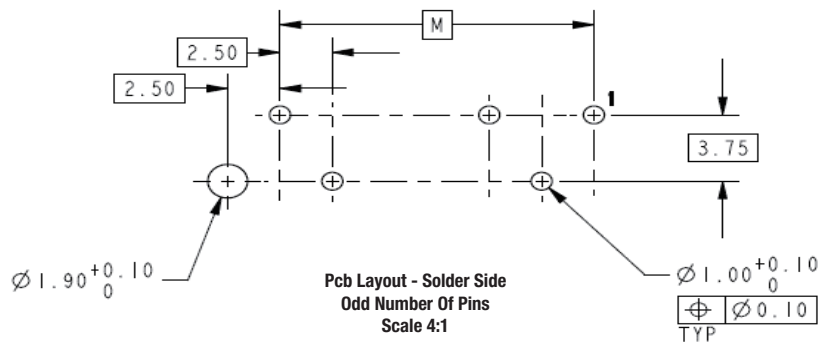

Fig 2

35.00	15
32.50	14
30.00	13
27.50	12
25.00	11
22.50	10
20.00	9
17.50	8
15.00	7
12.50	6
10.00	5
7.50	4
5.00	3
M	NO. OF POS.

Fully Loaded, Internal Locking

Table 2

Color	With Tin Plating Contact		With Silver Plating Contact		Comments
Natural	#-1971819-#	#-1971820-#	#-1971839-#	#-1971840-#	
Red	#-2232161-#	#-2232162-#	#-2232163-#	#-2232164-#	
Blue	#-2232165-#	#-2232166-#	#-2232167-#	#-2232168-#	
Yellow	#-2232169-#	#-2232170-#	#-2232171-#	#-2232172-#	
Black	#-2232173-#	#-2232174-#	#-2232175-#	#-2232176-#	
Grey	#-2232177-#	#-2232178-#	#-2232179-#	#-2232180-#	
Green	#-2232181-#	#-2232182-#	#-2232183-#	#-2232184-#	
Purple	#-2232185-#	#-2232186-#	#-2232187-#	#-2232188-#	
White	#-2232289-#	#-2232291-#	#-2232290-#	#-2232292-#	

The Prefix And Postfix Are The Same With The P/N Of The Natural Tab Header For The Same Keying Configuration, Just The Base Numbers Are Different Based On Different Color. * And # Can Be The Number From 0 To 9.

For Any Keying Configuration, There Are Eight Colors Available, Besides The Natural Color, There Are Other Seven Colors, Include: Yellow, Blue, Grey, Purple, Red, Green, Black. The P/n of The Color Tab Header Are Based On The Natural Tab Header, The Prefix And Postfix Are The Same For The Same Keying Configuration, But The Base Numbers Are Different According To Different Color. the Following Shows What's The P/n For Color Tab Header. The Related P/n of The Housing For The Color Tab Header Are Also Based On The Natural Housing, Only The Base Number Is Different.

Selectively Loaded, External Locking

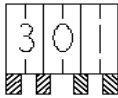
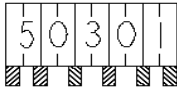
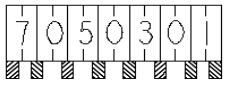
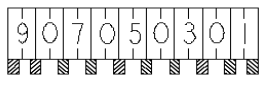
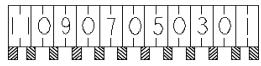
Position	Part Number	Tab Contact Plating	Keying And Locking Latch	Color	Pcb Lay Out
General	#-1971921-#	Tin	-	-	(See Fig 3)
	#-1971923-#	Silver			
	#-1971922-#	Tin			
	#-1971924-#	Silver			
3	#-1971921-3	Tin	 I - 1971921-3 I - 1971923-3	See table 3	(See fig 3)
	#-1971923-3	Silver			
	-	-			
	-	-			
5	#-1971921-5	Tin	 I - 1971921-5 I - 1971923-5	See table 3	(See fig 3)
	#-1971923-5	Silver			
	-	-			
	-	-			
7	#-1971921-7	Tin	 I - 1971921-7 I - 1971923-7 ⁵	See table 3	(See fig 3)
	#-1971923-7	Silver			
	-	-			
	-	-			
9	#-1971921-9	Tin	 I - 1971921-9 I - 1971923-9 ⁵	See table 3	(See fig 3)
	#-1971923-9	Silver			
	-	-			
	-	-			
11	#-1971922-1	Tin	 I - 1971922-1 I - 1971924-1 ⁵	See table 3	(See fig 3)
	#-1971924-1	Silver			
	-	-			
	-	-			



Selectively Loaded, External Locking

Position	Part Number	Tab Contact Plating	Keying And Locking Latch	Color	Pcb Lay Out
13	#-1971922-3	Tin		See table 3	(See fig 3)
	#-1971924-3	Silver			
	-	-			
	-	-			
15	#-1971922-5	Tin		See table 3	(See fig 3)
	#-1971924-5	Silver			
	-	-			
	-	-			

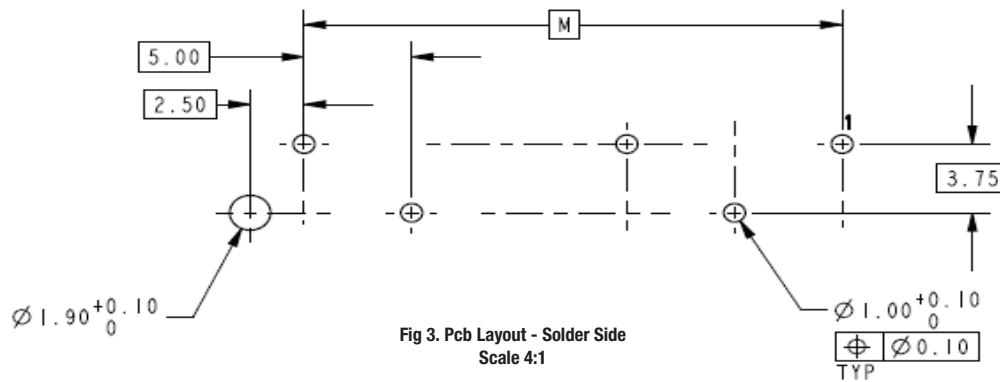

Fig 3. Pcb Layout - Solder Side
Scale 4:1

35.00	8 LOAD, 15 POS.
30.00	7 LOAD, 13 POS.
25.00	6 LOAD, 11 POS.
20.00	5 LOAD, 9 POS.
15.00	4 LOAD, 7 POS.
10.00	3 LOAD, 5 POS.
5.00	2 LOAD, 3 POS.
M	No. of Pos.

Selectively Loaded, External Locking

Table 3

Color	With Tin Plating Contact		With Silver Plating Contact		Comments
Natural	#-1971921-#	#-1971922-#	#-1971923-#	#-1971924-#	
Red	#-2232189-#	#-2232190-#	#-2232191-#	#-2232192-#	
Blue	#-1971984-#	#-1971985-#	#-2232193-#	#-2232194-#	
Yellow	#-2232195-#	#-2232196-#	#-2232197-#	#-2232198-#	
Black	#-2232199-#	#-2232200-#	#-2232201-#	#-2232202-#	
Grey	#-2232203-#	#-2232204-#	#-2232205-#	#-2232206-#	
Green	#-2232207-#	#-2232208-#	#-2232209-#	#-2232210-#	
Purple	#-2232211-#	#-2232212-#	#-2232213-#	#-2232214-#	
White	#-2232289-#	#-2232291-#	#-2232290-#	#-2232292-#	

The Prefix And Postfix Are The Same With The P/N Of The Natural Tab Header For The Same Keying Configuration, Just The Base Numbers Are Different Based On Different Color. * And # Can Be The Number From 0 To 9.

For Any Keying Configuration, There Are Eight Colors Available, Besides The Natural Color, There Are Other Seven Colors, Include: Yellow, Blue, Grey, Purple, Red, Green, Black. The P/n of The Color Tab Header Are Based On The Natural Tab Header, The Prefix And Postfix Are The Same For The Same Keying Configuration, But The Base Numbers Are Different According To Different Color. the Following Shows What's The P/n For Color Tab Header. The Related P/n of The Housing For The Color Tab Header Are Also Based On The Natural Housing, Only The Base Number Is Different.



Applicators

OCEAN Applicator Series

Crimping standards continue to rise to higher levels of quality and repeatability. Taking customer input and market demands into consideration, TE application tooling has created the OCEAN applicator series to meet those higher demands and to take terminal crimping to a new level. By consolidating our applicator offering, TE can provide design consistency and tooling standardization to the market.

One of the resulting benefits to customers of this consolidation is flexibility in the choice of feeding options: new and improved mechanical and pneumatic feeds along with the innovative and precise servo feed option. The OCEAN applicator series design also allows customers to perform field upgrades to system III technology. It provides an upgrade path for terminal intelligence that allows the machine to obtain set up features as the applicator is upgraded.

- One applicator platform – modular family design
- Two ram interface styles
- Three interchangeable feed options

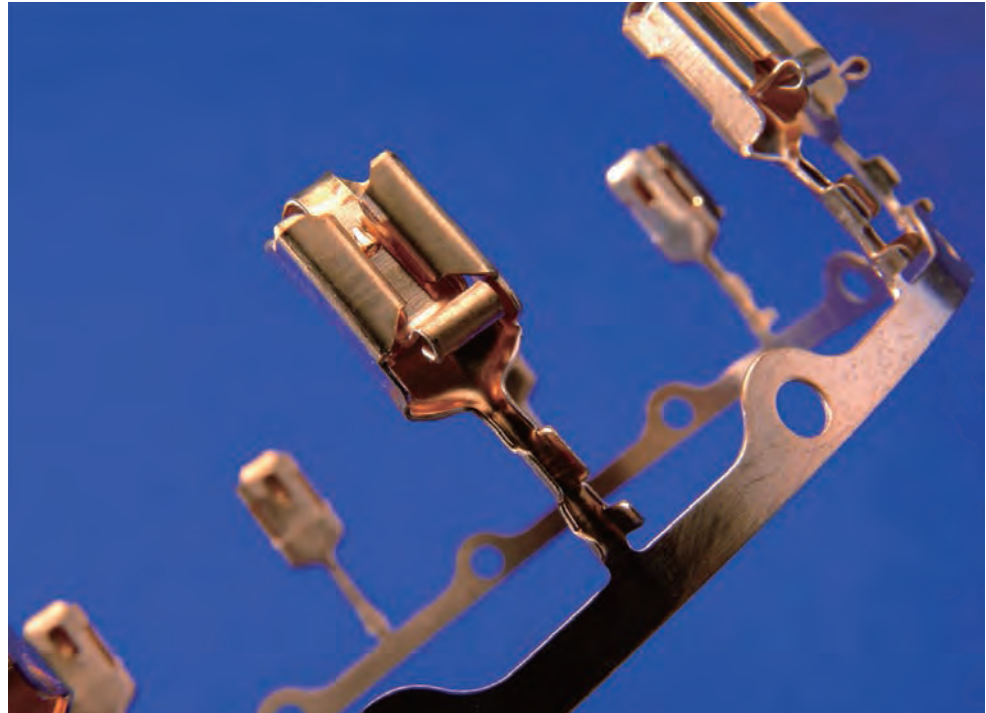

Mechanical Feed

The new mechanical feed design has a 50% faster setup and service and a single tool adjustment. Unlike the HDI or the competitive applicators, the feed cam and cam follower remain in constant contact to offer superior feeding performance.

Pneumatic Feed

Unlike the competition, the OCEAN pneumatic feed has independent forward and back stroke settings. If only a forward adjustment is needed the terminal can be advanced by as little as 0.04 mm without touching the back stroke setting.

Servo Feed

Improved feed accuracy and repeatability help to improve spare part life. Motorized feed allows for slow, controlled, and accurate terminal placement repeatability. This is done without slowing the speed of the machine.



IDC Bench-Top for AMP DUOPLUG 2.5

Bench Machine for AMP DUOPLUG 2.5 Connectors

TE offers the IDC semi-automatic bench machine that applies AMP DUOPLUG 2.5 connectors (application specification 114-18049) which are widely used within the household appliance industry. The connectors are delivered on trays. Depending on the machine version the tray feeding can either be manually or automatically. Both machine versions with manual or automatic tray feed can be equipped with keying rib test and/or wire insertion length test as an option. The testing stations help to detect badly terminated connections and/or badly keyed connectors.

In case of a bad detected connector/connection the IDC bench top machine gives the operator a clear text message and instead of closing the cover, the machine waits for the operator to remove the unclosed connector by hand. The operator may have to remove a complete sequence even if only one bad connector/connection has been detected.



- Termination of single wires to AMP DUOPLUG 2.5 IDC connectors
- The connectors are loaded either semi-automatically or automatically from the tray. The image shows a machine version with automatic feed.
- Testing stations are available optionally. They help to ensure termination quality according to the respective specification.

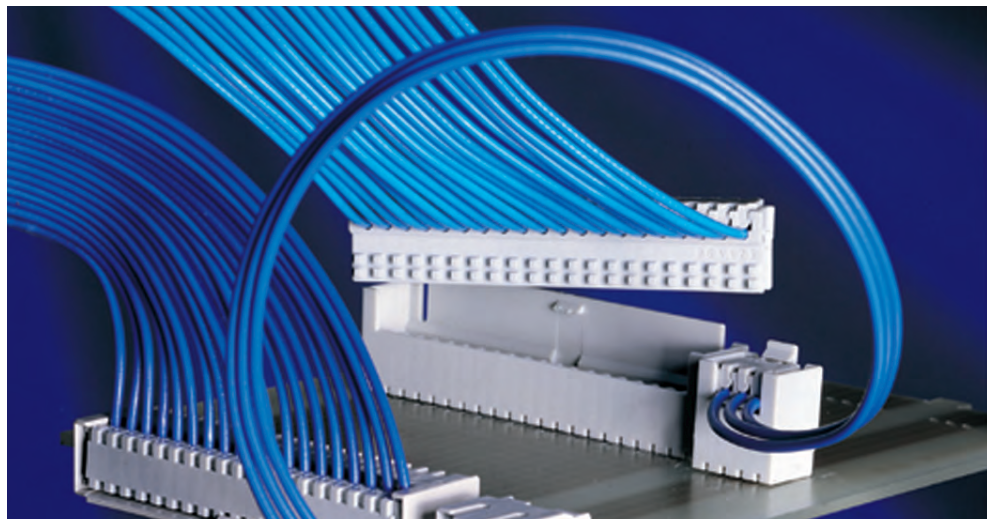

Workstations for FHM IDC Flexible Harness Maker

**SIM 50E / 52E / 25E / 26E
Modular IDC Workstations**

These semi-automatic machines have been designed to apply all TE Connectivity RAST 2.5 and RAST 5 connectors used within the household appliance industry. The machines are configured as base machines which can be extended through a variety of production enhancing options. The machines configurability leads to an economical and application specific solution.

Connectors are separated automatically within the machine. Key cutting and checking are all automatic processes. The wires are inserted one by one manually and the machine controls the wire insertion length automatically. Any rejects are separated automatically. One sequence can contain up to 12 positions in a 5 mm pitch or up to 23 positions in a 2.5 mm pitch. The SIM economy series are designed to be used either with the FHM IDC fully-automatic machine or as stand alone machines.



Mechanical Feed

- Automatic product feeding
- Latch-cutting and separation
- Key cutting and checking
- Wire termination
- Wire length checking
- Cover closing
- Good bad sorting
- Simple and ergonomic operator interface with touch screen control

Available options

- Active wire clamping
- Electrical continuity test
- Wire bending (not for SIM 25E)
- Cover marking
- Conversion kit for AMP DUOPLUG 2.5 Mark II (only for SIM 25E)
- Conversion kit for AMP DUOPLUG power connector (only for SIM 25E)
- Conversion kit FHM IDC machine
- Modem remote maintenance

These machines are compatible with following IDC connector systems:

- AMP DUOPLUG 2.5
- AMP DUOPLUG 2.5 Mark II
- AMP DUOPLUG Power
- AMP multifitting Mark II
- AMP MONO-SHAPE

SIM Compact; semi automatic machine

SIM Compact semi automatic machine for RAST IDC connection SIM 25C / SIM 50C / SIM 52C

Both the SIM (Semi Automatic IDC Machine) 25C and SIM 50C are compact semi-automatic stand-alone bench machines for processing RAST connectors which are widely used within the household appliance industry. They are a cost-effective alternative to the SIM E machines with better labor utilization and comparable functionality at the same time.

SIM Compact is designed for following connector systems.

SIM 25C: AMP DUOPLUG 2.5 Mark II and/or AMP DUOPLUG power connector

SIM 50C: AMP multifitting Mark II

SIM 52C: AMP MONO-SHAPE



These machines separate the foremost connectors from the inlaid chains, cut the latches and position the connectors for termination. The wires are placed into the machine manually by the operator, the machine will then check the wire insertion length, separate the cover from the

connector and place them into the housing, cut the coding-ribs in accordance with the input coding and present the finished connectors for removal by the operator via the outfeed.

The machines can be loaded with up to 2 chained connectors with different numbers of positions into

one sequence. All required data input can be done conveniently over a 4 inch color touch screen.

- Compact stand-alone machines for single wire IDC termination
- Cost-effective base machines for market entrance into RAST IDC connector business with medium labor utilization
- User-friendly human machine interface

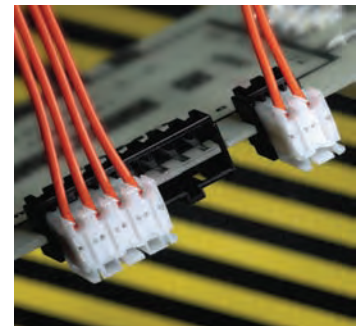

IDC Harness Makers - FHM

FHM IDC Flexible Harness Maker

The FHM (Flexible Harness Maker) IDC is a fully-automatic machine for cost effective harness production. Used in conjunction with our well known interchangeable SIM XX E work stations, it is able to process RAST 2.5 and RAST 5 connector systems at the same time, specifically designed for the household appliance market.

The machine excels in the flexibility it offers. It is capable of processing cross sections in a range from 0.22– 1.5 mm². The wire selector allows as standard to have 6 different wires loaded.

This modular designed fully-automatic machine is capable of producing IDC Charnesses, featuring, apart from parallel wiring, also crossovers and bridges.

It is specifically designed to meet customer's demands for minimal set up and changeover times, while providing high output including various quality assurance checks.

The following harnesses can be manufactured:

- Parallel designs
- Crossovers
- Bridges
- Loose end connections
- Connections with varying wire lengths and sizes.



Flexible Harness Maker-IDC consists of:

- FHM IDC base machine with operating interface via touch screen
- Servo controlled transport gripper system
- Possibility to run with one or two SIM E Workstations
- Universal wire selector up to 12 positions, prepared for 6 wires

Both, RAST 5 and RAST 2.5 connectors can be processed simultaneously with all of these options, depending on the SIM workstation.

Applicable semi-automatic IDC Machines economy or flexible Versions and Connectors:

- SIM 25 E for AMP DUOPLUG 2.5 Mark II and AMP DUOPLUG power connector
- SIM 26 E for AMP DUOPLUG 2.5
- SIM 50 E for AMP multifitting Mark II
- SIM 52 E for AMP MONO-SHAPE



IDC Harness Makers - IHM Mark III

**IHM Mark III Fully Automatic
IDC Mass Termination
Machine**

The IHM Mark III is a flexible high performance fully automatic machine for mass jumper production. Interchangeable IDC workstations ensure the processing for different IDC connector systems within short set up time.

The complete manufacturing process includes

- Multiple wire feeding (up to 21 different wires)
- Connector loading (2.5 mm and 5.0 mm pitch)
- Mass termination of the wires
- Connector polarization and key cutting
- Quality control
- Cover closing and colour marking

The quality control system is integrated in the IDC connector stations and includes both insertion length and electrical continuity testing.



- Modular processing equipment with interchangeable IDC stations
- Possibility to process 2.5 mm and 5.0 mm pitch in the same harness
- Extremely high output for processing up to 21 parallel wires in mass termination
- Very low set up times thanks to the fully modular design of the machine
- Each connector processing module is fully independent and contains all the process features necessary for the particular product (i.e. polarization/cover closing etc.)
- Easy maintenance
- Production assistance and trouble shooting via modem
- Simple and ergonomic operator interface with touch screen control



Available IDC Workstations for following connector systems:

- AMP DUOPLUG 2.5
- AMP DUOPLUG 2.5 Mark II and/or AMP DUOPLUG Power
- AMP multifitting Mark II
- AMP MONO-SHAPE

Engineering Notes



This page has been intentionally left blank

LET'S CONNECT

We make it easy to connect with our experts and are ready to provide all the support you need. Just call your local support number or visit www.te.com/appliances to chat with a Product Information Specialist.

Technical Support

te.com/support-center

Australia	+86 400-820-6015	Hungary	+36 1-2892040	Portugal	+34 91-6630420
Austria	+43 1-9056-0	India	+86 400-820-6015	Russia	+74 95-790-790-2200
Belgium	+31 73-6246999	Ireland	+1 800-882-391	Slovakia	+42 02-720-11102
Brazil	+55 11-2103-6000	Italy	+39 011-4012111	Slovenia	+38 615-602-132
China	+86 400-820-6015	Japan	+044-844-8052	South Africa	+97 150-457-0806
Czech Republic	+42 02-7201-1103	Korea	+02-3415-4607	Spain	+34 932-910-330
Denmark	+46 8-5072-5000	Latvia	+37 2-6778-673	Sweden	+46 8-5072-5000
Estonia	+37 2677-8673	Lithuania	+37 037426900	Switzerland	+41 71-447-0447
Finland	+46 8-5072-5000	Luxembourg	+31 73-6246999	Taiwan	+86 400-820-6015
France	+33 1-34-20-8686	Netherlands	+31 73-6246999	Turkey	+90 212-282-6053
Germany	+49 6151-607-1999	New Zealand	+86 400-820-6015	United Kingdom	+44 0800-267666
Greece	+97 1-4-347-0226	Norway	+46 8-5072-5000	United States of America	800-522-6752
Holland	+31 73-6246999	Poland	+48 22-4576750		

te.com/appliances

© 2014 TE Connectivity Ltd. family of companies. All Rights Reserved.

1-1773727-3 APP PDF 02/2016

TE Connectivity, TE connectivity (logo), Every Connection Counts, AMP, AMP DUOPLUG, AMP DUOPLUG 2.5, AMP MONO-SHAPE, FASTIN-FASTON, OCEAN and Positive Lock are trademarks.

Other logos, product and/or company names might be trademarks of their respective owners.

While TE has made every reasonable effort to ensure the accuracy of the information in this catalog, TE does not guarantee that it is error-free, nor does TE make any other representation, warranty or guarantee that the information is accurate, correct, reliable or current. TE reserves the right to make any adjustments to the information contained herein at any time without notice. TE expressly disclaims all implied warranties regarding the information contained herein, including, but not limited to, any implied warranties of merchantability or fitness for a particular purpose. The dimensions in this catalog are for reference purposes only and are subject to change without notice. All specifications are subject to change without notice. Consult TE for the latest dimensions and design specifications.