

48128 ✓ 有效

AMP

TE 内部编号 48128

Hand Crimping Tools, Premium Crimp Tooling, Removable /Interchangeable, MIL Spec / TE Product Specification (114-), Battery / Manual / Hydraulic

[在 TE 官网查看>](#)



应用工具 > 手动压接工具

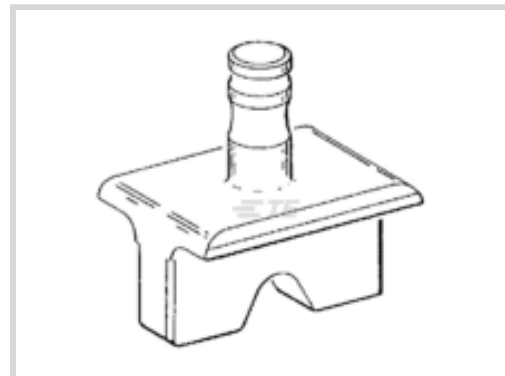

工具等级: 高级压接工具

模具组类型: 可拆卸/可互换

规范类型: TE 产品规格 (114-), 军用规范

TE 认证: 无法认证

电源技术类型: 手动, 液压, 电池

产品特性

其他

压接形式-压线筒类型	闭式压线筒 - W 压接
工具等级	高级压接工具
模具组类型	可拆卸/可互换
规范类型	TE 产品规格 (114-), 军用规范
TE 认证	无法认证
电源技术类型	手动, 液压, 电池
工具类型	模具总成

产品合规性

[如需合规文档，请访问 TE 官网产品页面。>](#)

欧盟RoHS指令2011/65/EU	不在合规性范围内
欧盟ELV指令2000/53/EC	不在合规性范围内
中国电器电子产品有害物质限制使用管理办法（China RoHS 2，工业和信息化部携七部委2016年第32号令	未针对中国 RoHS 符合性进行审核
欧盟REACH法规(EC) No. 1907/2006	欧洲化学品管理局最新发布的SVHC候选清单: 2024年1月 (240) SVHC候选清单的声明更新至: 2024年1月 (240) 不含REACH SVHC
卤素含量	低卤素 - 每种匀质材料的 Br、Cl、F、I <

900 ppm。也不含 BFR/CFR/PVC













焊接工艺能力

不适合采用焊接工艺

产品合规免责声明

此信息基于对供应商的合理调查以及TE对供应商提供的信息的现有认知。此信息可能发生变化。经TE确认符合欧盟RoHS的产品编号，产品均质材料中铅、六价铬、汞、PBB、PBDE、DEHP、BBP、DBP和DIBP的最大浓度不超过0.1%，镉的最大浓度不超过0.01%或符合指令2011/65/EU(RoHS2)及其修订指令规定的豁免。根据2011/65/EU指令要求电子电气产品需要进行CE标识。元器件产品通常无需进行CE标识。经TE确认符合欧盟ELV指令的产品编号，产品均质材料中，铅、六价铬和汞的最大浓度不超过0.1%，镉的最大浓度不超过0.01%（按重量计算），或符合指令2000/53/EC(ELV)附录中规定的豁免。关于欧盟REACH法规，TE目前提供的此产品编号的物品中高度关注物质(SVHC)的信息是基于欧洲化学品管理局(ECHA)最新发布的“物品中物质的要求指南”，链接如下：<https://echa.europa.eu/guidance-documents/guidance-on-reach>

配套部件

 <p>TE 产品编号 36809 TERMINAL,SOLIS R 6 5/8</p>	 <p>TE 产品编号 323171 TERMINAL,SOLIS R HR 6 5/16</p>	 <p>TE 产品编号 36808 TERMINAL,SOLIS R 6 1/2</p>	 <p>TE 产品编号 320344 TERMINAL,SOLIS R 6 1/2</p>
 <p>TE 产品编号 130552 TERM, RING, SOLIS, 6, M5</p>	 <p>TE 产品编号 323174 TERMINAL,SOLIS R HR 4 5/16</p>	 <p>TE 产品编号 323172 TERM, STRAT, SOLIS, RT, HR, 6, 3/8</p>	 <p>TE 产品编号 36886 SPLICE,SOLIS BUTT 6</p>
 <p>TE 产品编号 52197 TERMINAL,SOLIS R 6 10</p>	 <p>TE 产品编号 33467 TERMINAL,SOLIS R 6 3/8</p>	 <p>TE 产品编号 34322 SPLICE,SOLIS BUTT 6</p>	 <p>TE 产品编号 33465 TERMINAL,SOLIS R 6 1/4</p>



客户还购买了



文档



数据表/目录页

[AT-Hydraulic Crimp Tooling Solutions-1654519](#)

英文版本

Bottoming Dies

英文版本

使用说明书

[使用说明书 \(美国\)](#)

英文版本