

284844-6  请勿在新设计中使用

AMP MCP 1.5K, AMP MCP 2.8, AMP MCP Connector System

TE 内部编号 284844-6

TE 内部产品描述 12 POS MCP HYBRID MALE CONNECTOR

SEALED

AMP MCP，密封连接器壳体

[在 TE 官网查看>](#)

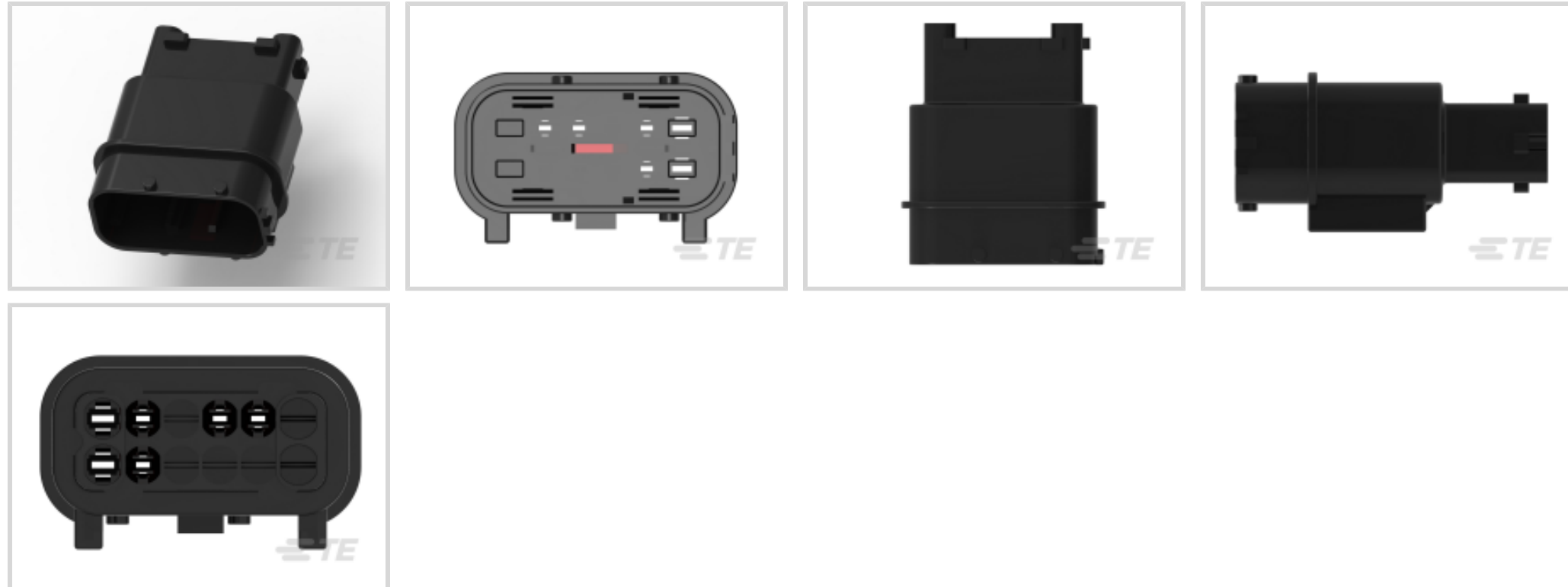

[所有 AMP MCP，密封连接器壳体 \(160\)](#)

## 产品合规性

[如需合规文档，请访问 TE 官网产品页面。>](#)

欧盟RoHS指令2011/65/EU	符合
欧盟ELV指令2000/53/EC	符合
中国电器电子产品有害物质限制使用管理办法（China RoHS 2，工业和信息化部携七部委2016年第32号令	没有超出阈值的受限材料
欧盟REACH法规(EC) No. 1907/2006	欧洲化学品管理局最新发布的SVHC候选清单: 2024年1月 (240) SVHC候选清单的声明更新至: 2024年1月 (240) 不含REACH SVHC
卤素含量	低卤素 - 每种均质材料的 Br、Cl、F、I < 900 ppm。也不含 BFR/CFR/PVC
焊接工艺能力	不适合采用焊接工艺

### 产品合规免责声明

此信息基于对供应商的合理调查以及TE对供应商提供的信息的现有认知。此信息可能发生变化。经TE确认符合欧盟RoHS的产品编号，产品均质材料中铅、六价铬、汞、PBB、PBDE、DEHP、BBP、DBP和DIBP的最大浓度不超过0.1%，镉的最大浓度不超过0.01%或符合指令2011/65/EU(RoHS2)及其修订指令规定的豁免。根据2011/65/EU指令要求电子电气产品需要进行CE标识。元器件产品通常无需进行CE标识。经TE确认符合欧盟ELV指令的产品编号，产品均质材料中，铅、六价铬和汞的最大浓度不超过0.1%，镉的最大浓度不超过0.01%（按重量计算），或符合指令2000/53/EC(ELV)附录中规定的豁免。关于欧盟REACH法规，TE目前提供的此产品编号的物品中高度关注物质(SVHC)的信息是基于欧洲化学品管理局(ECHA)最新发布的“物品中物质的要求指南”，链接如下：<https://echa.europa.eu/guidance-documents/guidance-on-reach>

## 配套部件

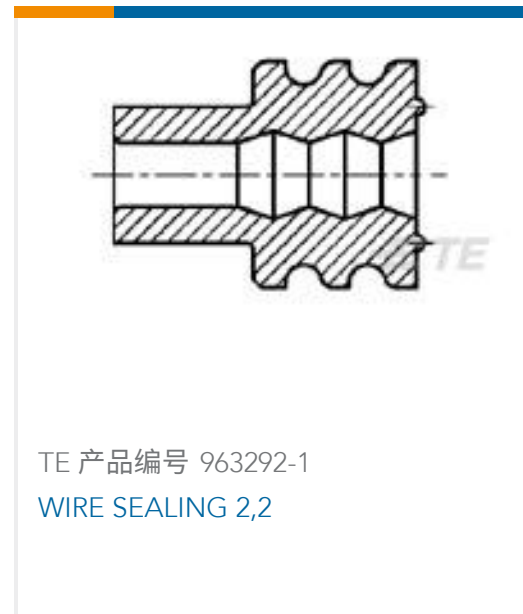

### 该系列中的其他产品 | AMP MCP 1.5K



### 该系列中的其他产品 | AMP MCP 2.8

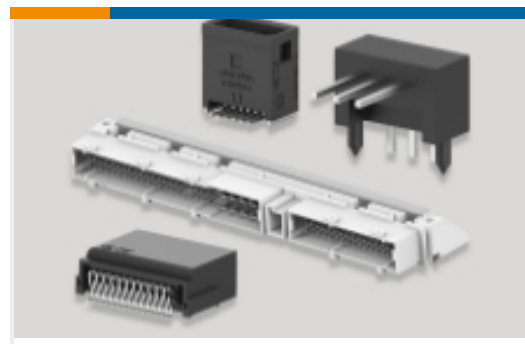

PCB 板端连接器及母端(1)



插入和拔出工具(6)

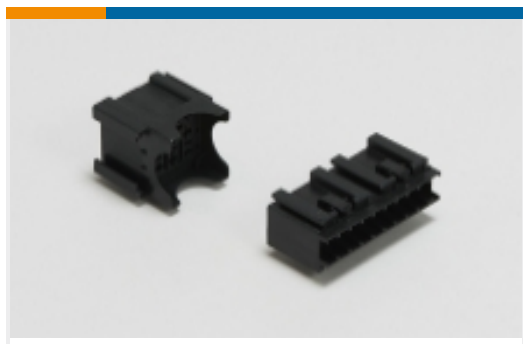

模块元件(1)

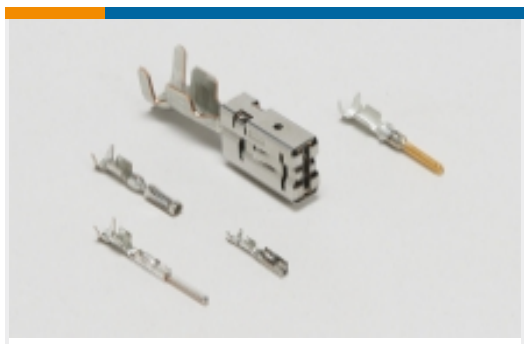

汽车端子(10)



汽车连接器护套(164)



汽车连接器盖帽(1)

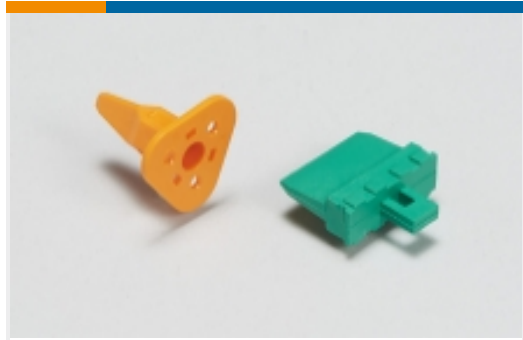

汽车连接器锁和位置保证(5)



连接器密封件和盲堵(1)

### 该系列中的其他产品 | AMP MCP Connector System

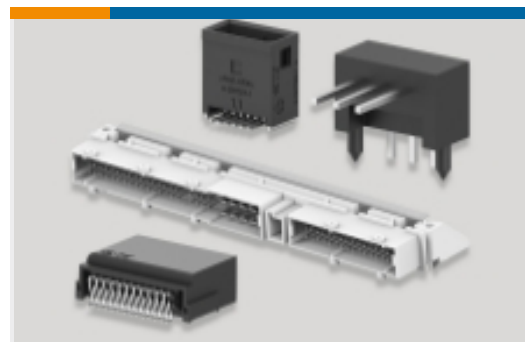

PCB 板端连接器及母端(28)



其他汽车连接器附件(2)



插入和拔出工具(13)



汽车端子(129)



汽车连接器护套(329)



汽车连接器盖帽(23)

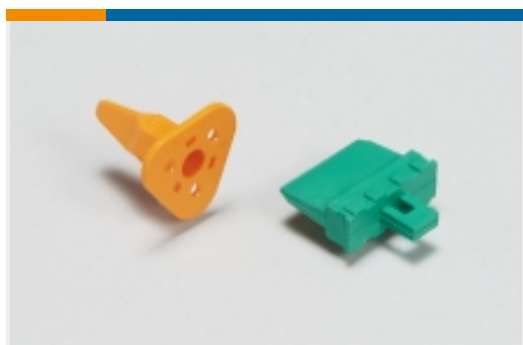

汽车连接器锁和位置保证(6)



连接器密封件和盲堵(7)

### 客户还购买了



## 文档

### 产品图纸

#### 12 POS MCP HYBRID MALE CONNECTOR SEALED

英文版本

### CAD 文件

3D PDF

3D

下载查看

[ENG\\_CVM\\_CVM\\_284844-6\\_D.2d\\_dxf.zip](#)

英文版本

下载查看

[ENG\\_CVM\\_CVM\\_284844-6\\_D.3d\\_igs.zip](#)

英文版本

下载查看

[ENG\\_CVM\\_CVM\\_284844-6\\_D.3d\\_stp.zip](#)

英文版本

下载CAD文件代表我接受和同意[使用条款](#)。

### 产品规格

产品规格

英文版本

### 使用说明书

使用说明书 (非美国)

英文版本