

The PT8DN, using a high cycle plastic-hybrid potentiometer, communicates via DeviceNET protocol with programmable controllers in factories and harsh environments requiring linear position measurements in ranges up to 60".

As a member of our innovative family of NEMA 4 rated cable actuated sensors, the PT8DN installs in minutes by simply mounting its body to a fixed surface and attaching its cable to the movable object. Perfect parallel alignment not required.

#### Output Signal

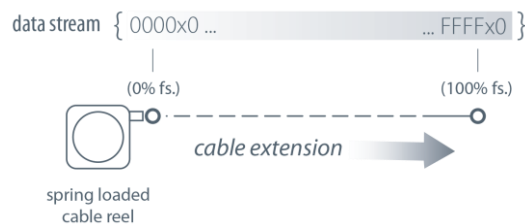

## PT8DN

### Cable Actuated Sensor Heavy Industrial DeviceNET® Communication

#### Industrial Grade String Pot

**Absolute Linear Position to 60 inches (1524 mm)**

**Aluminum or Stainless Steel Enclosure Options**

**NEMA 6 / IP67**

#### General

<b>Full Stroke Ranges</b>	0-2 to 0-60 inches
<b>Electrical Interface</b>	CANbus ISO 11898
<b>Protocol</b>	DeviceNET version 2.0
<b>Accuracy</b>	± 1.0% to ± 0.1% full stroke (see ordering information)
<b>Repeatability</b>	± 0.02% full stroke
<b>Resolution</b>	± 0.003% full stroke
<b>Measuring Cable</b>	stainless steel, nylon-coated or thermoplastic
<b>Enclosure Material</b>	powder-painted aluminum or stainless steel
<b>Sensor</b>	plastic-hybrid precision potentiometer
<b>Potentiometer Cycle Life</b>	see ordering information
<b>Maximum Retraction</b>	see ordering information
<b>Acceleration</b>	
<b>Weight, Aluminum (Stainless Steel) Enclosure</b>	3 lbs. (6 lbs.), max.

#### Electrical

<b>Input Voltage</b>	bus powered
<b>Input Current</b>	40 mA
<b>Address Setting/Node ID</b>	0...63 set via DIP switches (default: 63)
<b>Baud Rate</b>	125K, 250K or 500K set via DIP switches
<b>EDS File</b>	available @ <a href="http://www.celeso.com/download">http://www.celeso.com/download</a>

#### Environmental

<b>Environmental Suitability</b>	NEMA 4X/6, IP 67
<b>Operating Temperature</b>	-40° to 185°F (-40° to 85°C)
<b>Vibration</b>	up to 10 g to 2000 Hz maximum

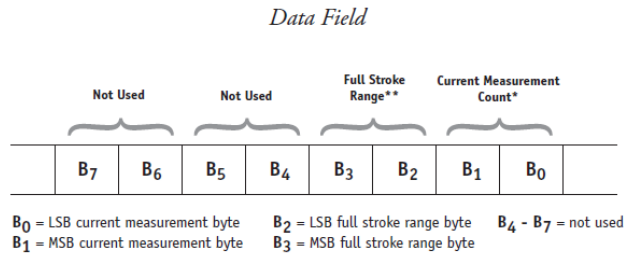
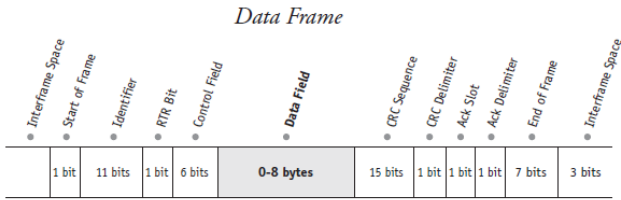

**\*Current Measurement Count**

The Current Measurement Count (CMC) is the output data that indicates the present position of the measuring cable.

The CMC is a 16-bit value that occupies the first two bytes (B<sub>0</sub> and B<sub>1</sub>) of the data field. B<sub>0</sub> is the LSB (least significant byte) and B<sub>1</sub> is the MSB (most significant byte).

The CMC starts at 0000H with the measuring cable fully retracted and continues upward to the end of the stroke range stopping at FFFFH. This holds true for all ranges.

**\*\*Full Stroke Range**

The Full Stroke Range (FSR) is a 16-bit value in the data field that expresses the full range of the sensor in inches. This value can be used to convert the actual count to units of measurement should the application require it.

The full stroke measurement range occupies the second two bytes (B<sub>2</sub> and B<sub>3</sub>) of the data field.

B<sub>2</sub> is the LSB (least significant byte) and B<sub>3</sub> is the MSB (most significant byte).

This value is expressed in inches.

Example:

Hex Value	Decimal Equivalent	Full Stroke Range
001E	30	30 inches

**Converting CMC to Inches**

If required, the CMC can easily be converted to a linear measurement expressed in inches instead of just counts.

This is accomplished by first dividing the CMC by 65,535 (total counts over the range) and then multiplying that value by the FSR:

$$\left( \frac{\text{CMC}}{65,535} \right) \times \text{FSR}$$

Example:

If the full stroke range is 30 inches and the current position is OFF2 Hex (4082 Decimal) then,

$$\left( \frac{4082}{65,535} \right) \times 30.00 \text{ inches} = 1.87 \text{ inches}$$

**Address Setting (Node ID), Baud Rate and Bus Termination Settings**

**Address Setting (Node ID)**

The Address Setting (Node ID) is set via 6 switches located on the 8-pole DIP switch found on the DeviceNET controller board located inside the transducer.

The DIP switch settings are binary starting with switch number 1 (= 2<sup>0</sup>) and ending with switch number 6 (= 2<sup>5</sup>).

DIP-1 (2 <sup>0</sup> )	DIP-2 (2 <sup>1</sup> )	DIP-3 (2 <sup>2</sup> )	DIP-4 (2 <sup>3</sup> )	DIP-5 (2 <sup>4</sup> )	DIP-6 (2 <sup>5</sup> )	address (decimal)
0	0	0	0	0	0	0
1	0	0	0	0	0	1
0	1	0	0	0	0	2
...	...	...	...	...	...	...
1	1	1	1	1	1	63



**Baud Rate**

The transmission baud rate may be either factory preset at the time of order or set manually at the time of installation.

The baud rate can be set using switches 7 & 8 on the 8-pole DIP switch found on the DeviceNET controller board located inside the transducer.

DIP-7	DIP-8	baud rate
0	0	125k
1	0	250k
0	1	500k
1	1	125k



**Bus Termination**

The setting of the internal bus termination resistor may be specified upon order or manually changed by the end user at the time of installation.

The bus termination resistor is activated setting switches 1 & 2 on the 2-pole DIP switch (located on the internal DeviceNET controller board) to the "ON" position.

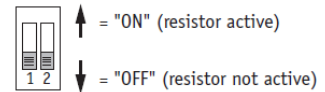

**DeviceNET Controller Board and DIP Switch Location**

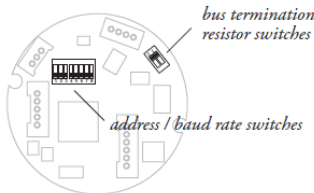

to gain access to the controller board, remove four Allen-Head Screws and remove rear cover

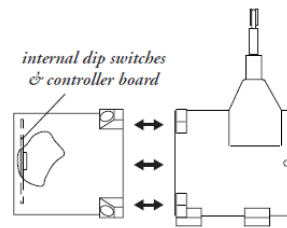

# PT8DN

Heavy Industrial • DeviceNET® Communication

## Outline Drawing

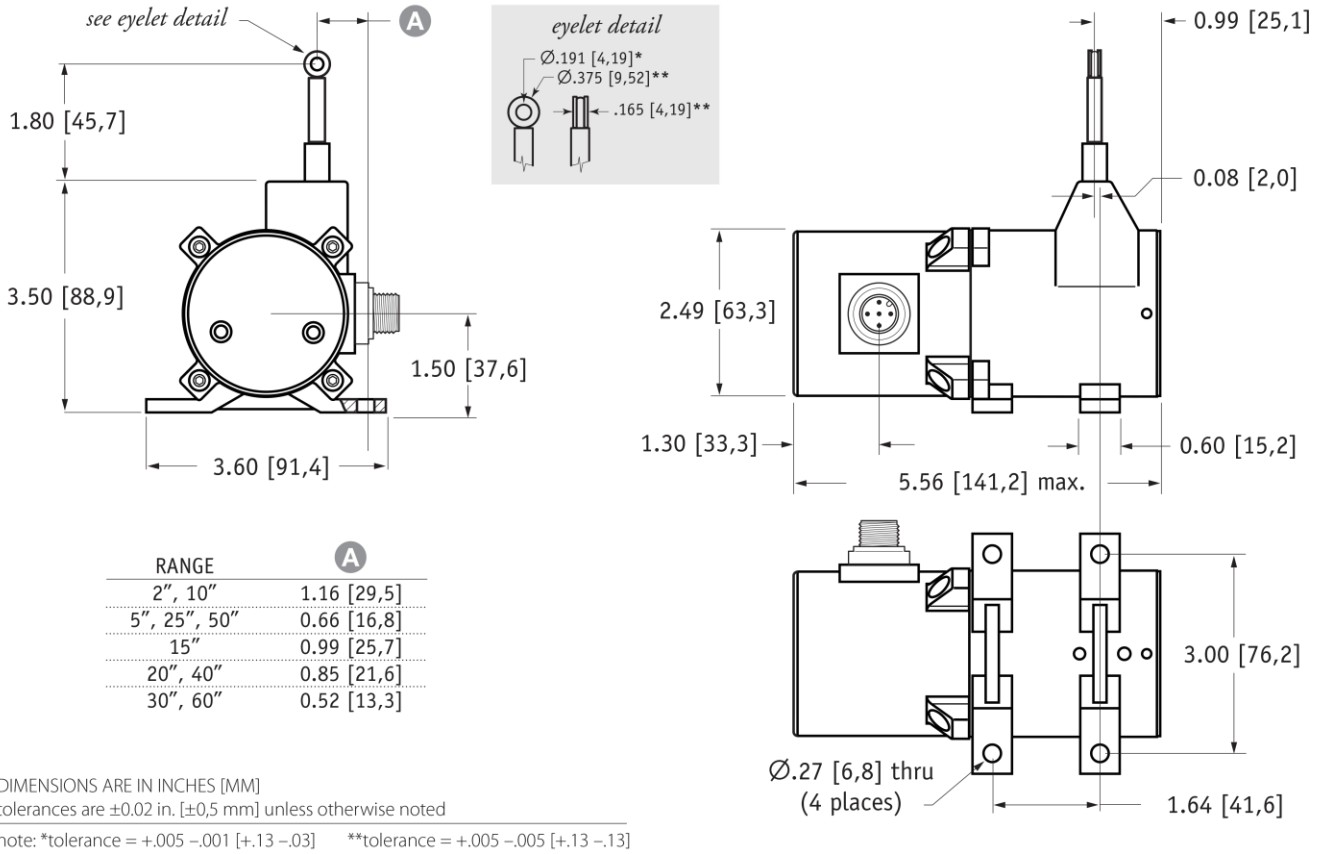

## Ordering Information

### Model Number:

**PT8DN** -                                        

*order code:*                      **R**        **A**        **B**        **C**        **D**        **E**        **F**        **G**

Sample Model Number:

**PT8DN - 50ALN34T1CG - 500TRSC5**

- R** range: 50 (50 inches)
- A** enclosure: AL (aluminum)
- B** measuring cable: N34 (.034 nylon-coated stainless)
- C** measuring cable tension: T1 (standard)
- D** cable guide: CG (standard)
- E** baud rate: 500 (500k bits/sec.)
- F** terminating resistor: TR (with terminating resistor)
- G** electrical connection: SC5 (5-meter cordset with straight plug)

### Full Stroke Range:

<b>R</b> order code:	2	5	10	15	20	25	30	40	50	60
full stroke range, min:	2 in.	5 in.	10 in.	15 in.	20 in.	25 in.	30 in.	40 in.	50	60
accuracy (% of f.s.):	1.00%	1.00%	0.15%	0.15%	0.15%	0.15%	0.15%	0.10%	0.10%	0.10%
potentiometer cycle life*:	2.5 x 10 <sup>6</sup>	2.5 x 10 <sup>6</sup>	5 x 10 <sup>5</sup>	5 x 10 <sup>5</sup>	5 x 10 <sup>5</sup>	5 x 10 <sup>5</sup>	5 x 10 <sup>5</sup>	2.5 x 10 <sup>5</sup>	2.5 x 10 <sup>5</sup>	2.5 x 10 <sup>5</sup>

\*-1 cycle is defined as the travel of the measuring cable from full retraction to full extension and back to full retraction

### Enclosure Material:

<b>A</b> order code:	AL	SS	316
	powder-painted aluminum	303 stainless steel	316 stainless steel

# PT8DN

Heavy Industrial • DeviceNET® Communication

## Measuring Cable:

<b>B</b> order code:	<b>N34</b>	<b>S47</b>	<b>S31</b>	<b>V62</b>
cable construction:	Ø.034-inch nylon-coated stainless steel rope	Ø.047-inch bare stainless steel rope	Ø.031-inch bare stainless steel rope	Ø.058-inch PVC jacketed vectra fiber rope
available ranges:	<i>all ranges</i>	<i>5, 15, 20, 25, 30-inch only</i>	<i>40, 50, 60-inch only</i>	<i>thru 30 inches only</i>
general use:	indoor	outdoor, debris, high temperature	outdoor, debris, high temperature	high voltage or magnetic field

## Measuring Cable Tension:

<b>C</b> order code:	<b>T1</b>	<b>T2</b>	<b>T3</b>
	standard tension	medium tension	high tension
<i>full stroke range cable tension specifications</i>	2, 10-inch: 39 oz.	65 oz.	116 oz.
	15-inch: 26 oz.	43 oz.	77 oz.
	20, 40-inch: 20 oz.	33 oz.	60 oz.
	5, 25, 50-inch: 16 oz.	26 oz.	47 oz.
	30, 60-inch: 13 oz.	22 oz.	40 oz.
	tension tolerance: ± 50%		
	<i>maximum acceleration</i>	<i>maximum acceleration</i>	<i>maximum acceleration</i>
aluminum enclosure:	15 g	25 g	40 g
stainless steel enclosure:	6 g	12 g	18 g

## Cable Guide:

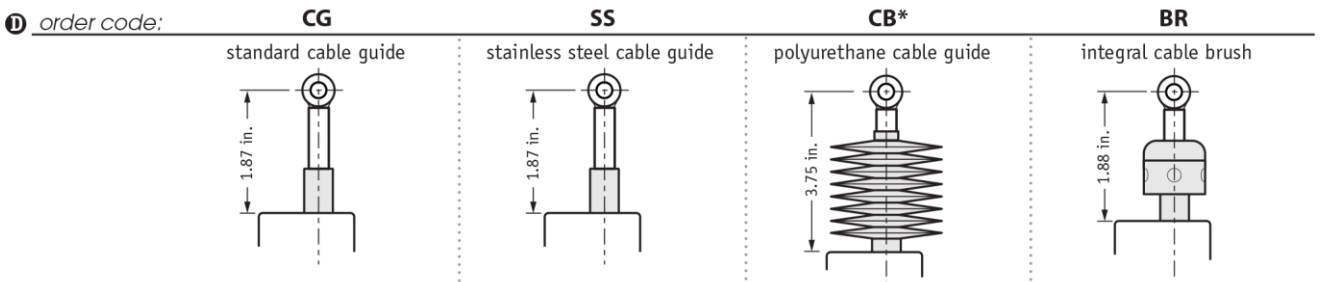

\*note: all ranges up to 25 inches only

## Baud Rate:



<b>E</b> order code:	<b>125</b>	<b>250</b>	<b>500</b>
	125 kbaud	250 kbaud	500 kbaud

## Terminating Resistor:

<b>F</b> order code:	<b>TR</b>	<b>NR</b>
	terminating resistor	no terminating resistor

**Electrical Connection:**

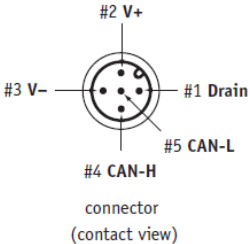
**order code:**

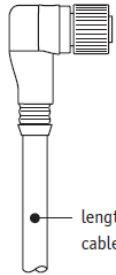
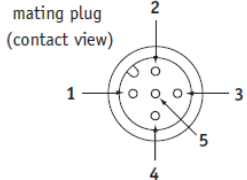
blank	MC5	SC5	NC5																		
5-pin micro-connector <i>(no mating plug supplied)</i>	5-pin micro-connector w/ mating plug	5-pin micro-connector and 5 meter length cordset w/straight mating plug	5-pin micro-connector and 5 meter length cordset w/90° mating plug																		
 <p>connector (contact view)</p>	 <p>0.16" - 0.32" OD Cable (THIN)</p>	 <p>length: 16ft [5M] cable: Thin</p>	 <p>length: 16ft [5M] cable: Thin</p>																		
	 <p>mating plug (contact view)</p>	<table border="1"> <thead> <tr> <th>pin</th> <th>signal</th> <th>wire color</th> </tr> </thead> <tbody> <tr> <td>1</td> <td>drain</td> <td>brown</td> </tr> <tr> <td>2</td> <td>V+</td> <td>white</td> </tr> <tr> <td>3</td> <td>V-</td> <td>blue</td> </tr> <tr> <td>4</td> <td>Can-H</td> <td>black</td> </tr> <tr> <td>5</td> <td>Can-L</td> <td>grey</td> </tr> </tbody> </table>	pin	signal	wire color	1	drain	brown	2	V+	white	3	V-	blue	4	Can-H	black	5	Can-L	grey	
pin	signal	wire color																			
1	drain	brown																			
2	V+	white																			
3	V-	blue																			
4	Can-H	black																			
5	Can-L	grey																			

**NORTH AMERICA**

Measurement Specialties, Inc.,  
a TE Connectivity company  
20630 Plummer Street  
Chatsworth, CA 91311  
Tel +1 800 423 5483  
Tel +1 818 701 2750  
Fax +1 818 701 2799  
info@celesco.com

**TE.com/sensorsolutions**

Measurement Specialties, Inc., a TE Connectivity company.

Measurement Specialties, TE Connectivity, TE Connectivity (logo) and EVERY CONNECTION COUNTS are trademarks. All other logos, products and/or company names referred to herein might be trademarks of their respective owners.

The information given herein, including drawings, illustrations and schematics which are intended for illustration purposes only, is believed to be reliable. However, TE Connectivity makes no warranties as to its accuracy or completeness and disclaims any liability in connection with its use. TE Connectivity's obligations shall only be as set forth in TE Connectivity's Standard Terms and Conditions of Sale for this product and in no case will TE Connectivity be liable for any incidental, indirect or consequential damages arising out of the sale, resale, use or misuse of the product. Users of TE Connectivity products should make their own evaluation to determine the suitability of each such product for the specific application.

© 2015 TE Connectivity Ltd. family of companies All Rights Reserved.

PT8DN 12/01/2015