



## LOW PRESSURE Intrinsically Safe Transducer AST44LP

### Overview

The AST44LP is a stainless steel pressure transducer with a wide variety of options. With its rugged construction and the best price-to-performance ratio in the industry, the AST44LP is the solution for low pressure measurement in Intrinsically Safe areas.

### Benefits

- Class I Div 1 Intrinsically Safe Groups C, D when installed with an approved barrier
- ATEX / IECEx: Class I Zone 0 Exia IIB T4 Ga (Ta = -40°C to +80°C)
- High Strength Stainless Steel Construction
- No Internal O-rings
- Wide Operating Temperature
- Pressures from 0-1 to 0-15 PSI
- Low Static and Thermal Errors
- Unparalleled Price and Performance
- Compatible with Wide Variety of Liquids and Gases

### Applications

- Industrial OEM Equipment
- HVAC/R Equipment
- Water Management and External Tank Levels
- Control Panels
- Pneumatics and Hydraulic Systems
- Vapor Recovery
- Data Loggers

## Environmental Data

### Ambient Temperature: 25°C (77°F) (Unless otherwise specified)

Operating Ambient	-40 to 80°C (-40 to 176°F)
Storage	-40 to 100°C (-40 to 212°F)

### Electromagnetic Compatibility (EMC)

Standard	Description	Test Value
EN55011	Radiated Emissions	Class A, 30-1000 MHz
EN61000-4-2	Electrostatic Discharge Immunity	±8 kV Air Discharge ±4 kV Contact Discharge, VCP, HCP
EN61000-4-3	Radiated Electromagnetic Field Immunity	10V/m, 30-2700 MHz 80% 1kHz AM Modulation
EN61000-4-4	Electrical Fast Transient/Burst Immunity	±0.5 kV, ±1 kV, ±2 kV on DC Mains ±0.5 kV, ±1 kV on I/O Ports
EN61000-4-5	Surge Immunity	±0.5 kV, ±1 kV, on I/O Ports & DC Lines
EN61000-4-6	Conducted immunity	10V rms, 0.15-80 MHz, DC Mains 10V rms, 0.15-80 MHz, I/O Ports 80% 1kHz AM Modulation
EN61000-4-8	Power Frequency Magnetic Field Immunity Test	30 A/m @ (50Hz, 60Hz) 3 orthogonal orientations

### Shock, Vibration & Ingress Protection (IP)

Standard	Description	Test Value
EN 60067-2-27	Shock Test	500m/s <sup>2</sup> , 6ms, half sine-wave, 6 shocks (3/direction), horizontal and vertical axis, 12 total shocks
EN 60068-2-6	Sinusoidal Vibration	5-25 Hz, 2mm, 25-150 Hz, 50m/s, Sweep rate: 1 octave/min, Duration: 24 hours/axis (48 hours total), horizontal and vertical axis
EN 60068-2-64	Random Vibration	10-2000 Hz, vibration level: 0.0314 (m/s <sup>2</sup> ) <sup>2</sup> /Hz, 24 hrs/axis (48 hrs total), 2 directions: horizontal and vertical
IEC 60068-2-32	Drop Test	Drop of 1 meter to floor made of concrete. Dropped twice on the threaded end and two times perpendicular to the threaded end.
IP-66	Ingress Protection	Dust-tight, protected against powerful water jets

**Performance**

**Ambient Temperature: 25°C (77°F) (Unless otherwise specified)**

Parameters	MIN	TYP	MAX	UNITS	NOTES
Accuracy	-0.25		+0.25	%Span	1
Accuracy (1 PSI)	-0.50		+0.50	%Span	1
Zero Error	-1.0		+1.0	%Span	2
Span Error	-1.5		+1.5	%Span	3
Span Error (4-20mA)	-2.0		+2.0	%Span	3
Thermal Error, Zero	-1.5		+1.5	%Span	4
Thermal Error, Span	-1.5		+1.5	%Span	5
Stability (1 year)		±0.25		%Span	
Proof Pressure		2X Rated Pressure		PSI	6
Burst Pressure		5X Rated Pressure or 75 (whichever is less)		PSI	7
Compensated Temp. Range		0 - 55° (32 to 132°)		°C (°F)	

**Electrical Data**

Model	AST44LP	
Output	4-20mA	1-5V, 1-6V
Excitation	10-28VDC	10-28VDC
Output Impedance	> 10k Ω	< 100 Ω
Current Consumption	-	<10mA
Output Noise	-	<2mV RMS
Output Load	0-800Ω	10k Ω Min.
Reverse Polarity Protection	Yes	Yes
Bandwidth	DC-250 Hz	DC-1kHz

**Notes**

1. The maximum deviation from a best fit straight line (BFSL) fitted to the output measured over the pressure range at 25°C. Includes all errors due to pressure non-linearity, hysteresis, and non-repeatability. Span is the algebraic difference between full scale output and zero pressure offset.
2. The maximum variation from the ideal offset measured at 25°C.
3. The maximum variation from the ideal full-scale span measured at 25°C.
4. The maximum variation of offset within the compensated temperature range relative to 25°C.
5. The maximum variation of full-scale span within the compensated temperature range relative to 25°C.
6. The maximum pressure that can be safely applied to the product for it to remain in specification once pressure is returned to the operating pressure range.
7. The maximum pressure that can be applied without causing escape of the pressure media.

**Dimensions & Electrical Connection**

Unless otherwise specified, all dimensions are in inches

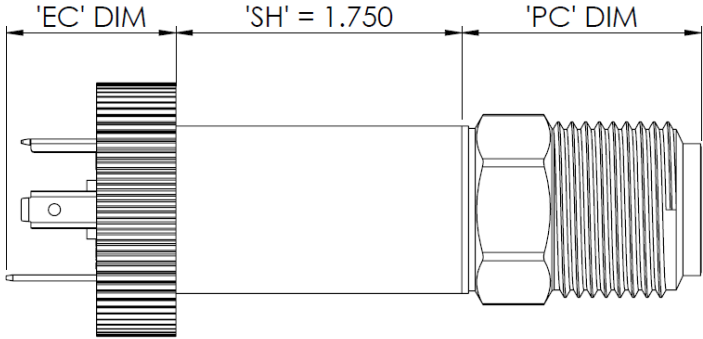
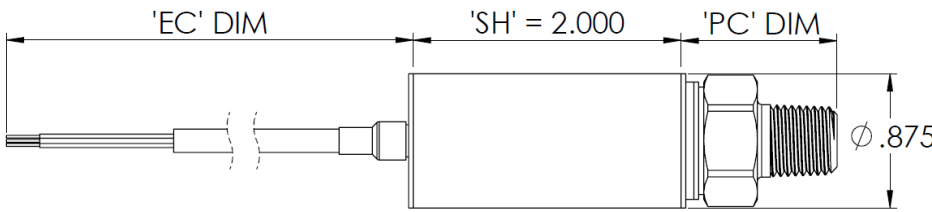
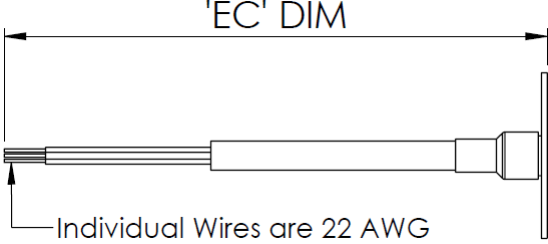
<p><b><math>EC + SH + PC = \text{Total Nominal Product Length}</math></b></p> 	<p><b>Only Connector I</b></p> <p>EC = Electrical Connector                  SH = Sensor Housing                  PC = Process Connection                  V = Voltage Supply                  N/C = Not Connected                  WP = Wide Pin                  S = Signal</p>																				
<p><b><math>EC + SH + PC = \text{Total Nominal Product Length}</math></b></p> 	<p><b>All Other Connectors</b></p> <p>EC = Electrical Connector                  SH = Sensor Housing                  PC = Process Connection                  V = Voltage Supply                  N/C = Not Connected                  WP = Wide Pin                  S = Signal</p>																				
<b>Electrical Connectors Option Codes</b>																					
<b>Cable</b>																					
<b>A</b> 2ft (0.6m)	<b>B</b> 4ft (1.2m)	<b>C</b> 6ft (1.8m)	<b>D</b> 10ft (3m)																		
<table border="1" style="width: 100%; border-collapse: collapse; text-align: center;"> <thead> <tr> <th>Color</th> <th>3 Wire Voltage</th> <th>4-20mA</th> </tr> </thead> <tbody> <tr> <td>Green</td> <td>N/C</td> <td>N/C</td> </tr> <tr> <td>Green (-SS only)</td> <td>Case</td> <td>Case</td> </tr> <tr> <td>Black</td> <td>GND</td> <td>-V</td> </tr> <tr> <td>Red</td> <td>+V</td> <td>+V</td> </tr> <tr> <td>White</td> <td>S</td> <td>N/C</td> </tr> </tbody> </table>	Color	3 Wire Voltage	4-20mA	Green	N/C	N/C	Green (-SS only)	Case	Case	Black	GND	-V	Red	+V	+V	White	S	N/C			
Color	3 Wire Voltage	4-20mA																			
Green	N/C	N/C																			
Green (-SS only)	Case	Case																			
Black	GND	-V																			
Red	+V	+V																			
White	S	N/C																			

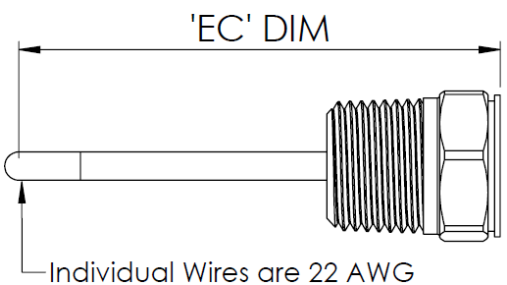
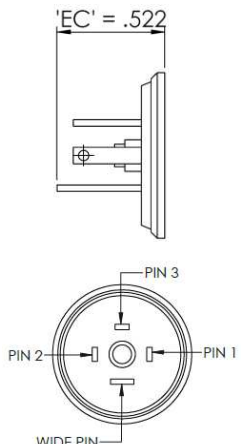
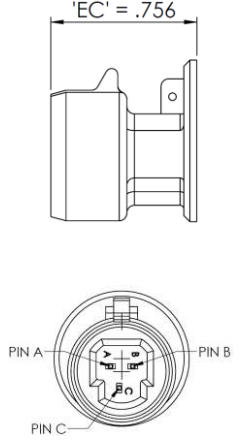
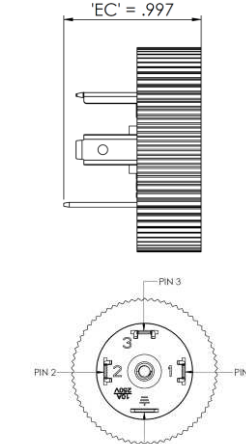
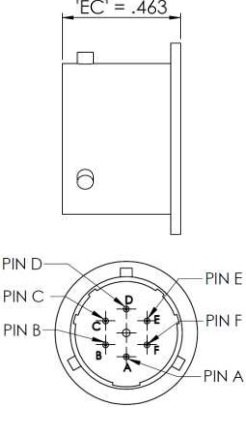
Electrical Connectors Option Codes (Cont'd)																																																																								
Conduit Cable																																																																								
L 2ft (0.6m)	M 4ft (1.2m)	N 6ft (1.8m)	P 10ft (3m)																																																																					
<table border="1"> <thead> <tr> <th>Color</th> <th>3 Wire Voltage</th> <th>4-20mA</th> </tr> </thead> <tbody> <tr> <td>Green</td> <td>N/C</td> <td>N/C</td> </tr> <tr> <td>Green (-SS only)</td> <td>Case</td> <td>Case</td> </tr> <tr> <td>Black</td> <td>GND</td> <td>-V</td> </tr> <tr> <td>Red</td> <td>+V</td> <td>+V</td> </tr> <tr> <td>White</td> <td>S</td> <td>N/C</td> </tr> </tbody> </table>		Color	3 Wire Voltage	4-20mA	Green	N/C	N/C	Green (-SS only)	Case	Case	Black	GND	-V	Red	+V	+V	White	S	N/C	 <p>'EC' DIM</p> <p>Individual Wires are 22 AWG</p>																																																				
Color	3 Wire Voltage	4-20mA																																																																						
Green	N/C	N/C																																																																						
Green (-SS only)	Case	Case																																																																						
Black	GND	-V																																																																						
Red	+V	+V																																																																						
White	S	N/C																																																																						
E DIN 43650C 8.0mm (Mini-DIN)	F Packard Metripack, 150	I DIN 43650A 18.0mm (Big- DIN)	R 6 Pin Bendix																																																																					
 <p>'EC' = .522</p> <p>PIN 3</p> <p>PIN 2</p> <p>PIN 1</p> <p>WIDE PIN</p> <table border="1"> <thead> <tr> <th>Pin</th> <th>3 Wire Voltage</th> <th>4-20mA</th> </tr> </thead> <tbody> <tr> <td>1</td> <td>S</td> <td>N/C</td> </tr> <tr> <td>2</td> <td>GND</td> <td>-V</td> </tr> <tr> <td>3</td> <td>+V</td> <td>+V</td> </tr> <tr> <td>WP (-SS only)</td> <td>Case</td> <td>Case</td> </tr> </tbody> </table>	Pin	3 Wire Voltage	4-20mA	1	S	N/C	2	GND	-V	3	+V	+V	WP (-SS only)	Case	Case	 <p>'EC' = .756</p> <p>PIN A</p> <p>PIN B</p> <p>PIN C</p> <table border="1"> <thead> <tr> <th>Pin</th> <th>3 Wire Voltage</th> <th>4-20mA</th> </tr> </thead> <tbody> <tr> <td>A</td> <td>GND</td> <td>-V</td> </tr> <tr> <td>B</td> <td>+V</td> <td>+V</td> </tr> <tr> <td>C</td> <td>S</td> <td>N/C</td> </tr> <tr> <td>C (-SS Only)</td> <td>Not Available</td> <td>Not Available</td> </tr> </tbody> </table>	Pin	3 Wire Voltage	4-20mA	A	GND	-V	B	+V	+V	C	S	N/C	C (-SS Only)	Not Available	Not Available	 <p>'EC' = .997</p> <p>PIN 3</p> <p>PIN 2</p> <p>PIN 1</p> <p>WIDE PIN</p> <table border="1"> <thead> <tr> <th>Pin</th> <th>3 Wire Voltage</th> <th>4-20mA</th> </tr> </thead> <tbody> <tr> <td>1</td> <td>+V</td> <td>+V</td> </tr> <tr> <td>2</td> <td>GND</td> <td>-V</td> </tr> <tr> <td>3</td> <td>S</td> <td>N/C</td> </tr> <tr> <td>WP (-SS Only)</td> <td>Case</td> <td>Case</td> </tr> </tbody> </table>	Pin	3 Wire Voltage	4-20mA	1	+V	+V	2	GND	-V	3	S	N/C	WP (-SS Only)	Case	Case	 <p>'EC' = .463</p> <p>PIN D</p> <p>PIN C</p> <p>PIN B</p> <p>PIN E</p> <p>PIN F</p> <p>PIN A</p> <table border="1"> <thead> <tr> <th>Pin</th> <th>3 Wire Voltage</th> <th>4-20mA</th> </tr> </thead> <tbody> <tr> <td>A</td> <td>+V</td> <td>+V</td> </tr> <tr> <td>B</td> <td>S</td> <td>-V</td> </tr> <tr> <td>C</td> <td>N/C</td> <td>N/C</td> </tr> <tr> <td>D</td> <td>GND</td> <td>N/C</td> </tr> <tr> <td>E</td> <td>N/C</td> <td>N/C</td> </tr> <tr> <td>F</td> <td>N/C</td> <td>N/C</td> </tr> <tr> <td>F (-SS only)</td> <td>Case</td> <td>Case</td> </tr> </tbody> </table>	Pin	3 Wire Voltage	4-20mA	A	+V	+V	B	S	-V	C	N/C	N/C	D	GND	N/C	E	N/C	N/C	F	N/C	N/C	F (-SS only)	Case	Case
Pin	3 Wire Voltage	4-20mA																																																																						
1	S	N/C																																																																						
2	GND	-V																																																																						
3	+V	+V																																																																						
WP (-SS only)	Case	Case																																																																						
Pin	3 Wire Voltage	4-20mA																																																																						
A	GND	-V																																																																						
B	+V	+V																																																																						
C	S	N/C																																																																						
C (-SS Only)	Not Available	Not Available																																																																						
Pin	3 Wire Voltage	4-20mA																																																																						
1	+V	+V																																																																						
2	GND	-V																																																																						
3	S	N/C																																																																						
WP (-SS Only)	Case	Case																																																																						
Pin	3 Wire Voltage	4-20mA																																																																						
A	+V	+V																																																																						
B	S	-V																																																																						
C	N/C	N/C																																																																						
D	GND	N/C																																																																						
E	N/C	N/C																																																																						
F	N/C	N/C																																																																						
F (-SS only)	Case	Case																																																																						

**Electrical Connectors Option Codes (Cont'd)**

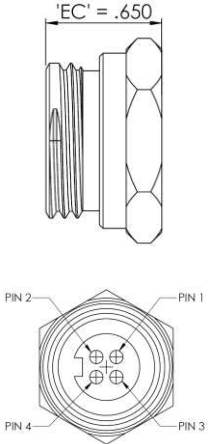
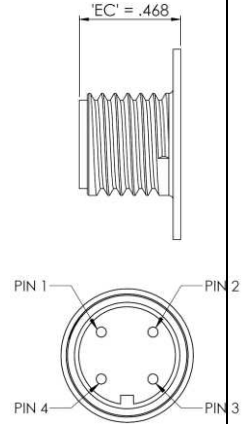
4 Mini-Fast (-SS Only)	Y M12X1																																	
 <table border="1" style="margin: 10px auto; border-collapse: collapse;"> <thead> <tr> <th>Pin</th> <th>3 Wire Voltage</th> <th>4-20mA</th> </tr> </thead> <tbody> <tr> <td>1</td> <td>GND</td> <td>-V</td> </tr> <tr> <td>2</td> <td>S</td> <td>N/C</td> </tr> <tr> <td>3</td> <td>+V</td> <td>+V</td> </tr> <tr> <td>4</td> <td>Case</td> <td>Case</td> </tr> </tbody> </table>	Pin	3 Wire Voltage	4-20mA	1	GND	-V	2	S	N/C	3	+V	+V	4	Case	Case	 <table border="1" style="margin: 10px auto; border-collapse: collapse;"> <thead> <tr> <th>Pin</th> <th>3 Wire Voltage</th> <th>4-20mA</th> </tr> </thead> <tbody> <tr> <td>1</td> <td>+V</td> <td>+V</td> </tr> <tr> <td>2</td> <td>N/C</td> <td>N/C</td> </tr> <tr> <td>2 (-SS only)</td> <td>Case</td> <td>Case</td> </tr> <tr> <td>3</td> <td>GND</td> <td>-V</td> </tr> <tr> <td>4</td> <td>S</td> <td>N/C</td> </tr> </tbody> </table>	Pin	3 Wire Voltage	4-20mA	1	+V	+V	2	N/C	N/C	2 (-SS only)	Case	Case	3	GND	-V	4	S	N/C
Pin	3 Wire Voltage	4-20mA																																
1	GND	-V																																
2	S	N/C																																
3	+V	+V																																
4	Case	Case																																
Pin	3 Wire Voltage	4-20mA																																
1	+V	+V																																
2	N/C	N/C																																
2 (-SS only)	Case	Case																																
3	GND	-V																																
4	S	N/C																																

**Pressure Port Option Codes**

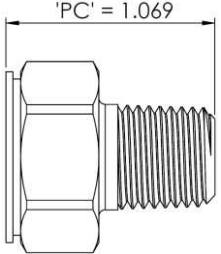
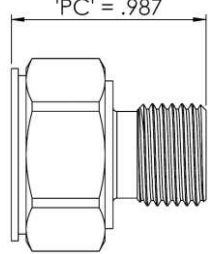
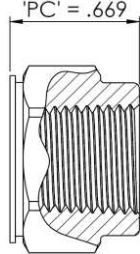
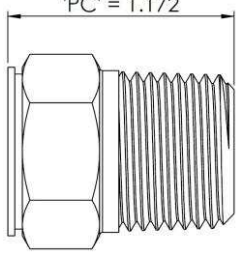
A 1/4 NPT Male	C 1/4 BSPP Male	I 1/4 NPT Female	P 1/2 NPT Male
			

**UL Approved Barrier Installation / A01657**

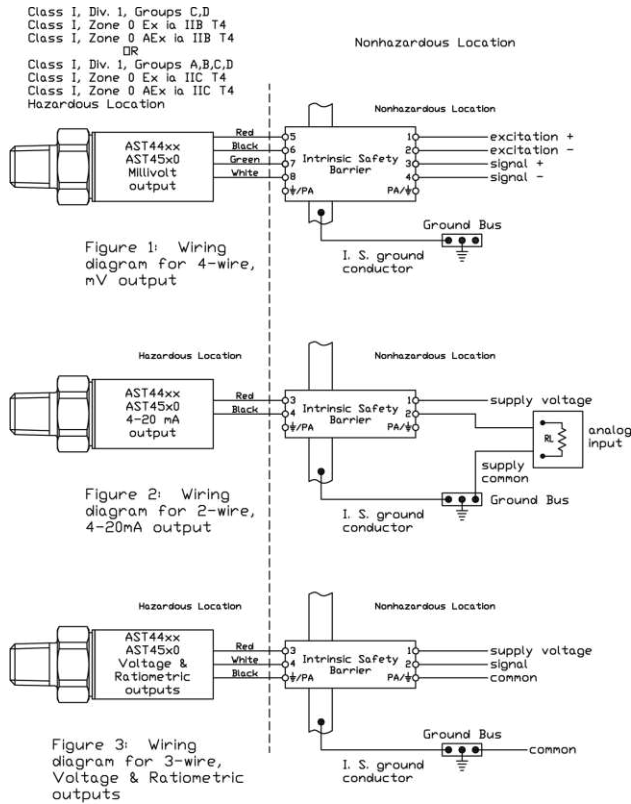

**CSA Approved Barrier Installation / A08949**

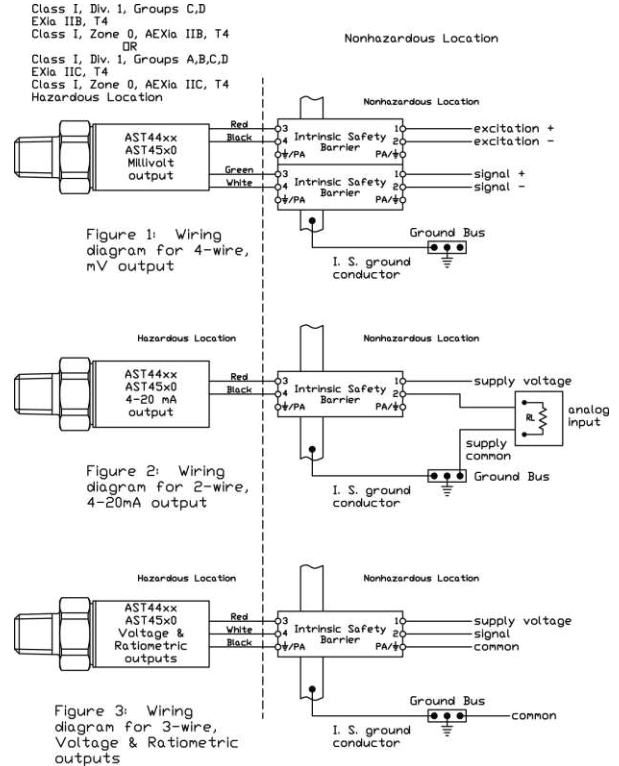

The transducers listed below are designed for installation in EITHER Class I, Division 1, Groups C,D; Class I, Zone 0 Group IIB DR Class I, Division 1, Groups A,B,C,D; Class I, Zone 0 Group IIC hazardous locations when connected to Associated Apparatus as described in note 1.

**Entity Parameters**

Models AST4400, AST44LP, AST4500, AST4510, AST4520  
 Class I, Div. 1, Groups C,D; Class I, Zone 0 Ex Ia IIB T4; Class I, Zone 0 AEx Ia IIB T4  
 Vmax = 28V

Model AST4401  
 Class I, Div. 1, Groups A,B,C,D; Class I, Zone 0 Ex Ia IIC T4; Class I, Zone 0 AEx Ia IIC T4  
 Vmax = 14.5V

4-20mA with integral connector	4-20mA with upto 1000ft of integral cable	All EXCEPT 4-20mA with integral connector	All EXCEPT 4-20mA with upto 150ft of integral cable
Pmax = 651 mW Imax = 93 mA Ci = 0.391 uF Li = 0 uH	Pmax = 651 mW Imax = 93 mA Ci = 0.434 uF Li = 0 uH	Pmax = 651 mW Imax = 93 mA Ci = 0.643 uF Li = 0 uH	Pmax = 651 mW Imax = 93 mA Ci = 0.649 uF Li = 0 uH

Isc or Io is the total current available from the Associated Apparatus under any condition.

**1. The following conditions must be satisfied:**

- Voc or Uo <= Vmax
- Isc or Io <= Imax
- Po <= Pi (if applicable)
- Total customer cable length for 4-20mA transmitters not to exceed 4000ft.
- Total customer cable length for all other transmitters not to exceed 150ft.
- Where the cable capacitance and inductance per foot are not known, the following values shall be used: Ccable = 60pF/ft, Lcable = 0.2uH/ft

**2. Control Room apparatus shall not generate in excess of 250V (Umax).**

**3. Canadian installations should be in accordance with Canadian Electrical Code, Part I. U.S. installations should be in accordance with Article 504 in the National Electrical Code, ANSI/NFPA 70.**

**Entity Parameters**

Models AST4400, AST44LP, AST4500, AST4510, AST4520, AST4530  
 Class I, Div. 1, Groups C,D; EXIa IIB, T4; Class I, Zone 0, AEXIa IIB, T4  
 Vmax = 28Vdc

Model AST4401  
 Class I, Div. 1, Groups A,B,C,D; EXIa IIC, T4; Class I, Zone 0, AEXIa IIC, T4  
 Vmax = 14.5Vdc

4-20mA with integral connector	4-20mA with upto 1000ft of integral cable	All EXCEPT 4-20mA with integral connector	All EXCEPT 4-20mA with upto 150ft of integral cable
Pmax = 625 mW Imax = 93 mA Ci = 0.391 uF Li = 0	Pmax = 625 mW Imax = 93 mA Ci = 0.434 uF Li = 155 uH	Pmax = 625 mW Imax = 93 mA Ci = 0.643 uF Li = 0	Pmax = 625 mW Imax = 93 mA Ci = 0.649 uF Li = 233 uH

**1. For installation in accordance with Fig 2, barrier must be a CSA Certified, Single Channel grounded Shunt-Diode Zener Barrier or a Single Channel Isolating Barrier.**

**2. For installations in accordance with Figs. 1 and 3, one dual-channel or two single-channel barriers may be used, where in either case, both channels have been Certified for use together with combined entity parameters.**

**3. The following conditions must be satisfied:**

$$Voc \text{ or } Uo \leq Vmax \quad Ca \text{ or } Co \geq Ci + Ccable$$

$$Isc \text{ or } Io \leq Imax \quad La \text{ or } Lo \geq Li + Lcable$$

$$Po \leq Pi \text{ (if applicable)}$$

**4. Maximum non-hazardous area voltage must not exceed 250 V.**

**5. Canadian installations should be in accordance with Canadian Electrical Code, Part I. U.S. installations should be in accordance with Article 504 in the National Electrical Code, ANSI/NFPA 70.**

**6. A grounding method is not provided by the manufacturer as part of the integral design of the Transducer. For units which are connected through a grounded shunt diode safety barrier, ensure that the transducer is mounted to a surface which is at the same potential as the barrier ground.**

**7. See user manual for installation conditions.**

Note: Float unused wires in cable. Insure that these wires are electrically isolated from other conductors

Legend	
✓	Standard Available
X	Not Available

**Available Process Connection, Material Configurations & Pressure Codes**

**316L PSI**

Pressure Range	Pressure Range Code	PSI Unit	Process Connection Code			
			A	C	I	P
0 - 1	00001	P	✓	✓	✓	✓
0 - 2.5**	00069	H	✓	✓	✓	✓
0 - 5	00005	P	✓	✓	✓	✓
0 - 7.5**	00208	H	✓	✓	✓	✓
0 - 10	00010	P	✓	✓	✓	✓
0 - 15	00015	P	✓	✓	✓	✓

**Hastelloy PSI**

Pressure Range	Pressure Range Code	PSI Unit	Process Connection Code			
			A	C	I	P
0 - 1	00001	P	X	X	X	X
0 - 2.5**	00069	H	X	X	X	✓
0 - 5	00005	P	X	X	X	✓
0 - 7.5**	00208	H	X	X	X	✓
0 - 10	00010	P	X	X	X	✓
0 - 15	00015	P	X	X	X	✓

\*See Ordering Information for list of options.  
 \*\*Must be ordered in inches H<sub>2</sub>O



# INDUSTRIAL OEM

AST44LP Pressure Transmitter

## Ordering Information

<b>AST44LP</b>	<b>A</b>	<b>00005</b>	<b>P</b>	<b>4</b>	<b>E</b>	<b>1</b>	<b>000</b>	<b>-ss</b>				
<b>Process Connection</b> A= 1/4" NPT Male C= 1/4" BSPP Male I= 1/4" NPT Female P= 1/2" NPT Male												
<b>Pressure Range</b> Insert Pressure Range Code (see table for availability)												
<b>Pressure Unit</b> P= PSI      H= Inches H <sub>2</sub> O												
<b>Output</b> 3= 1-5V 4= 4-20mA (2 wire loop powered) 6= 1-6V												
<b>Electrical Connection</b> A= 2 ft. (0.6m)                      L= Conduit, Cable 2 ft. (0.6 m) B= 4 ft. (1.2m)                      M= Conduit, Cable 4 ft. (1.2 m) C= 6 ft. (1.8m)                      N= Conduit, Cable 6 ft. (1.8 m) D= 10 ft. (3.0m)                     P= Conduit, Cable 10 ft. (3 m) E= Mini DIN 43650C                 R= 6- Pin Bendix F= Packard Metripack 150 3-Pin    Y= M12x1 I= DIN 43650A                         4 = Mini-Fast (-SS Only)												
<b>Wetted Material</b> 1= 316L      4= Hastelloy C276												
<b>Options Codes</b> 000= No Options												
<b>Approval Type</b> <table border="1"> <tr> <td>-SS</td> <td>CSA157 Class I Div 1 Groups C, D &amp; Class I Zone 0, AEx ia IIB T4 Intrinsically Safe when installed with approved barrier, ANSI/ISA 12.27.01 Single Seal and ATEX/IECEX: Ex ia IIB T4  Electrical Connection F not available</td> </tr> <tr> <td>Leave Blank</td> <td>UL ANSI/ISA 12.12.01 Class I Div 1 Intrinsically Safe Groups C, D (formerly UL913)  Not available for Electrical Connection 4</td> </tr> </table>									-SS	CSA157 Class I Div 1 Groups C, D & Class I Zone 0, AEx ia IIB T4 Intrinsically Safe when installed with approved barrier, ANSI/ISA 12.27.01 Single Seal and ATEX/IECEX: Ex ia IIB T4  Electrical Connection F not available	Leave Blank	UL ANSI/ISA 12.12.01 Class I Div 1 Intrinsically Safe Groups C, D (formerly UL913)  Not available for Electrical Connection 4
-SS	CSA157 Class I Div 1 Groups C, D & Class I Zone 0, AEx ia IIB T4 Intrinsically Safe when installed with approved barrier, ANSI/ISA 12.27.01 Single Seal and ATEX/IECEX: Ex ia IIB T4  Electrical Connection F not available											
Leave Blank	UL ANSI/ISA 12.12.01 Class I Div 1 Intrinsically Safe Groups C, D (formerly UL913)  Not available for Electrical Connection 4											

Note: CSA approved products require case/earth ground electrical connection. See wiring installation sheet for further details

### NORTH AMERICA

American Sensor Technologies, Inc. (AST),  
 a TE Connectivity Company  
 Tel: 800-522-6752  
 Email: [customercare.molive@te.com](mailto:customercare.molive@te.com)

### ASIA

Hong Kong Sensor Technologies (HKST),  
 a TE Connectivity Company  
 Tel: 0400-820-6015  
 Email: [customercare.shzn@te.com](mailto:customercare.shzn@te.com)

### TE.com/sensors

Measurement Specialties, Inc., a TE Connectivity company.

Measurement Specialties, TE Connectivity, TE Connectivity (logo) and EVERY CONNECTION COUNTS are trademarks. All other logos, products and/or company names referred to herein might be trademarks of their respective owners.

The information given herein, including drawings, illustrations and schematics which are intended for illustration purposes only, is believed to be reliable. However, TE Connectivity makes no warranties as to its accuracy or completeness and disclaims any liability in connection with its use. TE Connectivity's obligations shall only be as set forth in TE Connectivity's Standard Terms and Conditions of Sale for this product and in no case will TE Connectivity be liable for any incidental, indirect or consequential damages arising out of the sale, resale, use or misuse of the product. Users of TE Connectivity products should make their own evaluation to determine the suitability of each such product for the specific application.