

---

**ECOnect Tap**

---



*Figure 1*

## 1. INTRODUCTION

**ECOnect** connector, shown in figure 1, consists itself of two components: the first one with a “C” shape has adequate configuration to produce resilience (spring effect), and the second is a solid Wedge.

These components using, as base raw material, special aluminum alloys with high conductivity. The conductors’ accommodation grooves, from both “C” and Wedge components, come from factory impregnated with an anti-oxide paste. This compound assists to clean conductors that will be connected.

The **ECOnect** connectors have “RIF” (*Reduced Insertion Force*) technology, which eliminates the necessity of explosive gas generator cartridge use during the connection and also during the disconnection operations. “RIF” guarantees the maximum contact force with the minimum insertion force. Thus, for **ECOnect**’s application only becomes necessary the use of a high-torque electric screwdriver (whose the minimum requirement is: Torque 100N.m) or of a ratchet of at least 350mm (15 in) length.

**Note 1:** *The option by ratchet use is recommended only to realize a reduced number of connections. We strongly recommended the electric screwdriver use to realize a big quantity of connections.*

## 2. UTILISATION

**EConnect** connectors can be used to realize electrical connections involving only aluminum conductors (Aluminum-Aluminum) and, also, to bi-metallic connections involving aluminum and copper conductors (Aluminum-Copper). Bi-metallic connections are only allowed on non-aggressive environments (Non-corrosive environments). The adequate connector type for each conductor's combination must be chose in accordance with indicated in Table 1, showed below.

Type	PN	Diameter Limits					
		Sum of Diameters		Main		Tap	
		Min (mm)	Max (mm)	Min (mm)	Max (mm)	Min (mm)	Max (mm)
<i>Small</i>	1599783-1	10.41	13.46	5.18	8.38	4.11	6.55
	1599783-2	8.41	11.81	4.11	6.55	4.11	5.84
	1599783-3	13.08	16.66	6.55	10.11	5.18	8.38
	1599783-4	11.79	15.29	6.55	10.11	4.11	6.55
	1599783-5	14.81	18.39	6.55	10.11	6.55	10.11
<i>Medium I</i>	1599789-1	13.36	17.18	8.23	14.53	4.11	7.60
	1599789-2	16.67	21.46	8.23	14.53	4.11	11.79
	1599789-3	20.67	25.66	9.25	14.53	6.55	14.53
	1599789-4	24.86	28.70	9.25	14.53	9.25	14.53
<i>Medium II</i>	1599790-1	18.75	22.76	15.24	17.37	4.11	12.70
	1599790-2	22.77	27.01	15.24	17.37	6.55	14.27
	1599790-3	27.02	31.22	15.24	17.37	8.23	15.24
	1599790-4	31.21	34.75	15.24	17.37	11.68	17.37
<i>Medium III</i>	1599784-1	32.50	37.00	16.30	18.50	15.00	18.50
	1599784-2	29.00	33.10	16.30	18.50	12.70	14.60
	1599784-3	25.80	29.30	16.30	18.50	9.50	10.80
	1599784-4	25.76	28.46	16.30	18.50	7.41	10.11
	1599784-5	22.42	25.30	16.30	18.50	4.11	6.95

Table 1

### Example:

It's wished to do a derivation using a 16mm<sup>2</sup> copper wire from a 4AWG aluminum cable main line.

$$\begin{array}{lcl}
 \text{Main Line:} & 4\text{AWG Al Cable's Diameter} & \Rightarrow 6.36\text{mm} \\
 \text{Tap:} & 16\text{mm}^2 \text{ Cu Wire's Diameter} & \Rightarrow + 5.11\text{mm} \\
 & \text{Sum of Diameters} & \Rightarrow 11.47\text{mm}
 \end{array}$$

### Conclusion:

**PN 1599783-2** must be used.

The tables 2 and 3 show the approximated diameters, as reference, of most used cables in the **EConnect** connector's applications.

Size	Type	Diameter
6AWG	STR	4.65mm
2AWG	STR	5.88mm
1/0AWG	STR	9.36mm
4/0AWG	STR	13.28mm
336,4AWG	STR	16.90mm
6AWG	ACSR	5.04mm
4AWG	ACSR	6.36mm
2AWG	ACSR	8.01mm
1/0AWG	ACSR	10.11mm
4/0AWG	ACSR	14.31mm
266,4AWG	ACSR	15.45mm
336,4AWG	ACSR	17.35mm
336,4AWG	ACSR	18.30mm

Table 2

Size	Type	Diameter
16mm <sup>2</sup>	STR	5.11mm
25mm <sup>2</sup>	STR	6.39mm
95mm <sup>2</sup>	STR	12.30mm
120mm <sup>2</sup>	STR	14.50mm
150mm <sup>2</sup>	STR	16.25mm
185mm <sup>2</sup>	STR	17.75mm
25mm <sup>2</sup>	Comp	5.95mm
50mm <sup>2</sup>	Comp	8.04mm
95mm <sup>2</sup>	Comp	11.33mm
120mm <sup>2</sup>	Comp	12.80mm
150mm <sup>2</sup>	Comp	14.20mm
185mm <sup>2</sup>	Comp	16.00mm
185mm <sup>2</sup>	STR	17.75mm
240mm <sup>2</sup>	Comp	18.40mm

Table 3

### 3. PROCEDURES

#### 3.1 Conductors Preparation

The conductors to be connected should be carefully cleaned with a metallic brush (Figure 2), in order to remove the oxide surface layer existed in each conductor.

In case of insulated cables' use, they must have their insulation removed from 50 to 100mm in length, in accordance with "L" dimension shown in figure 3. If conductor's accommodation is necessary, we strongly recommend that it should be done before connector's application.



Figure 2

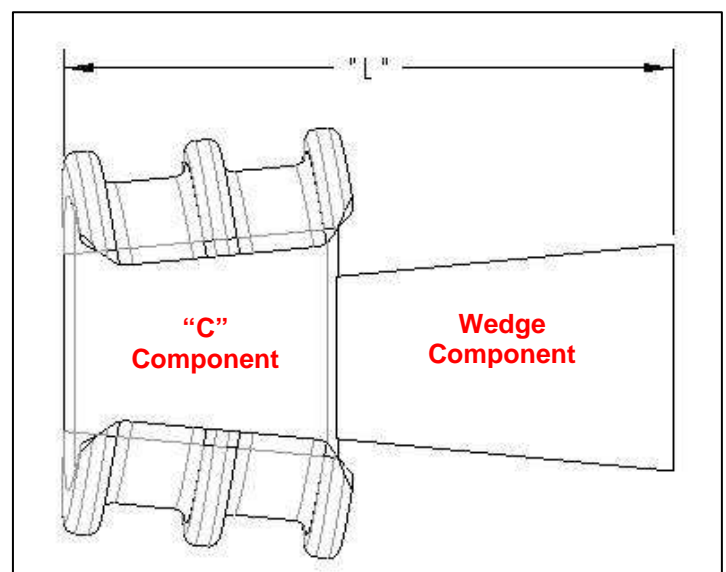

Figure 3

### 3.2 Connector's Choice Verification

Before of realize the application, the operator must check if available connector is the indicated to be used in the conductors' combination to be connected. It can be done consulting the Diameter Reference Table (Table 1).

This verification can also be done in the field, by the use of connector's plastic bag packing printed guide (Figures 4 and 5).



Figure 4

Tyco Electronics						
MEDIUM I ECONECT PN 0-1599789-2						
SOMA/SUM (mm)		PRINC./RUN (mm)		DERIVAÇÃO/ TAP (mm)		
MIN	MAX	MIN	MAX	MIN	MAX	
16.67	21.46	8.23	14.53	4.11	11.79	
COMBINAÇÕES PRINCIPAIS / MAIN CABLE COMBINATION						
AWG x AWG			mm <sup>2</sup> x mm <sup>2</sup>			
Princ. / Run		Deriv. / Tap		Princ. / Run	Deriv. / Tap	
3/0	→	6		95	→	16
ACSR		STR	SOL	STR		COMP
		ACSR	STR			STR
4/0	→	6 - 4		120	→	16
STR		COMP	SOL	COMP		COMP
ACSR		STR	STR	STR		STR
		ACSR	ACSR			STR
3/0	→	4 - 2		70	→	35
STR		COMP	SOL	STR		COMP
ACSR		STR	STR	STR		STR
		ACSR	ACSR			STR
4/0	→	2		95	→	35
COMP		COMP	SOL	COMP		COMP
STR		STR	STR	STR		STR
		ACSR	ACSR			STR
1/0	→	1/0		50	→	50
COMP		COMP	SOL	STR		COMP
STR		STR	STR	STR		STR
ACSR		ACSR	ACSR			STR
2/0	→	1/0		95	→	50
COMP		COMP	SOL	COMP		COMP
STR		STR	STR	STR		STR
ACSR		ACSR	ACSR			STR
Aplicação sem cartucho explosivo						
Application without Powder Cartridge						

Figure 5

### 3.3 Connection and Disconnection

#### 3.3.1 Connector's Set Up

First of all, insert Tap Conductor onto "C" member's accommodation, after that, insert this set ("C" + Tap Cable) in the main cable (Figure 6). The next step consisting of to fix this new set by the introduction the Wedge component (Figure 7). Operator must note that the correct Wedge's introduction position is that one that allows its larger groove fits the main conductor.

The set fixation is finalized with a hammer's assistance. Some **light hammer hits** must be applied on Wedge component's back part (Figure 8).

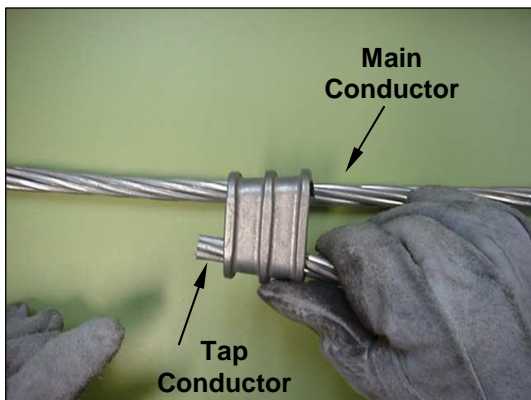

Figure 6



Figure 7



The set's ("C" + Wedge + Cables) fixation must be finalized by a hammer's use. It is to strain the Wedge with some **light hits**.

**Figure 8**

**Note 2:** In case of bi-metallic connections (aluminum-copper conductors), the copper conductor **always** must be below the aluminum conductor.

### 3.3.2 Use of EConnect's Solution

**EConnect** connectors' application must be realized with the aid of **EConnect** tool kits. These kits can be supplied in accordance with each customer's necessity and should be selected from drawing 1989151. Below there are some illustrations of IT-1000-23 Tyco Electronics' electrical tool (High Torque screwdriver) and of its accessories (Figure 9), as well of application head machined with its adapters (Figure 10).

**Reminder:** "**EConnect** connectors do not require cartridges use in their applications or in their extractions".



**Figure 9**

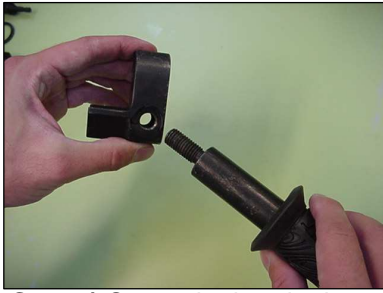

**Figure 10**

**Note 3:** The operation guide that comes with the electrical tool must be carefully read before starting its use. It describes how to obtain maximum possible performance and the applicable maintenance procedures.

### 3.3.3 EConnect's Application Tool's Assembling

The assembling of the adapters in the head is very easy to be done and it does not require operator's efforts. This assembly should be done in the ground in order to avoid components' losing by fall. The 5 steps shown in the figure below must be followed to assembly the application tool, when connectors Type Medium I, II and III are used. Additional 4 steps are necessary to apply Small Type connectors and they are indicated in the sequence of the first 5 steps.



**Step 1)** Screw the hand grip to the cradle.



**Step 2)** Join the washer to actuator module.



**Step 3)** Add the actuator module plus washer to the cradle.



**Step 4)** Put the actuator module in position and screws it to the head.



**Step 5)** Use pliers or similar tool to tighten the screw, completing the assembly.



**Assembled tool for Medium I, II and III Types connector's application.**

In case of a Small Type connector application (See Table 1), the Auxiliary Red Platform (Figure 11) must be added to the application tool shown above. The below new 4 steps demonstrate how to assemble it.



**Figure 11**



**Step 1)** Unscrew the actuator modules' screw to the farthest possible.



**Step 2)** Hook the auxiliary red platform over side application tool's head.

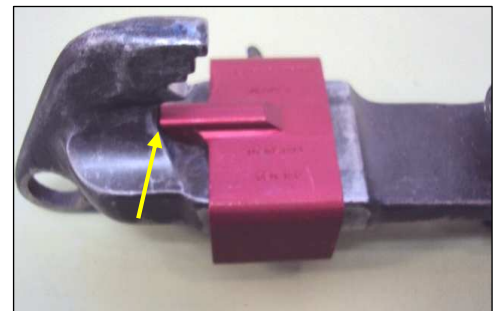

**Step 3)** Slide auxiliary red platform forward until its top lean against application tool's head.

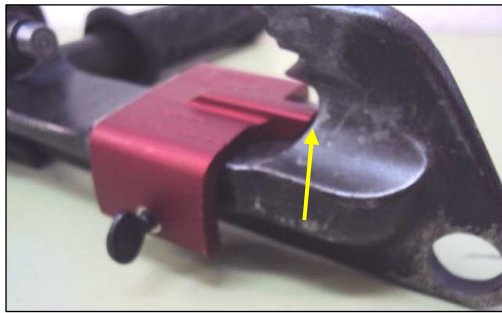

**Step 4)** Tighten strongly the fixing auxiliary red platform's thumbscrew. This piece must remain touching the tool's head.



**Assembled tool for Small Type connector's application.**

**3.3.4 EConnect's Application**

After putting cables and connector in the position, as described in the above item 3.3.1, insert the connector in the application tool and complete the connection, in accordance with 9 steps indicated in the below figure.



**Step 1)** Unscrew actuator modules' screw to insert the connector in the application tool.



**Step 2)** Turn back actuator modules' screw until it presses the Wedge component.



**Step 3)** Put connector in position guarantying that actuator screw is centralized and perpendicular to Wedge's back face.



**Step 4A)** Check electrical tool's rotation direction, before starting the application and, if necessary, change it.



**Step 5A)** Fit the appropriate socket (n°19 - mm) in the electrical tool for the application and join it to actuator screw.



**Step 6A)** Press the electrical tool's trigger to start the application. On average, the total application's time is 20 seconds.

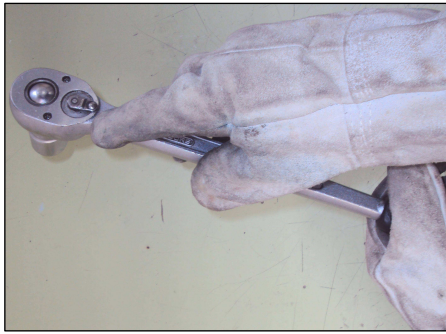

**Step 4B)** Check ratchet's tightening direction, before starting the application and, if necessary, change it.

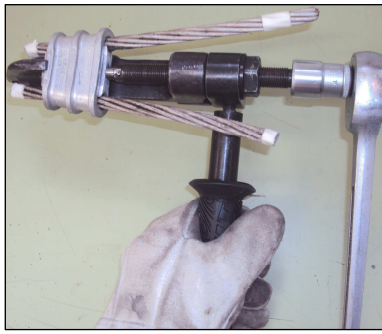

**Step 5B)** Fit the appropriate socket (n°19 - mm) in the ratchet for the application and join it to actuator screw.



**Step 6B)** Screw, with the ratchet, the actuator screw. On average, the total application's time is 60 seconds.

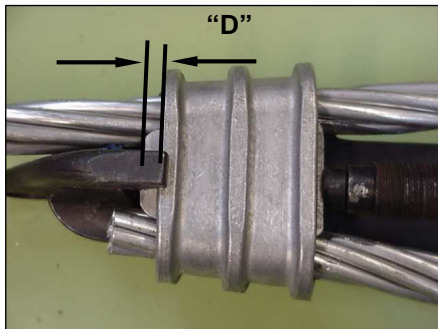

**Step 7)** A good lock is formed when Wedge is exposed conform **table 4**, below.



**Step 8)** Application will be finished when a good lock was formed in the Wedge.



**Step 9)** Reverse electrical tool's rotation direction to unscrew the actuator screw and to release the connector for tool's head.



**Step 9B)** Reverse ratchet's tightening direction to unscrew the actuator screw and to release the connector for tool's head.

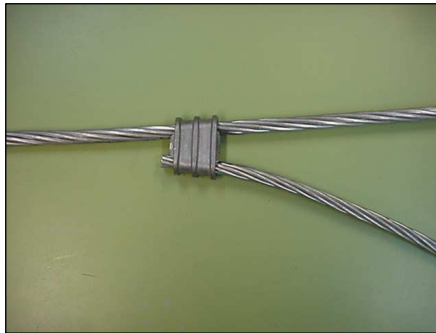

**Finished Application - Standard Lock**

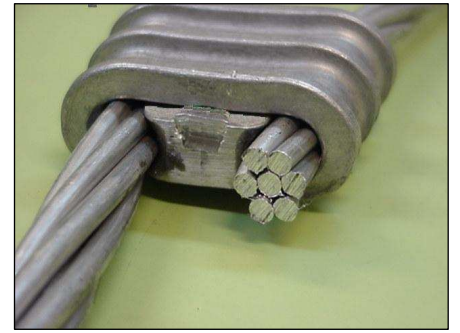

Type	Minimum "D" (mm)
Small	4.0
Medium I	6.0
Medium II	4.0
Medium III	

*Table 4*



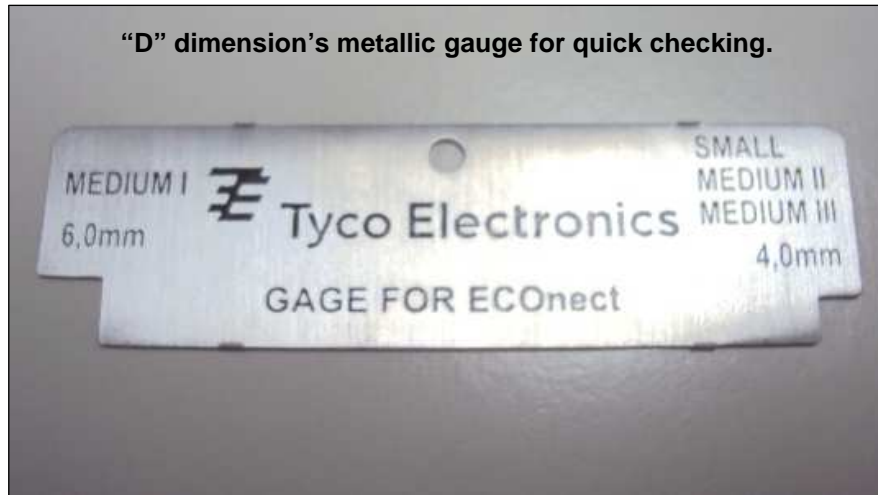

Figure 12

**Note 4:** “D” dimension, indicated in step 7 above, can also be verified with aid of metallic gage shown in figure 12. It can be ordered by code PN 19898708-1. This verification is shown in figure 13 and can be realized in both positions, horizontal and vertical.

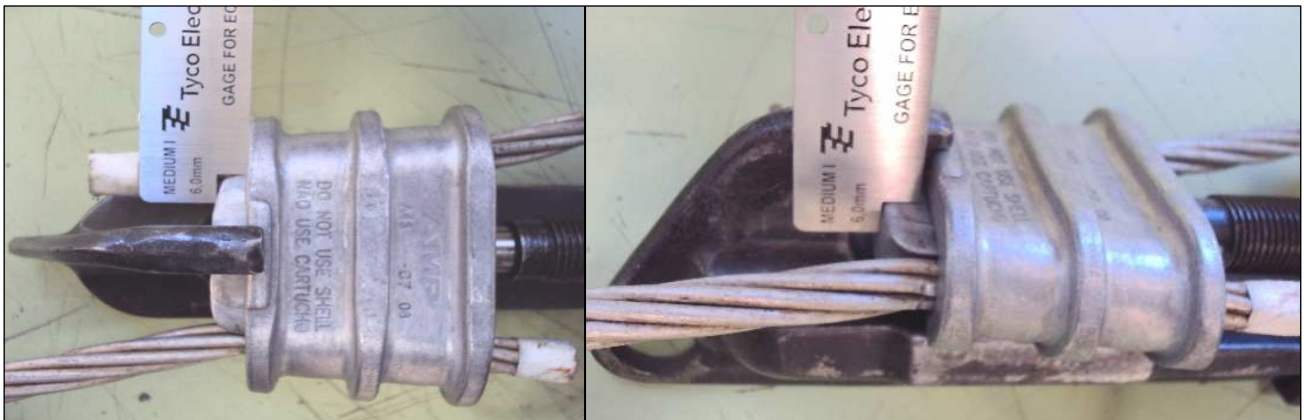

Figure 13

**Note 5:** Connector’s application only will be finished when a good lock is formed on the Wedge’s top. The last 9 steps must be repeated, in case of the obtained lock was not in accordance with visual standard presented above or if “D” dimension, indicated in table 4, was not reached.

### 3.3.5 EConnect’s Extraction

EConnect connector’s extraction procedure is similar to its application’s procedure and, therefore, as simple as this last one. The below illustrations demonstrate the required 4 steps for a correct execution of the EConnect connector’s extraction.



**Step 1)** Put the take-off clip in position, in the tool's head, leaving a free space available to put connector in the tool.



**Obs.1:** The hand grip's installation in the tool's head can be done in the two directions above. This provides flexibility to connector's application or extraction, adapting itself to the available operations' space.



**Step 2)** After put the take-off in the tool's head, insert this last one in the connector, such way Wedge is turned to the operators.

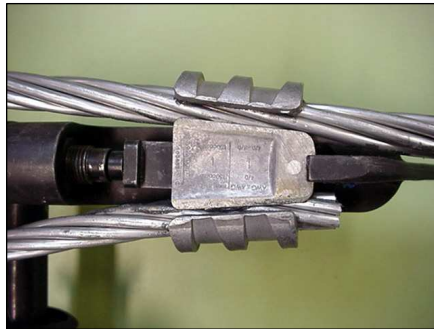

**Step 3)** Join the electrical tool to the actuator screw's axis and start the extraction.

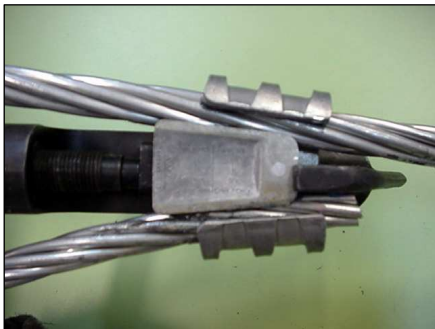

**Step 4)** After Wedge's retreat (unlocking), revert the electrical tool's rotation direction starting actuator screw's retreat to release the Wedge, finishing the extraction.



**Obs.2:** This connector has the same resilience (spring effect) technology presents in AMPACT connector's family and, therefore, it doesn't damage the conductors during the application or extraction operations.

**Reminder 1:** the rotation's direction for connector's extraction is the same that used for its application.

**Reminder 2:** the extraction also can be done using ratchet, with the same application's configuration and tightening direction.

**Note 6:** There are two different take-off clips' models, one to be used to extract Small Type Connectors (Figure 14) and other to be use to extract Medium I, II and III Type Connectors (Figure 15). Make sure you are using the appropriated model for your necessity.



Figure 14



Figure 15

**Note 7:** Clean and lubricate actuator screw, before and after each application or extraction sessions, this maintenance helps to extend equipment's life.

History				
Rev.	Date	Description	Prepared	Approved
C	13-Oct-2010	Release	Luis O. M. Borelli	J. A. La Salvia