

1. INTRODUCTION/DESCRIPTION

The AMP* SHEAR-LOK Grounding Connector is a wedge pressure connector that is designed to be used for applying ground wire to a grounding rod.

The connector can attach to the ground wire either at the wire end or at any intermediate point on the ground wire without requiring the ground wire to be cut.

The connector consists of a spring "C" body and a wedge, attached by a shear-head bolt. The bolt head is designed to shear at a predetermined torque, ensuring a proper connection

Reasons for reissue are provided in Section 5, REVISION SUMMARY.

2. STANDARD APPLICATION METHOD

1. Drive the ground rod into the final position.

CAUTION Do not drive ground rod after connector has been installed.

2. Using an approved mechanical method, clean the ground rod and wire in the area to be terminated.

3. Manually back out the shear-head bolt until the end of the bolt is flush with the front of the post on the "C" body.

4. Position the ground rod in the groove of the body marked $\frac{5}{8}$ (or $\frac{3}{4}$) on the wide end of the body.

5. Position the ground wire in the other groove of the body.

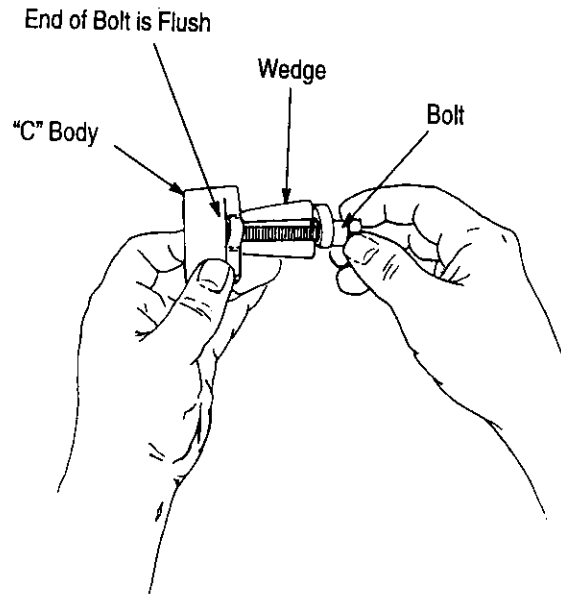

93-86

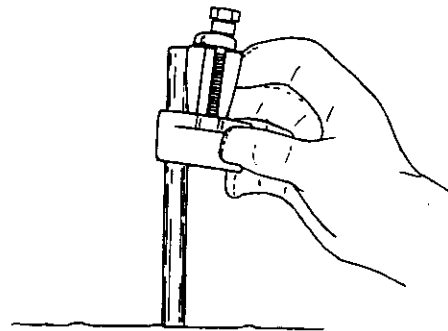

93-87

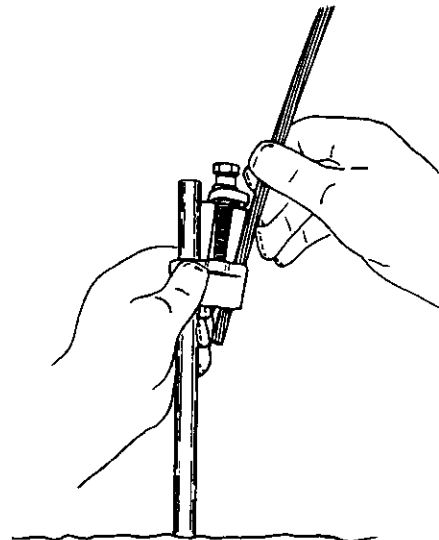

93-88

6. Push the wedge into the "C" body, making sure that the rod and wire are properly positioned in their respective grooves.

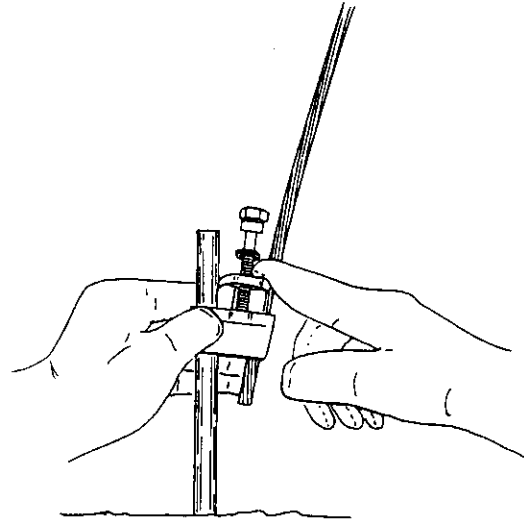

93-89

7. Pre-tighten the shear-head bolt by hand.

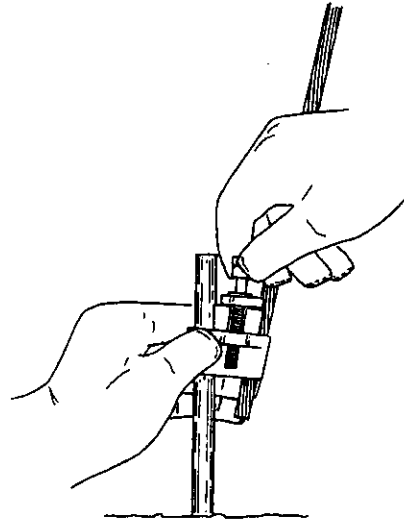

93-90

8. Using a socket wrench, tighten the shear-head bolt until the bolt head shears off. The connection is now complete.

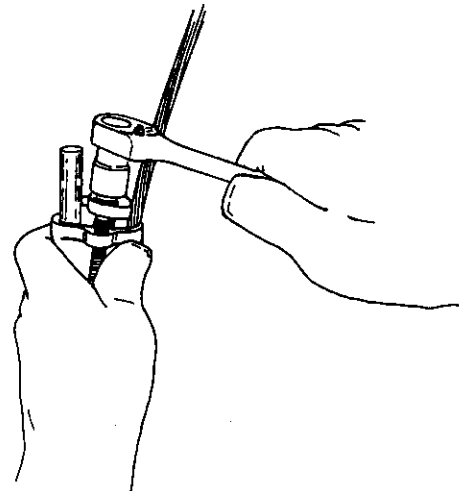

93-91

CAUTION

Do not misalign socket. Bolt head may shear at an incorrect torque when socket is misaligned and allowed to contact the bolt collar.

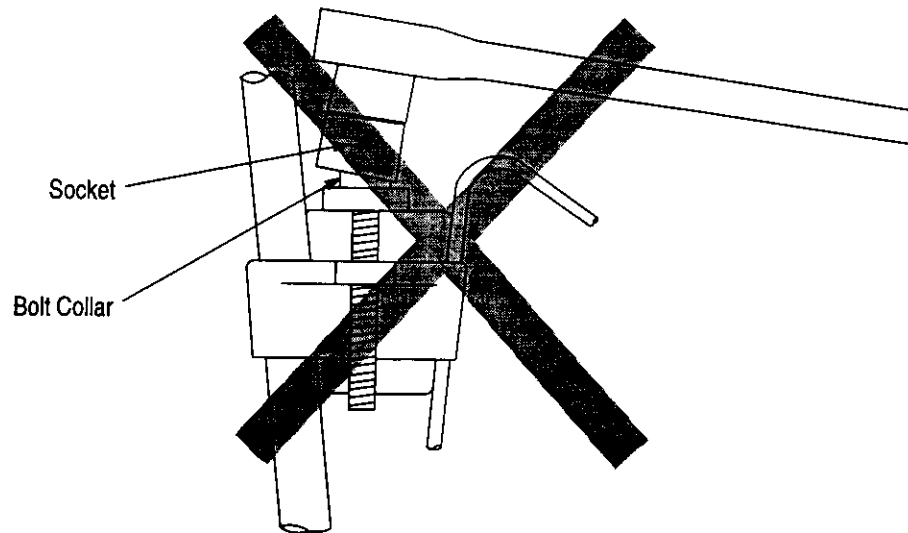
INCORRECT**NOTE**

To prevent socket from contacting bolt collar, use a socket with a depth of less than .375 in. to only seat over bolt shear head. If a shallow socket is not available, a modification to a deep socket can be achieved by inserting a 5/8 in. diameter rubber washer into socket to reduce the depth to .375 in. maximum.

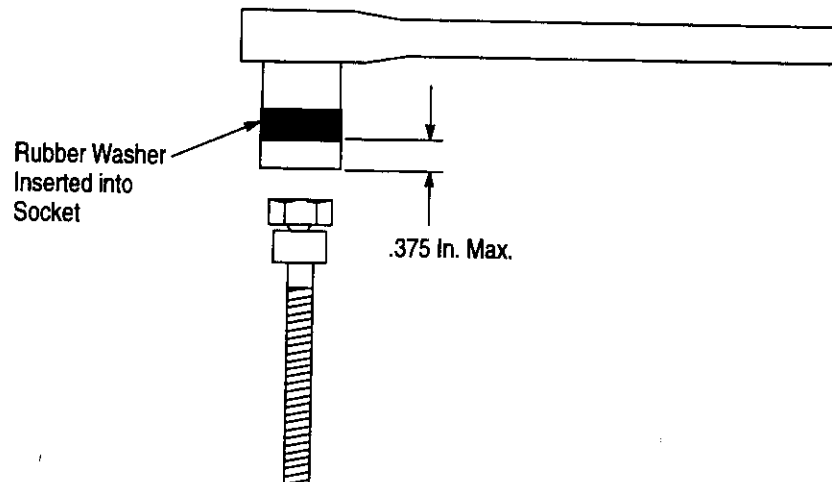

3. ALTERNATE PROCEDURE (FOR CONTINUOUS GROUND WIRE)

1. Follow Steps 1 through 4 in Section 2.
2. Rotate the wedge over the ground rod.

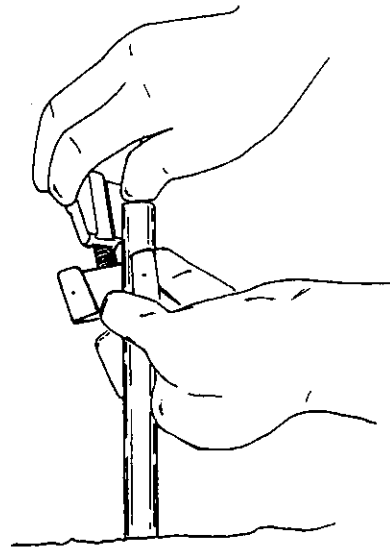

93-92

3. Position the ground wire in the other groove of the "C" body.
4. Rotate the wedge back into position and complete the connection by following Steps 6 through 8 in Section 2.

4. ADDITIONAL INFORMATION

For additional information, contact:

CUSTOMER SERVICE (38-35)
AMP INCORPORATED
PO BOX 3608
HARRISBURG PA 17105-3608

or

AMP OF CANADA LTD
20 ESNA PARK DR
MARKHAM ONTARIO
CAN L3R 1E1

HOTLINE U.S.:
1 800 722-1111

HOTLINE CAN.:
1 905 470-4425

FAX U.S.: 1 800 522-6752

FAX CAN.: 1 800 245-4356

or contact your local AMP Distributor.

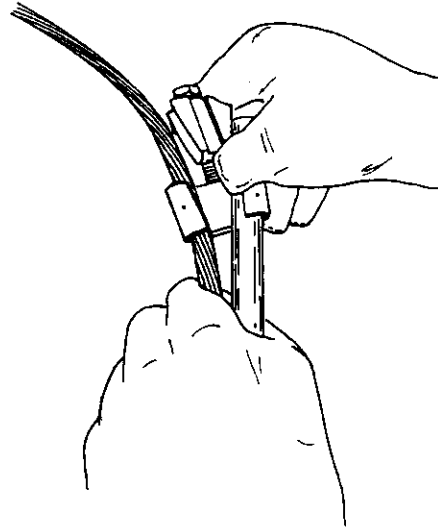

93-93

5. REVISION SUMMARY

Since the previous release of this sheet, the following changes were made:

Per EC 0990-0105-96:

- Added caution and note statements and corresponding illustrations after Step 8.
- Changed revision level from O to A.
- Changed area code for Canada Hotline from 416 to 905.