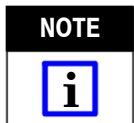

Figure 1

1. INTRODUCTION

PRO BEAM Sr. EB standard square-flange bulkhead connectors are designed to be installed onto jacketed fiber optic cable with aramid strength members.



Dimensions in this instruction sheet are in metric units. Figures are not drawn to scale.

The connector must be assembled using a bulkhead connector shell kit, an EB insert assembly kit, ferrule assembly kit (one for each fiber or channel), and a cable adapter kit. Sample part numbers are given in Figure 1. The combination of the kits selected is based on the diameter of the cable, the mode and quantity of fibers, and the operating wavelength of the system.



To avoid poor optical performance or permanent damage to the lens of the EB insert, use ONLY TE Connectivity ferrule assembly kits. Other manufacturers' ferrule assemblies ARE NOT compatible with the EB insert assembly kit.

These connectors are designed to be front-panel mounted.

Reasons for reissue of this instruction sheet are provided in Section 7, REVISION SUMMARY.

2. DESCRIPTION

Each kit contains the components shown in Figure 1.

The EB insert assembly kit is shipped with a white protective label on the back (end opposite the lens) of the EB insert and is installed immediately after final testing to keep the channel cavities clean. The EB insert is ready for assembly as shipped.

3. HANDLING



To avoid personal injury, NEVER look into the end of terminated or unterminated optical fibers. Laser radiation is invisible but can damage eye tissue.

- Do not touch the lenses of the EB insert with your fingers or with any tools

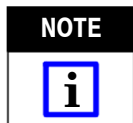

If any lens is touched or otherwise contaminated, clean the lens according to Instruction Sheet 408-8828.

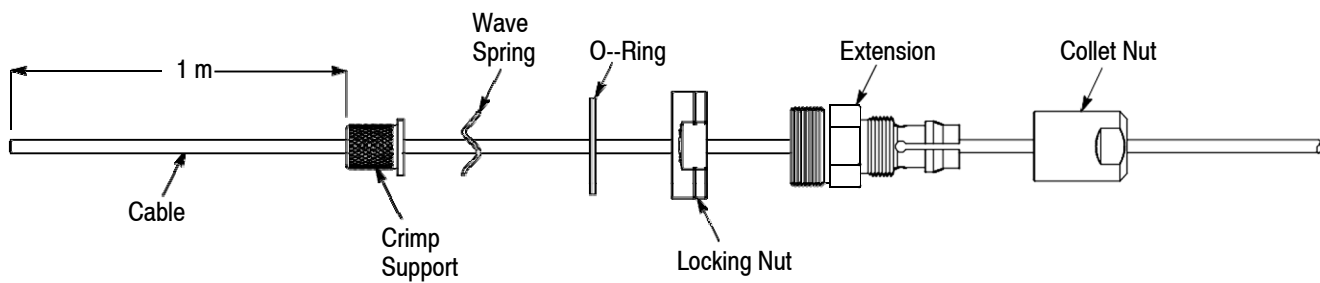
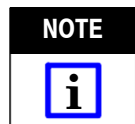

Figure 2

- Always have the protective cap installed or the connector mated to prevent contamination to the EB insert assembly

4. TOOLS AND MATERIALS

The following tools and materials are necessary for preparation, assembly, inspection, and maintenance of the connector and cable assembly. Follow the operating instructions packaged with the tools and safety guidelines packaged with the materials.



Items without a part number or supplier are customer supplied.

4.1. Tools

- cable jacket strip tool
- Aramid Shears 1278637-1
- SDE PEW 12 Hand Tool 91382-1 with Die Set 1673667-1 (408-8795)
- micrometer or vernier, dial, or digital caliper
- Fiber Stripping Tool 1278947-1 (408-4577)
- Heat Cure Oven Assembly 502134-1 (120 Vac) or -2 (240 Vac) includes universal heat cure block (408-9460)
- Curing Fixture 1693797-1 (408-8857)
- Sapphire Scribe Tool 504064-1 (408-4293)
- polishing machine (recommended) or Polishing Bushing 503337-1 (for hand polishing)
- 200x Microscope 1754767-1
- Ferrule Insertion Tool 1693820-1
- Housing Kit 1515841-1
- 3-mm hex wrench
- 26-mm open-end wrench
- 20-mm open-end wrench
- 16-mm open-end wrench

4.2. Materials

- Loctite 480 instant adhesive
- lint-free tissues or cloths
- isopropyl alcohol (99%) or acetone
- EPO-TEL 353ND-T epoxy
- Epoxy Applicator Kit 501473-3

For hand polishing only:

- 5- μ m Aluminum Oxide Polishing Film 228433-8
- 1mm Rubber Polishing Pad 501858-1 (green)
- 0.3- μ m Diamond Polishing Film 228433-5
- Final Polishing Film 502748-2
- lint-free applicator swabs
- Dow Corning Molykote 55 O-ring grease
- Loctite 243 threadlocker
- four 3-mm threaded fasteners (each with a minimum screw length approximately equal to the panel thickness plus 10 mm)

5. ASSEMBLY PROCEDURE

IMPORTANT: Assemble the connector using a laminar flow table in a clean environment meeting the requirements of International Organization for Standardization (ISO) 14644-1 (Class 5), “Cleanrooms and Associated Controlled Environments, Part 1.” Make sure that all components are free from contamination.

Proceed as follows:

5.1. Prepare the Cable

1. Slide the components shown in Figure 2 onto the cable allowing 1 meter at the end of the cable for stripping the cable. Make sure to orient each component as shown.
2. Using the cable jacket strip tool, strip the jacket to the dimension shown in Figure 3, exposing the strength members and fibers. Save the stripped piece of cable jacket for later use in Section 5.2.
3. Using the shears, trim the strength members to the length given in Figure 3.

Loctite, 480, and 243 are trademarks of Henkel Corporation.
Dow Corning and Molykote are registered trademarks of Dow Corning Corporation.
EPO-TEK is a trademark of Epoxy Technology Inc.

Cable Strip Length

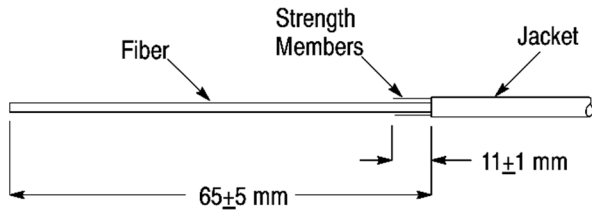

Note: Not to Scale

Figure 3

NOTE



These instructions are for single-channel connectors. For multi-channel connectors, perform the same assembly procedure for each channel.

5.2. Terminate the Fibers

1. Apply a continuous bead of the instant adhesive around the cable jacket between 4 and 5 mm from the stripped end of the jacket. See Figure 4, Detail A.

NOTE



Loctite 480 instant adhesive is a cyanoacrylate which hardens very quickly.

2. Rotate and slide the crimp support (large diameter end first) over the fiber and strength members and onto the jacket until it bottoms (rotating the crimp support between the thumb and index finger will help feed the strength members through the crimp support). See Figure 4, Detail B.

3. Apply a thin band of the instant adhesive around the knurled portion of the crimp support. Make sure that the band is continuous around the entire circumference. See Figure 4, Detail C.

4. Slide the piece of cable jacket (stripped from the cable in Paragraph 5.1) over the buffered fiber and into the center of the strength members until it bottoms against the crimp support and the strength members are flared away from the fiber. See Figure 4, Details D and E.

5. Slide the crimp sleeve over the fiber and piece of cable jacket so that the strength members fold back evenly around and over the crimp support and until it bottoms on the rear flange of the crimp support; then remove the piece of cable jacket. This step should be performed quickly before the adhesive begins to harden. See Figure 4, Detail E.

6. Remove the piece of cable jacket.

Detail A

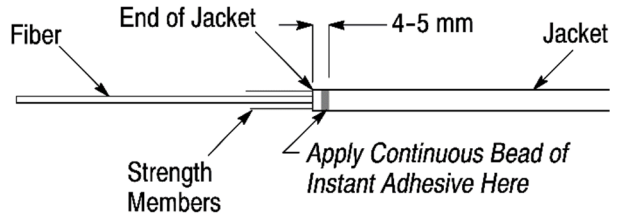

Detail B

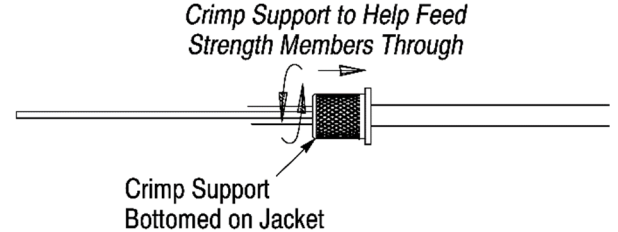

Detail C

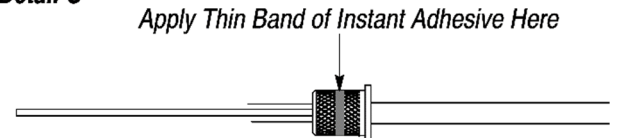

Detail D

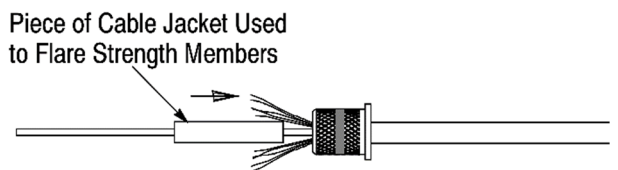

Detail E

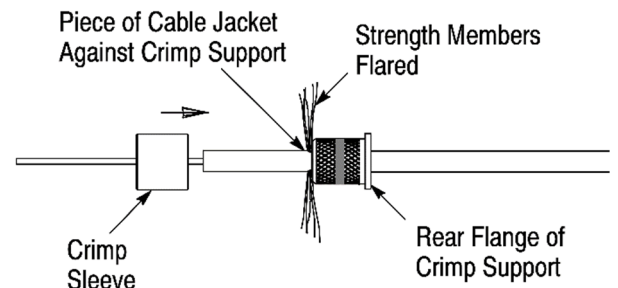

Figure 4

7. Place the crimp sleeve in the 8.6-mm hex nest of the hand tool, and crimp the crimp sleeve onto the crimp support. Make sure to position the crimp sleeve in the hex nest so that the crimp will locate from the back of the crimp sleeve to within the dimension shown in Figure 5, Detail A.

8. Using the micrometer or caliper, measure the crimp sleeve across the flats of the hex crimp to make sure that it conforms to the crimp height and crimp width shown in Figure 5, Detail B. If necessary, crimp again, and re-measure the crimp.

9. At the back of the crimp support, apply the instant adhesive around the circumference of the crimp support at the junction of the cable and the crimp support. Then at the front of the crimp sleeve, apply the instant adhesive over the opening of the crimp sleeve to encapsulate the strength members. See Figure 5, Detail C. Remove any excess adhesive.

10. Mark the fiber at the dimension shown in Figure 5, Detail D, and using the fiber stripping tool, strip the buffer to the mark, exposing the bare fiber. Using a lint-free tissue or cloth dampened with the isopropyl alcohol or acetone, clean the bare fiber.



Take care to not break the bare fiber. If any part of the fiber breaks, the crimp support and crimp sleeve must be replaced, and the cable must be re-stripped.

11. Slide the spring onto the fiber buffer. See Figure 5, Detail E.

12. Pre-heat the heat cure oven to 100°C.

13. Prepare the epoxy according to the following:

a. Remove the separating clip from the epoxy package. Mix the two components together thoroughly for 20 to 30 seconds.

b. Install the needle tip on the applicator from the epoxy applicator kit. Make sure it is secure. Remove the plunger.

c. Cut the epoxy packet open, and squeeze the epoxy into the back of the applicator. Re-assemble the plunger. Hold the applicator vertically, and slowly push on the plunger until the entrapped air escapes and a bead of epoxy appears at the needle tip.

d. Using a lint-free tissue or cloth dampened with the isopropyl alcohol or acetone, clean the tip of the applicator.

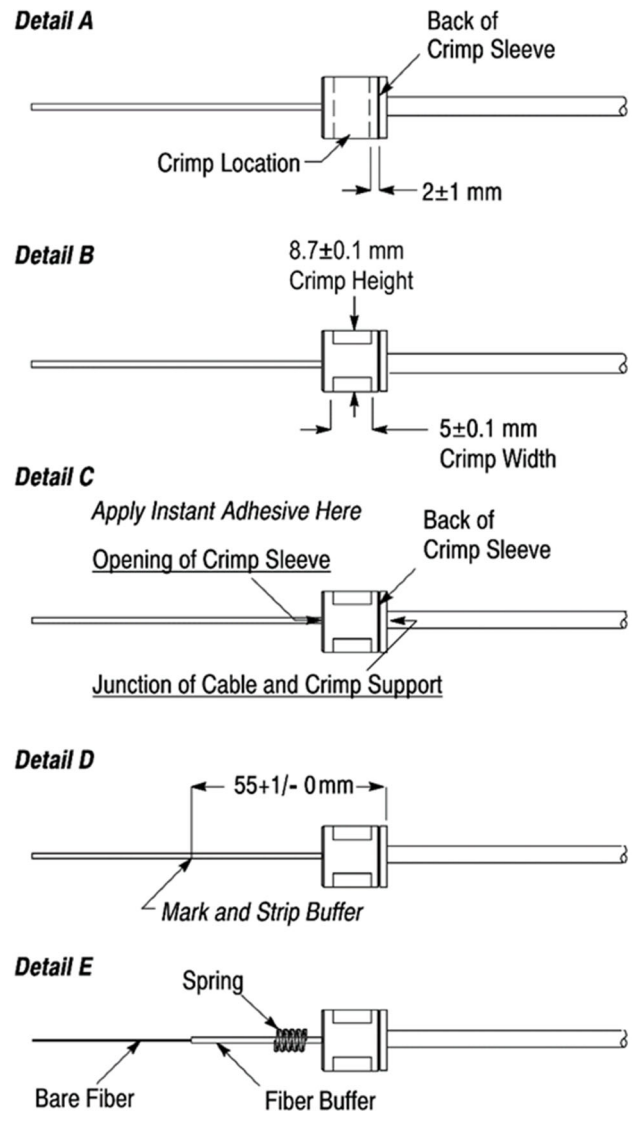

Figure 5

14. Perform the following for each ferrule assembly:

a. Hold the ferrule assembly vertically and insert the needle tip into the base of the ferrule assembly until it is against the back (end closest to the base) of the ferrule assembly. Refer to Figure 6.

b. While holding the ferrule assembly *firmly* against the needle tip, *slowly* inject the epoxy until a small bead of epoxy (approximately 0.75 mm in diameter) forms at the end face of the ferrule assembly. DO NOT allow the bead to get too large or smear.

c. Withdraw the needle slightly, and inject an additional small amount of epoxy so that the cavity at the base of the ferrule assembly is approximately one-third to one-half full.

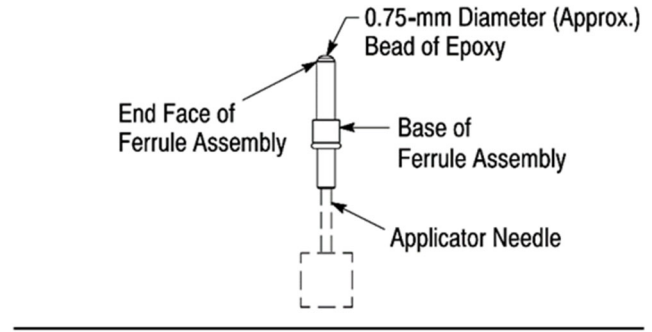

Figure 6



To avoid personal injury, remember that epoxy is a hazardous material, and pay particular attention to the following:

- ALWAYS follow manufacturer’s safety guidelines.
- ALWAYS wear protective gloves when using epoxy.
- ALWAYS use epoxy in a well-ventilated area.
- AVOID prolonged and frequent contact with skin.
- AVOID inhaling fumes from epoxy.

15. Place the crimp sleeve and fibers into the curing fixture according to the instructions included with the curing fixture.

Carefully insert each fiber into the back of a ferrule assembly (previously prepared with epoxy). Simultaneously slide and rotate each ferrule assembly on the fiber (to prevent any air pockets from being trapped in the epoxy) until it bottoms. Make sure that the bare fiber is protruding from the endface of the ferrule assembly. If it is not, re-strip and re-terminate the fiber.

Place the assembly in the curing fixture according to 408-8857 (instructions included with the curing fixture).

16. Cure the assembly in the heat cure oven for 20 minutes. Remove the curing fixture from the oven and allow it to cool to room temperature.

17. Remove the assembly from the curing fixture according to 408-8857. Measure the assembly to make sure that it conforms to the dimension given in Figure 7. If it does not, re-strip and re-terminate the fiber.

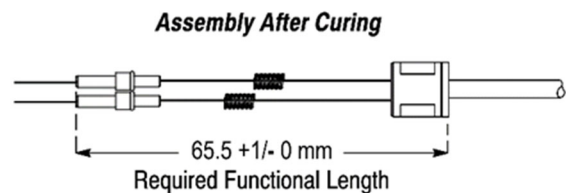
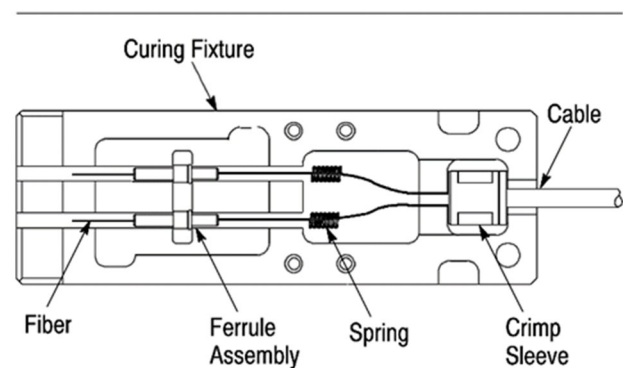
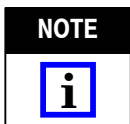

Figure 7



Although the curing fixture is designed to ensure that the required functional length is obtained, it is still important to measure the assembly to verify that this length has been met after curing.

5.3. Cleave the Fibers

For each ferrule assembly, firmly support the ferrule assembly, and draw the beveled edge of the scribe tool across the fiber as shown in Figure 8. After scoring the fiber, pull the fiber straight away from the ferrule assembly.

DANGER Safely dispose of excess fiber.

CAUTION To avoid damage to the tip of the scribe tool, DO NOT allow the scribe tool to contact the epoxy.

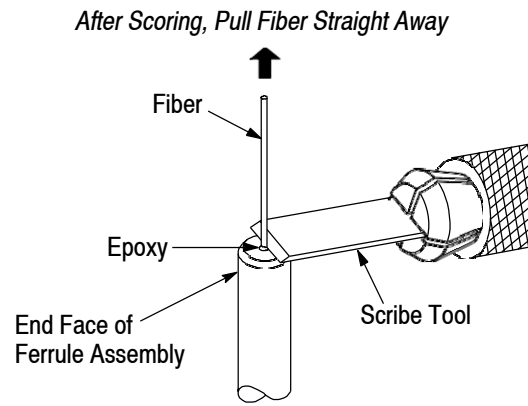

Figure 8

5.4. Polish the Fibers

It is recommended polishing the fibers using a polishing machine. Machine polishing will usually produce the best results. Polish the fibers according to the machine manufacturer's instructions. For best performance, as a minimum the polish should be an SPC (super physical contact) end finish for multimode, and a UPC (ultra physical contact) end finish for singlemode.

If machine polishing is not possible, hand polish each fiber according to the following:

1. Using a small piece of the 5- μ m polishing film, remove the fiber stub to the level of the epoxy.
2. Install the ferrule assembly onto the polishing bushing.
3. Place the green polishing pad on a hard, flat surface. Place the 5- μ m polishing film on the green polishing pad.
4. Hold the ferrule assembly and rest the tips of your index finger, middle finger, and thumb on the top of the polishing bushing. Starting with very light pressure, polish the tip of the fiber in a figure-8 pattern. Refer to Figure 9. Polish the fiber until the epoxy turns a very light yellow.

NOTE DO NOT remove all the epoxy. As the epoxy gets lighter, check the tip of the fiber frequently.

5. Clean the end face of the ferrule assembly and polishing bushing with isopropyl alcohol or acetone and a lint-free tissue.
6. Place the 0.3- μ m polishing film on the polishing pad. Polish in a figure-8 pattern. Stop polishing as soon as all the epoxy is removed.

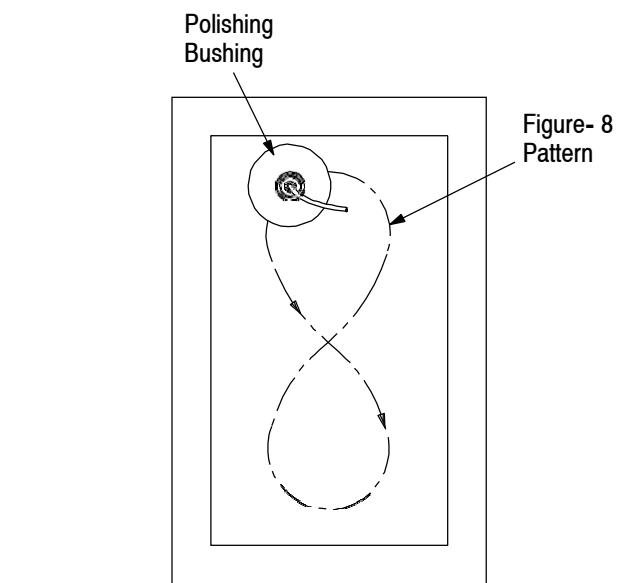

Figure 9

7. Clean the end face of the ferrule assembly and polishing bushing with isopropyl alcohol or acetone and a lint-free tissue.

8. Place the final polishing film on the polishing pad. Apply several drops of water to an unused area of the film. Move the ferrule assembly in 20-mm circles on the water for 25 seconds.

NOTE One sheet of final polishing film will be sufficient for 10 to 20 ferrule assemblies.

9. Remove the ferrule assembly from the polishing bushing. Clean the end face and sides of the ferrule assembly with isopropyl alcohol or acetone and a lint-free tissue.

5.5. Inspect the Ferrule Assemblies and Fibers



Never inspect or look into the end of a fiber when optical power is applied to the fiber. The infrared light used, although it cannot be seen, can cause injury to the eyes.

1. Using the microscope, inspect each ferrule assembly and fiber according to the following criteria (refer to Figure 10):

- Make sure that any epoxy is removed from the ferrule assembly
- Dirt may be mistaken for small pits. If dirt is evident on the ferrule assembly or fiber, clean with isopropyl alcohol or acetone and a lint-free tissue, then dry
- Fine polishing lines are acceptable
- Small peripheral chips (at the outer rim) on the fiber are acceptable
- Large chips in the center of the fiber and dark scratches are unacceptable, and the fiber must be re-terminated

2. If necessary, install the dust cover onto ferrule assembly to prevent contamination to the end face.

5.6. Complete the Assembly

1. Remove the protective label from the back (end opposite the lenses) of the EB insert.
2. Align the end of the ferrule assembly with the appropriate channel cavity of the EB insert, and insert the ferrule assembly into the channel cavity until the O-ring is against the channel cavity. See Figure 11, Detail A. To avoid damage to the fiber, DO NOT push on the fiber to install the ferrule assembly.

IMPORTANT: The channels for each fiber pair are designated on the EB insert with “A1” and “B1,” and “A2” and “B2”. For proper end-to-end system connection, connect A1-to-B1, B1-to-A1, A2-to-B2, and B2-to-A2.

3. Slide the spring over the fiber until it is against the O-ring of the ferrule assembly. See Figure 11, Detail B.
4. Using the ferrule insertion tool, **push on the spring** until the ferrule assembly bottoms in the channel cavity (the O-ring will be inside of the cavity, and the spring and ferrule will protrude slightly from the cavity). See Figure 11, Detail C.

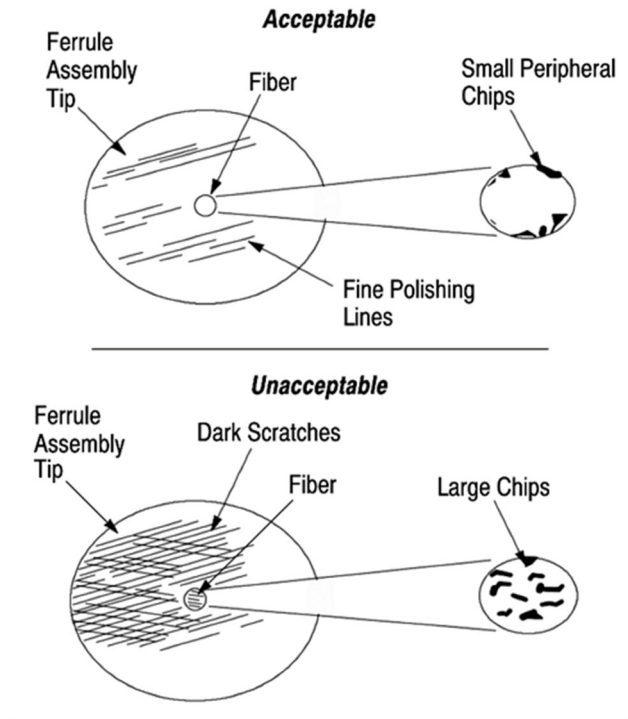

Figure 10

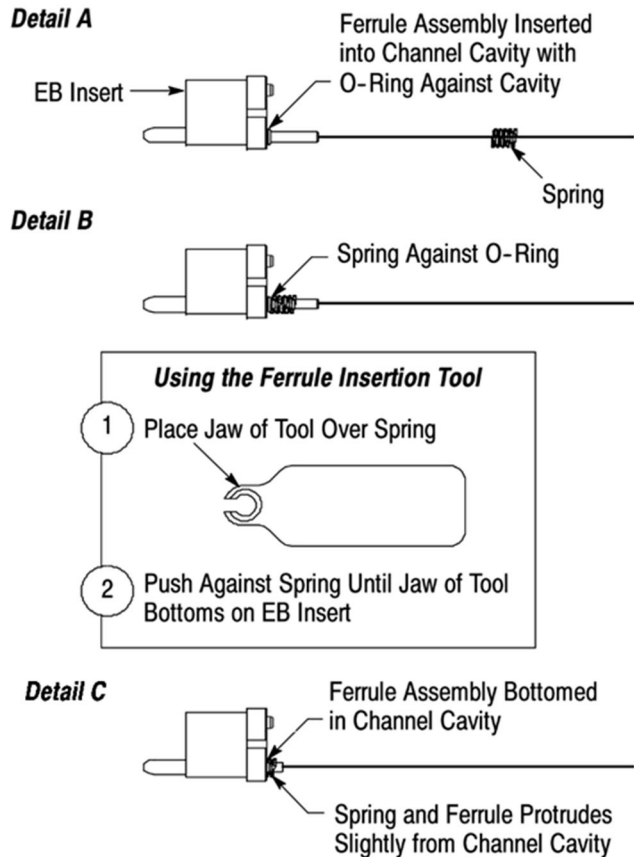

Figure 11

NOTE



If necessary, to remove the ferrule assembly from the cavity, firmly grasp the end of the ferrule assembly (but not the spring) with the needle-nose pliers, and pull it out of the cavity.

CAUTION



To avoid damage to the fiber, DO NOT PUSH OR PULL ON THE FIBER to install or remove the ferrule assembly from the cavity.

5. Align the U-slot of the ferrule plate with the plunger screw at the back of the EB insert, and slip the fiber into the slotted hole of the ferrule plate. See Figure 12, Detail A.

6. Holding the ferrule plate against the EB insert, thread the screw through the screw hole of the ferrule plate and into the hole of the EB insert. See Figure 12, Detail B. Using the 3-mm hex wrench, tighten the screw to a torque between 1.2 and 1.5 N·m. Check to make sure that the ferrule plate is flush with the EB insert.

7. Using an applicator swab, apply a *thin film* of the grease around the inside of the O-ring and around the inside of the front seal on the inside of the housing. Refer to Figure 13, Detail A. Remove any excess grease.

CAUTION



To avoid contaminating optical components, DO NOT use heavy deposits of the grease.

8. Align the external keys of the housing with the internal keyways of the square-flange housing. Slide the square-flange housing over the housing and push until it bottoms. See Figure 13, Detail B.

9. Slide the O-ring over the threads at the back of the housing and against the shoulder of the square-flange housing. Using an applicator swab, apply a *thin film* of the grease around the O-ring. See Figure 13, Detail C.

Detail A

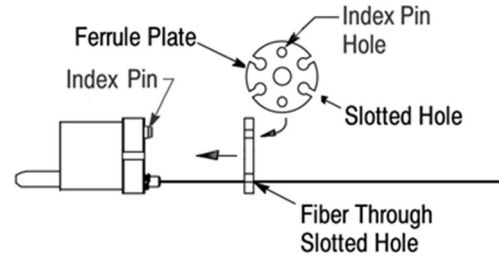

Detail B

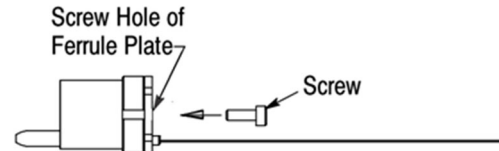
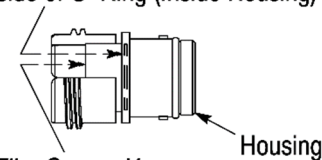

Figure 12

Detail A

Apply Grease Here
Inside of O-Ring (Inside Housing)



Apply Thin Film Grease Here
Inside of Front Seal (Inside Housing)

Detail B

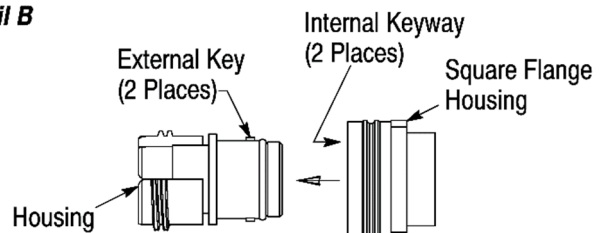

Detail C

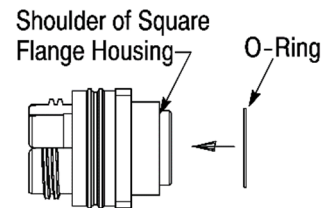

O-Ring
Apply Thin Film of Grease Here

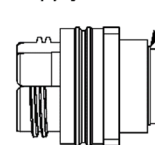
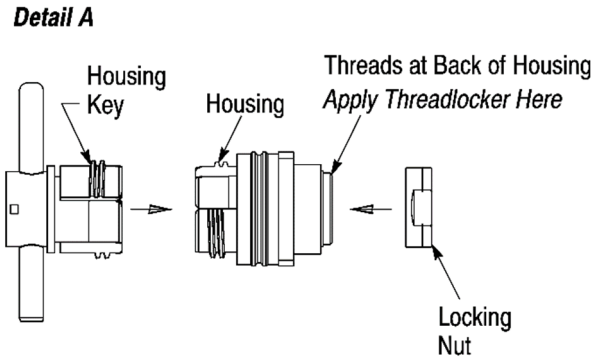
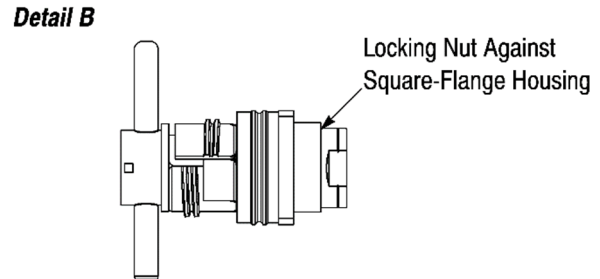

Figure 13

10. Push-fit the housing key onto the housing. Using the T-handle to hold the connector, apply 3 or 4 drops of threadlocker to the threads at the back of the housing. Refer to Figure 14, Detail A.



11. Reverse-thread the locking nut onto the housing. **These components have a left-hand thread.** The locking nut should capture the O-ring (installed in Step 6) and sit against the square-flange housing. Using the 26-mm open-end wrench, tighten the locking nut to a torque between 14 and 16 N·m. See Figure 14, Detail B.



12. Remove the housing key from the housing.

13. Align the internal key (small bar inside) of the housing with the keyway (slot along the side) of the EB insert, and slide the EB insert into the housing. See Figure 14, Detail C.

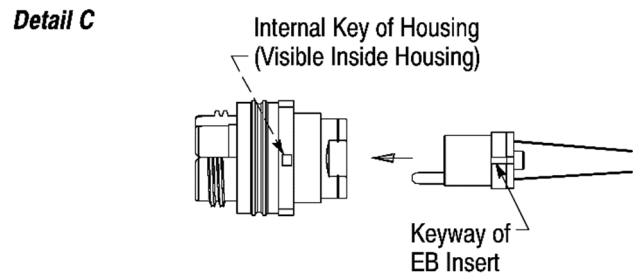

14. Using the 3-mm hex wrench, push the EB insert into the housing until it bottoms (when bottomed, the front edge of the EB insert should be flush with the front seal). To avoid damage to the fiber, DO NOT push the fiber or cable to install the EB insert. Refer to Figure 14, Detail D.

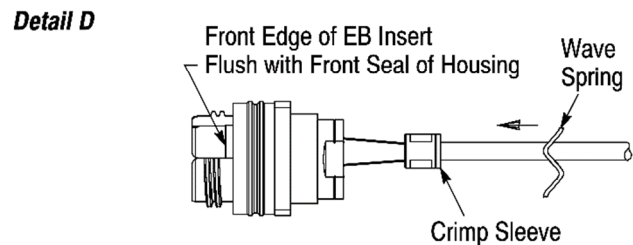

15. Slide the wave spring over the crimp sleeve and into the housing. See Figure 14, Detail D.

16. Apply 3 or 4 drops of the threadlocker to the threads at the front of the extension. Refer to Figure 14, Detail E.

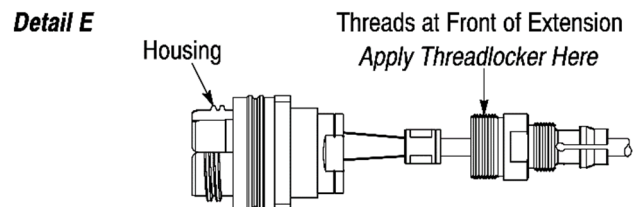

Figure 14

17. Check to make sure that the wave spring is flat against the EB insert. Then, while holding the cable jacket (to prevent the fibers from bending), slide the extension over the crimp sleeve and into the housing. Thread the extension until it is finger-tight (the extension should bottom on the back of the housing, and the crimp sleeve should not extend past the back of the extension). Be careful not to pinch, twist, buckle, or break the fibers. See Figure 15, Detail A.



CAUTION The wave spring must be flat against the EB insert BEFORE the extension is installed onto the housing; otherwise, damage to the wave spring may occur.

18. Push-fit the housing key onto the housing. Use the T-handle to hold the connector, and using the 20-mm open-end wrench, tighten the extension onto the housing to a torque between 10 and 15 N·m. Refer to Figure 15, Detail B.

19. Apply 3 or 4 drops of threadlocker to the threads at the back of the extension. Refer to Figure 15, Detail C.

20. Thread the collet nut onto the extension. Using the 16-mm open-end wrench, tighten the collet nut to a torque between 10 and 12 N·m. See Figure 15, Detail C.

21. Remove the housing key from the housing.

Detail A

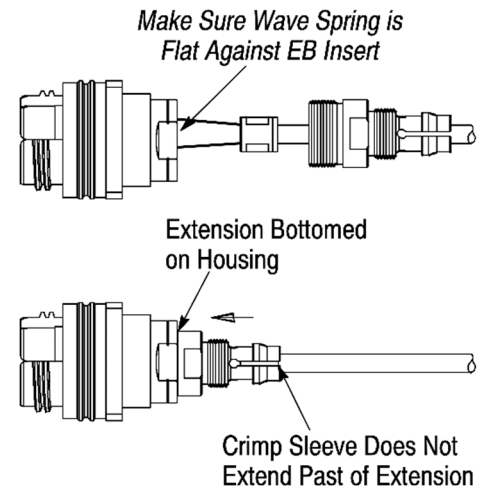

Detail B

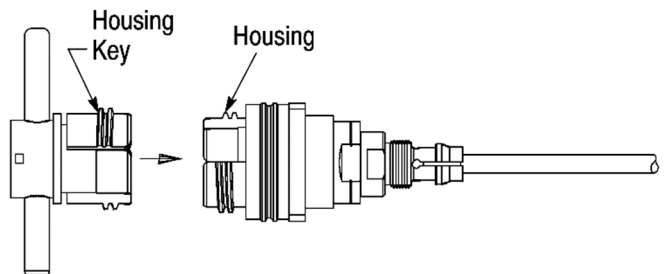

Detail C

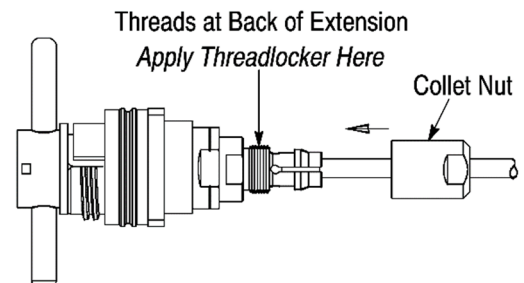

Figure 15

5.7. Mount the Connector onto the Panel and Install the Protective Cap

1. Cut the panel using the dimensions provided in Figure 16.

Recommended Panel Cutout

Panel Thickness Range of 1-8.5

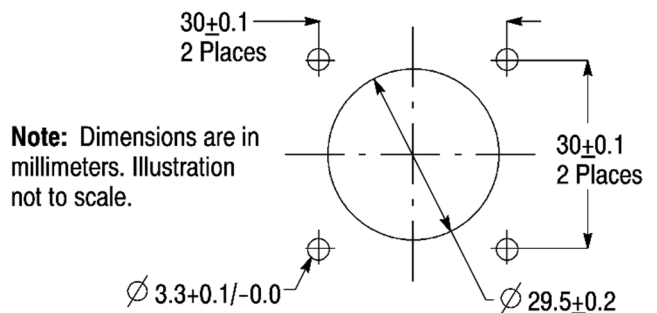

Figure 16

2. Install the connector through the front of the panel so that the flange O-ring of the square-flange housing is flat against the panel. See Figure 17, Detail A.

3. Secure the connector to the panel using the threaded fasteners described in Paragraph 4.2. Tighten the fasteners to the manufacturer's recommended torque value.

4. Fit the loop of the tether wire around the groove at the front (threaded end) of the square-flange housing. See Figure 17, Detail B.

5. Thread the protective cap onto the housing, then hand-tighten the protective cap as shown in Figure 17, Detail C.

6. REPLACEMENT AND REPAIR

Kit components are not repairable. DO NOT use any damaged or defective components. DO NOT attempt to re-use the crimp support, crimp sleeve, or ferrule assembly by removing the fiber.

Order replacement parts through your TE Connectivity representative, or call 1-800-522-6752, or use the LIVE CHAT on the www.te.com website.

7. REVISION SUMMARY

Revisions to this instruction sheet include:

- Updated document to current corporate requirements
- Section 4.1: updated fiber stripping tool and polishing bushing p/n's, removed epoxy p/n and replaced with recommended epoxy type, and removed polishing plate
- Section 5.4: revised singlemode/multimode polish requirements and Steps 3, 6, and 8
- Modified Figures 11, 12, and 14 to illustrate revised EB insert and ferrule plate designs
- Revised text of Section 5.6, Step 4

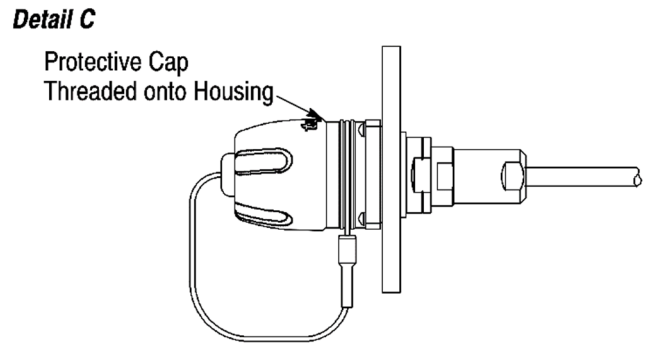
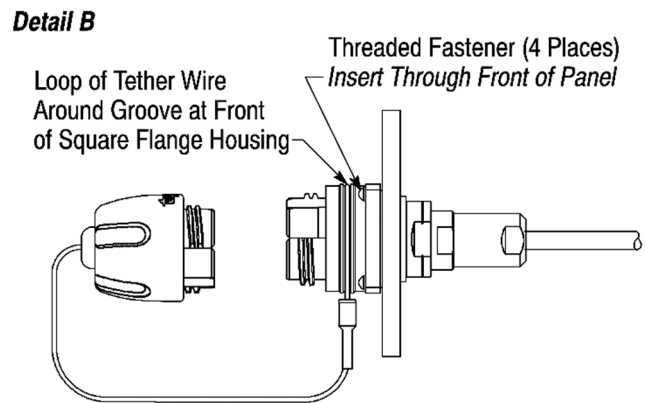
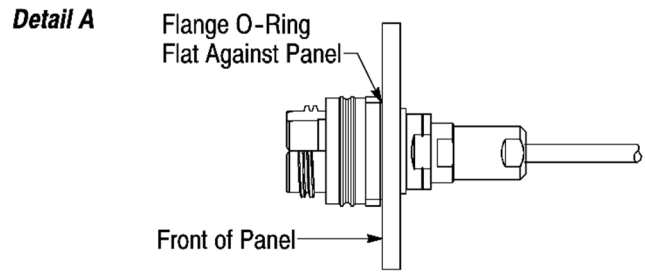

Figure 17