

TFT-150E-G

5-15kV Cold Applied Indoor
(5-8 kV Indoor and Outdoor)
Termination for Copper Tape,
Wire Shield, Lead Sheath and
UniShield® Cable

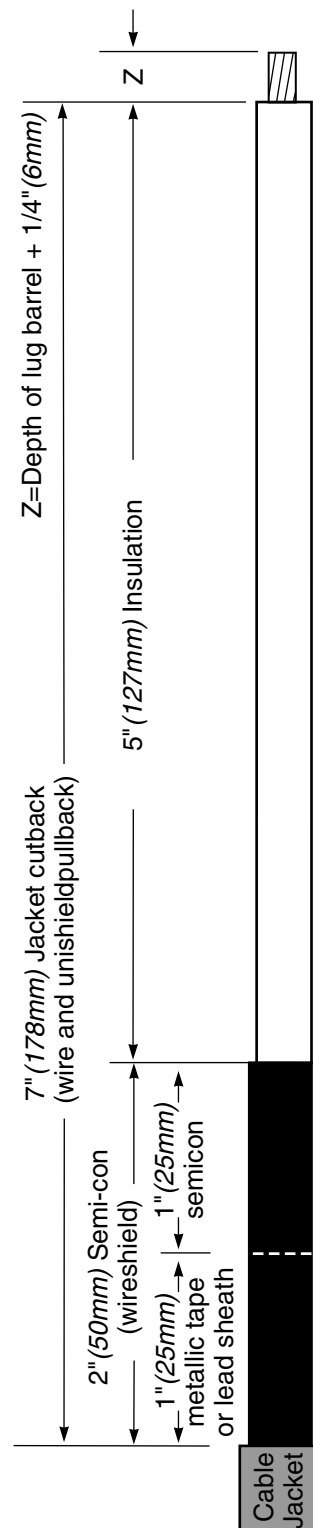
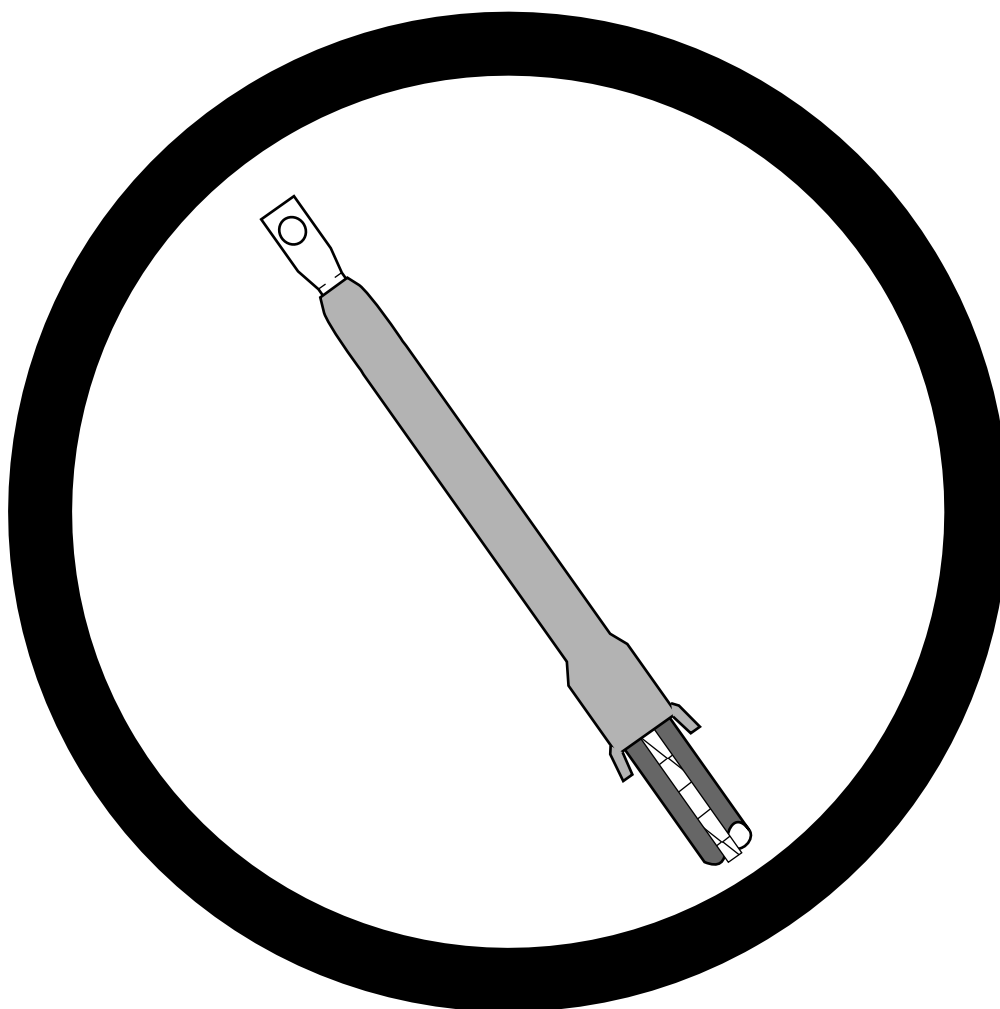

Kit Contents

- 1 Installation Instruction
- 1 Silicone housing on holdout
- 1 Stress control patch
- 1 Roll spring
- 1 Solder blocked ground braid
- 2 Adhesive backed copper tape strips
- 1 Cloth tape
- Sealant tape strips

Suggested Installation Equipment (not supplied with kit)

- | | | |
|--|---|--|
| <ul style="list-style-type: none"> • Cable preparation tools • Clean, lint-free cloths | <ul style="list-style-type: none"> • Electrician's tape • Connector(s) and installation tools | <ul style="list-style-type: none"> • Raychem P63 cable preparation kit or cable manufacturer approved solvent |
|--|---|--|

Safety Instructions

Warning: When installing electrical power system accessories, failure to follow applicable personal safety requirements and written installation instructions could result in serious or fatal injuries.

As Raychem has no control over field conditions which influence product installation, it is understood that the user must take this into account and apply his own experience and expertise when installing product.

Cleaning the Cable

Use an approved solvent, such as the one supplied in the P63 Cable Prep Kit, to clean the cable. Be sure to follow the manufacturer's instructions. Failure to follow these instructions could lead to product failure.

Some newer solvents do not evaporate quickly and need to be removed with a clean, lint-free cloth. Failure to do so could change the electrical characteristics of the cable or leave a residue on the surface.

Please follow the manufacturer's instructions carefully.

Installation Instructions

1. Select product.

Check kit selection with cable diameter dimensions in table 1 below.

Table 1

Kit	Nominal Conductor Size			Min/max Insulation ODs*
	5kV (in/outdoor)	8kV (in/outdoor)	15kV (indoor only)	
TFT-151E-G	2/0-250 kcmil	1/0-250 kcmil	#2-250 kcmil	0.64-1.09" (16-28mm)
TFT-152E-G	350-500 kcmil	250-500 kcmil	4/0-500 kcmil	0.85-1.45" (22-37mm)
TFT-153E-G	500-750 kcmil	500-750 kcmil	500-750 kcmil	1.06-1.70" (27-43mm)

*15kV Insulation ODs and nominal conductor sizes are based on 100 and 133% compact and concentric stranded cable dimensions. 5/8kV ODs are based on 100% compact and concentric stranded cable dimensions.

2. Prepare cables.

Choose the cable type (Choice 1-4) and follow the directions given.

Figure 1: Insulation Cutback (Z)

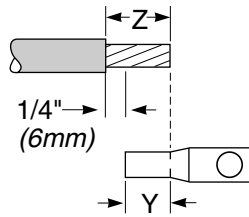

Note: If no lug is used, Z = 2" (50mm)

$$\text{"Z" Insulation Cutback} = \text{"Y" Length of Lug Barrel} + \frac{1}{4}'' (6\text{mm})$$

481

CHOICE 1

If Copper Tape Shield Cable

Refer to Figure 1 and adjacent drawing to prepare the cables as shown. Fasten copper tape shield with a small piece of copper tape foil.

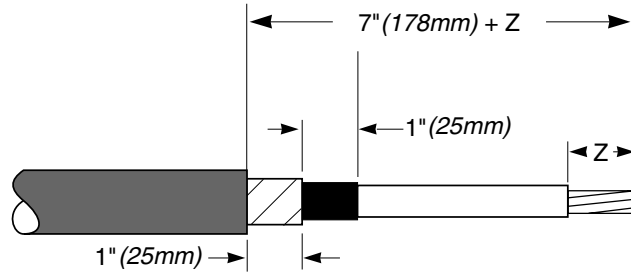

512

CHOICE 2

If Wire Shield Cable

Refer to Figure 1 and adjacent drawing to prepare the cables as shown. Pull back drain wires as shown.

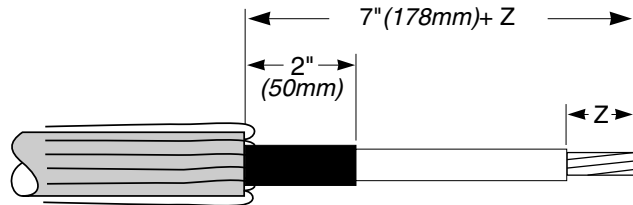

513

CHOICE 3

If UniShield Cable

Refer to Figure 1 and adjacent drawing to prepare the cables as shown. Pull back drain wires as shown before cutting jacket.

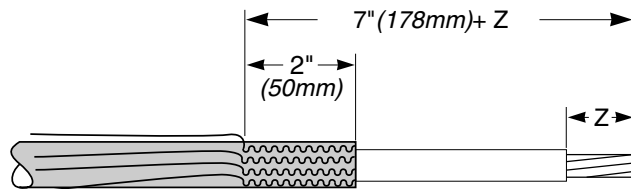

514

CHOICE 4

If Lead Sheath Cable

Refer to Figure 1 and adjacent drawing to prepare the cables as shown.

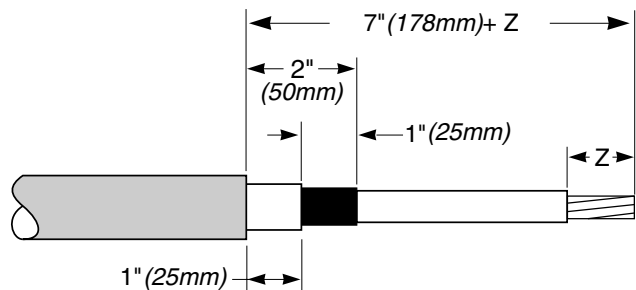

512a

3. Install ground braid.

For Copper Tape Shield Cables

(1) Flare the moisture blocked end of the ground braid and place it onto the metallic tape butted up to the cable jacket. (2) Attach the braid to the shield by placing two wraps of the spring clamp over the braid. (3) Fold the braid back over the spring clamp wraps. Continue to wrap the remaining clamp over the braid. Tighten clamp by twisting it in the direction it is wrapped and secure with the copper foil tape provided.

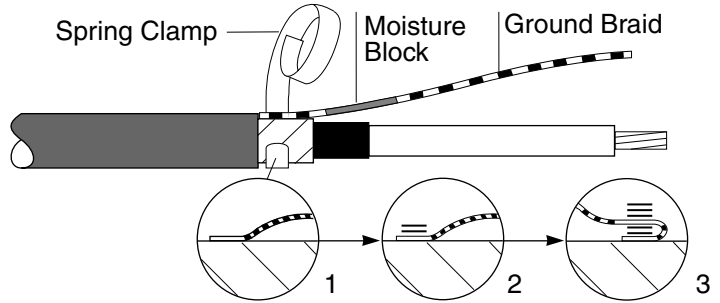

516

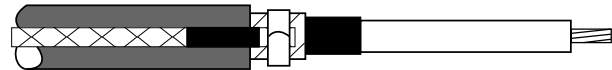

516a

For Lead Sheath cables

(1) Butt the end of the braid up against the cable jacket as shown and solder to the lead sheath.

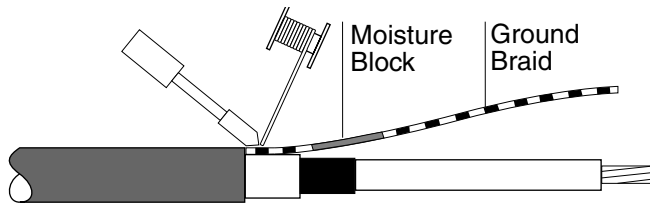

519y

Bend the braid back over the cable.



519ya

4. Make Lug Connection (for all cable types)

Crimp the connector using proper die and tool. Clean lug barrel of inhibitor and dirt and file off any sharp edges.

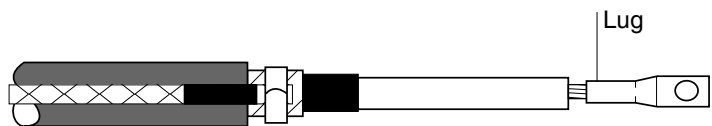

518

5. Abrade and clean insulation (for all cable types).

Abrade and clean the surface of the primary insulation using an approved solvent. Be sure to remove any conductive particles or contamination.

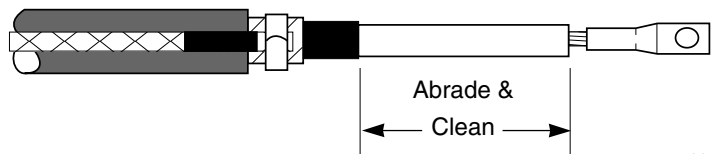

518a

6. Install sealant.

For all cable types

Build up the lug barrel diameter to that of cable insulation using tape sealant, then overlap tape sealant 1/2" (10mm) onto insulation to provide a smooth profile.

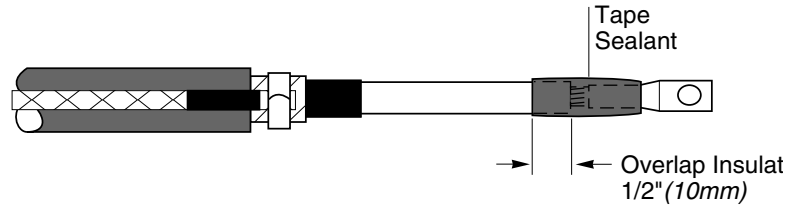

518c

For Copper Tape Shield and Lead Sheath Cables

Solvent clean and abrade jacket. Using light tension, wrap one layer of sealant onto the cable jacket as shown.

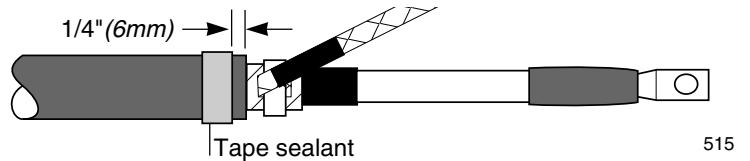

515

Press the solder-blocked portion of the braid into the sealant. Wrap an additional layer of sealant over the braid solder block.

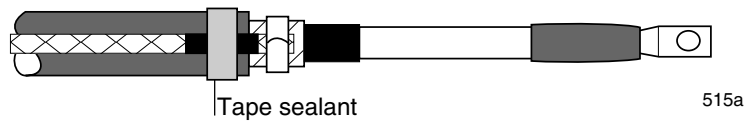

515a

For Wire Shield or Unshield cables

Lift the drain wires away from the cable jacket. Solvent clean and abrade jacket. Using light tension, wrap one layer of sealant onto the cable jacket as shown.

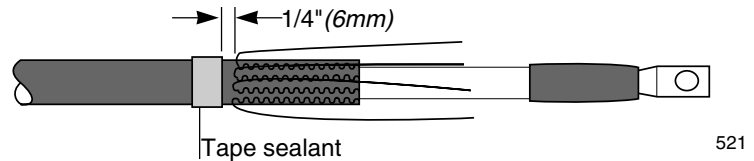

521

Lay the drain wires evenly back over the jacket and press them into the sealant.

Wrap an additional layer of sealant over the drain wires and previously applied sealant.

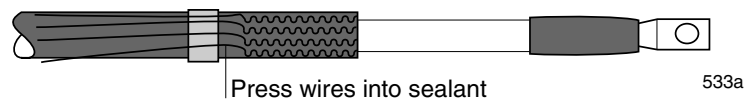

533a

7. Apply Stress Patch (for all cable types).

Note: The stress patch easily sticks to itself and loose particles.

Remove backing paper from the patch. Using light tension and overlapping the semicon by 1" (25mm), wrap the entire patch around the semi-con as shown. Avoid wrinkles and creases.

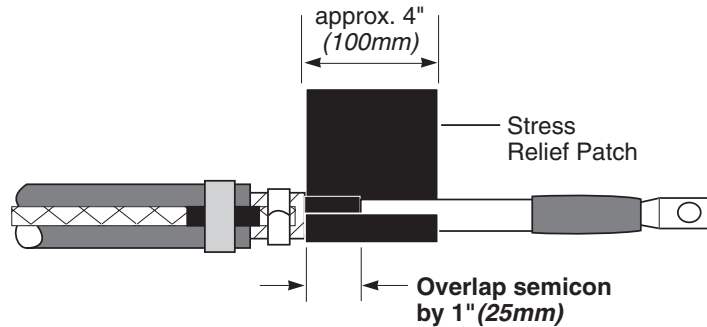

519

8. Tape over sharp edges (Copper Tape and Lead Sheath cables only)

Using cloth tape provided, tape over all sharp edges of the ground clamp assembly.

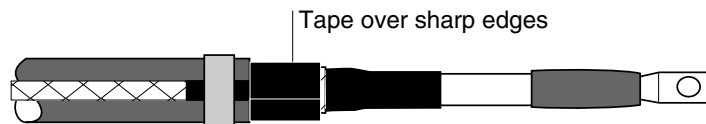

519a

9. Loosening Termination

This operation is vital to the simple installation of the product.

Hold the termination in one hand and the holdout in the other. Gripping firmly, twist the termination and holdout in opposite directions. Repeat twisting the termination and holdout, moving the hand in short increments up the termination until the entire termination is felt to move on the holdout.

Take care not to slide the termination off the end of the holdout.

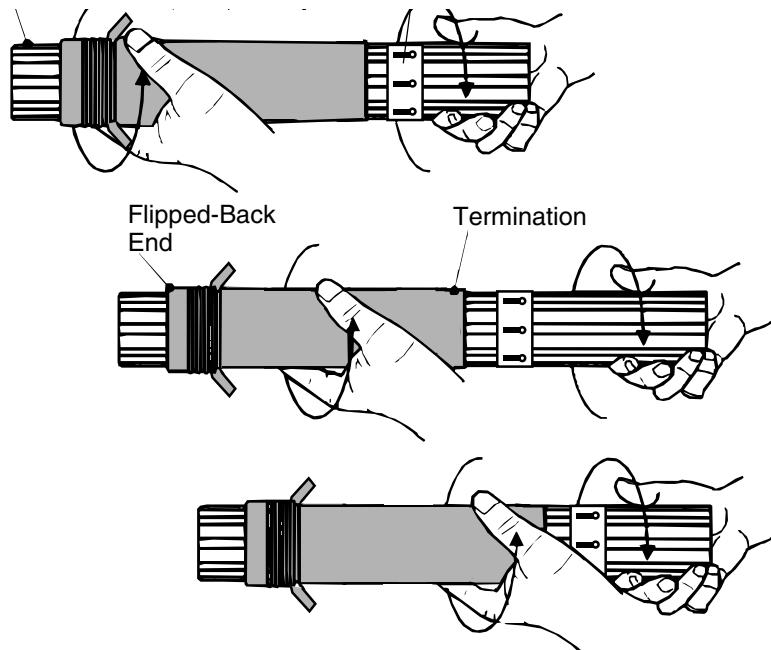

523ca

Installation Instructions

10. Installing termination.

Position the holdout over the cable until it meets the jacket cutback. Twist the termination and slowly push it to the end of the holdout.

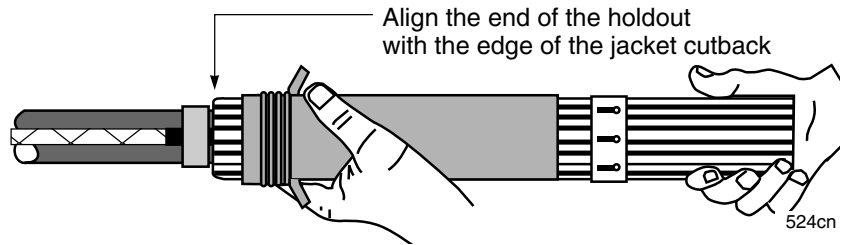

Slide the termination completely off the holdout using a twisting and pulling motion as shown.

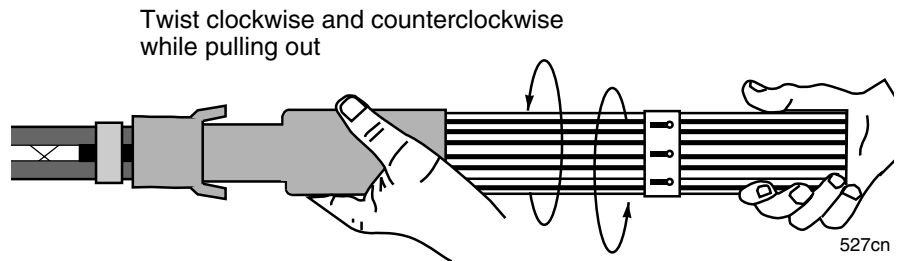

Using the pull tabs, pull the flip-back portion away from the main termination, at the same time working the first two fingers of each hand between the flip back and main termination. Pull the stretched out flip back over the cable jacket and sealant.

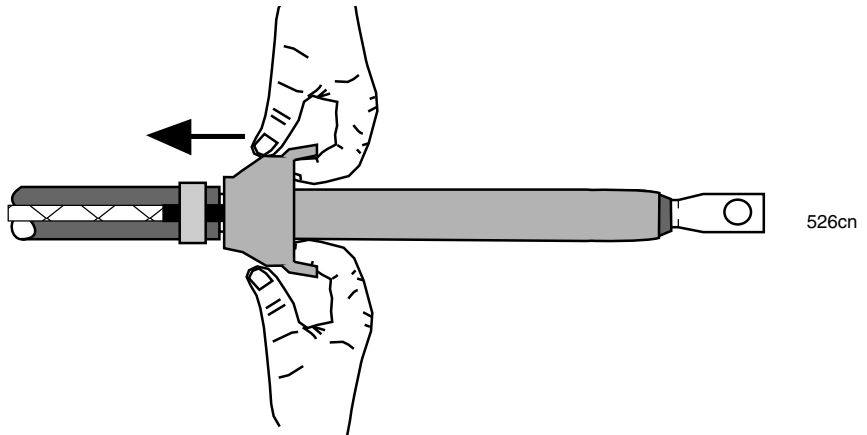

If after installation the termination is not correctly positioned, it is possible to gently slide it into place, so that the final assembly is positioned as shown in the drawing in step 11.

11. Complete termination.

Wipe over the surface of the termination to remove any dirt or grease.

Note: Be sure to position termination at lug end so that there is a bead of sealant exposed as shown.

This completes the installation.

