

PROPER USE GUIDELINES

Cumulative Trauma Disorders can result from the prolonged use of manually powered hand tools. Hand tools are intended for occasional use and low volume applications. A wide selection of powered application equipment for extended-use, production operations is available.

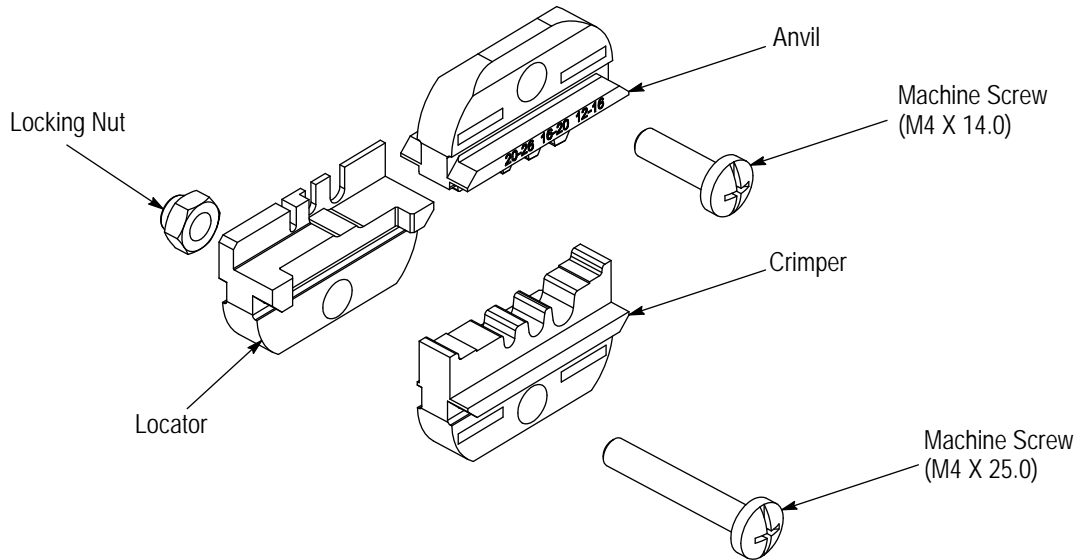

TE Connectivity Die Set	Raychem MiniSeal Contact Part Numbers						Wire					
							Wire Color	Wire Size Range (AWG)	Max No. of Wires Per Side	Crimp Barrel Size Range (Min-Max)		Wire Strip Length
										CMA	mm ² [in.]	
SDE Die Set 1752939-1	D-436-36	D-436-82	D-609-03	D-609-06	D-609-09	D-609-12	Red	20-26	2	304-1510	0.15-0.75 [0.06-.030]	7.9-8.6 [31-.34]
	D-436-37	D-436-83	D-609-04	D-609-07	D-609-10	D-609-13	Blue	16-20	2	779-2680	0.39-1.34 [0.15-.053]	7.9-8.6 [31-.34]
	D-436-38	D-436-84	D-609-05	D-609-08	D-609-11	D-609-14	Yellow	12-16	2	1900-6755	0.95-3.37 [0.37-1.33]	7.9-8.6 [31-.34]

Figure 1

1. INTRODUCTION

This instruction sheet provides information for SDE Die Set 1752939-1 which is designed to crimp Raychem MiniSeal Splices. This die assembly will fit into the tools shown in Figure 4.

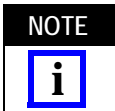

Dimensions in this instruction sheet are in millimeters [with inches in brackets]. Figures and illustrations are for reference only, and are not drawn to scale.

Refer to Section 8, REVISION SUMMARY for reasons for revision.

2. DESCRIPTION

This die set has three crimp sections which are marked to identify the wire sizes used with the products listed in the table in Figure 1. The AWG wire sizes are 20-26, 16-20, and 12-16.

3. DIE INSTALLATION

Refer to the specific tooling documents provided in Figure 4 for die installation information for those tools. Since each application tool is unique, each tool will have their own specific instructions for die installation.

4. CRIMPING PROCEDURE

While referring to the specific tooling instruction material for die installation and crimping procedures, the following information should be observed:

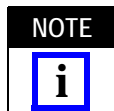

For proper crimp location, make sure to position the splice in the die nest according to the instruction sheet provided with the crimp tooling.



Damaged splices should not be used. If a damaged splice is evident, it should be removed and replaced with a new one. Splices should not be reterminated.

Strip the wire according to the dimensions listed in Figure 1. The strip length is determined by the splice and by the wire size. Do not nick or cut the wire strands. Proceed as follows:

1. Close the tool handles until the ratchet releases. Allow the tool handles to open fully.
2. Place the splice against the locator in the appropriate crimp chamber. See Figure 2.

Step 1

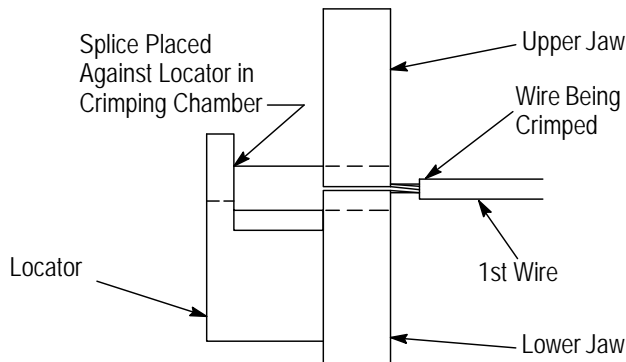

Step 2

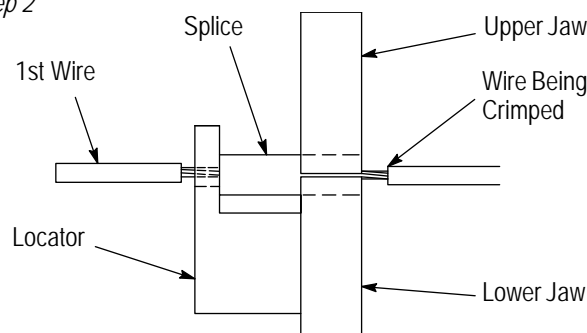

NOTE: If the wire is stripped correctly (Figure 1), the conductor will be exposed slightly more than the thickness of the locator. This will allow the conductor to enter the slot in the locator.

Figure 2

3. While holding the splice in place, squeeze the tool handles together just until the jaws begin to close on the wire barrel. Do NOT deform the wire barrel.
4. Insert the stripped wire into the wire barrel, making sure that the wire insulation does not enter the wire barrel.
5. While holding the wire in place, squeeze the tool handles together until the ratchet releases, then allow the tool handles to open fully.
6. To crimp the other half of a butt splice, position the crimped wire barrel against the locator. The crimped wire will go through the slot in the locator. The uncrimped barrel will line up with the crimping chamber. Repeat the crimping procedure.

5. DIE INSPECTION

5.1. Visual Inspection

Inspection of the crimping dies should be made on a regular basis to ensure that they have not become worn or damaged. Inspect the crimp sections for flattened, chipped, worn, or broken areas. If damage or abnormal wear is evident, the dies must be replaced.

5.2. Measured Die Opening

The dies will perform properly as long as: (1) the product specified is correct for the application, (2) the specified die set is used, (3) the die set has been measured to ensure that the openings are correct, and (4) the dies bottoms.

6. CRIMP HEIGHT INSPECTION

This inspection requires the use of plug gages conforming to the dimensions provided in Figure 3. TE does not manufacture or market these gages. To gage the crimping chamber, proceed as follows:

1. Remove traces of oil or dirt from the crimping chamber and plug gage.
2. Close the tool handles, or cycle the crimp tooling until the dies have bottomed. Do NOT force dies beyond initial contact.
3. Align the GO element with the crimping chamber. Push element straight into the crimping chamber without using force.
4. Align the NO-GO element and try to insert it straight into the same crimping chamber. The NO-GO element may start entry, but must not pass completely through the crimping chamber. See Figure 3.

If the crimping chamber conforms to the gage inspection, the dies are considered dimensionally correct, and should be lubricated with a THIN coat of any good SAE 20 motor oil. If not, the dies must be returned to TE for further evaluation. Refer to Section 7, REPAIR/REPLACEMENT.

For additional information regarding the use of a plug gage, refer to TE Instruction Sheet 408-7424.

7. REPAIR/REPLACEMENT

If the crimp cannot be made to conform to the dimensions provided in the table in Figure 1, the tool and/or dies are defective and must be replaced.

Order replacements through your TE Representative, or call 1-800-526-5142, or send a facsimile of your purchase order to 717-986-7605, or write to:

CUSTOMER SERVICE (038-035)
 TYCO ELECTRONICS CORPORATION
 PO BOX 3608
 HARRISBURG PA 17105-3608

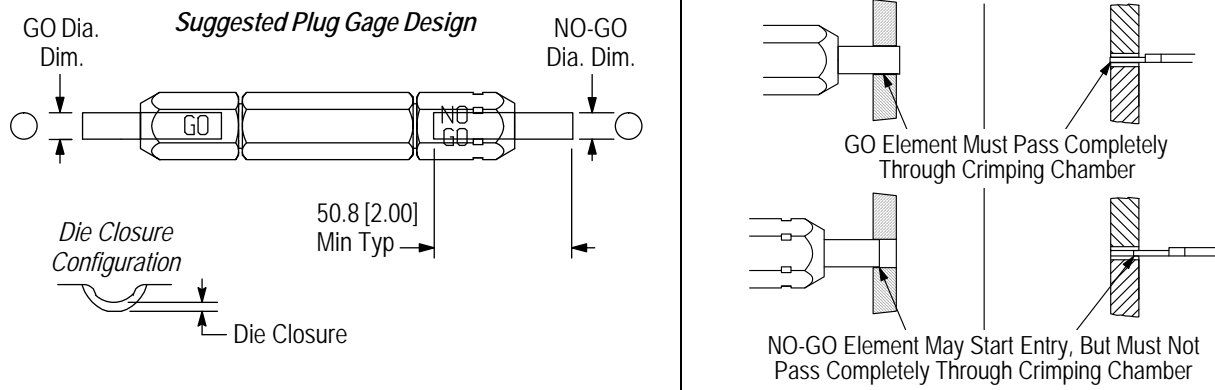

SDE Die Set 1752939-1 for Raychem MiniSeal Splices

Cavity	Die Closure		Gage Elements	
	GO	NO-GO	GO	NO-GO
20-26	0.64 [.025]	0.81 [.032]	0.635-0.643 [.0250-.0253]	0.836-0.838 [.0329-.0330]
16-20	1.07 [.042]	1.24 [.049]	1.067-1.074 [.0420-.0423]	1.267-1.27 [.0499-.0500]
12-16	1.57 [.062]	1.75 [.069]	1.575-1.582 [.0620-.0623]	1.775-1.778 [.0699-.0700]

Figure 3

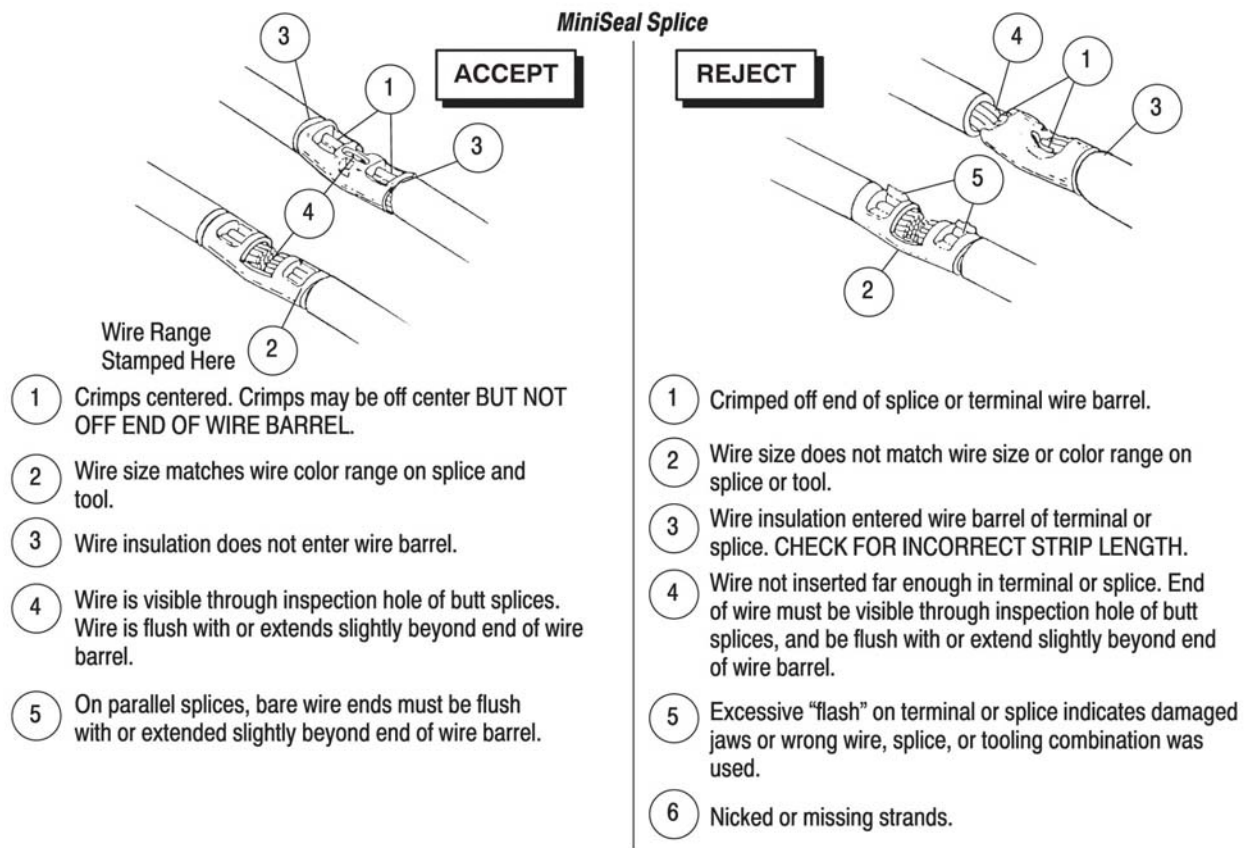

Figure 4

8. REVISION SUMMARY

- Added new Figure 4 and renumbered

Tooling Compatible with Die Assembly 1752939-1

PRO-CRIMPER* III Hand Tool Frame 354940-1
(Instruction Sheet 408-9930)

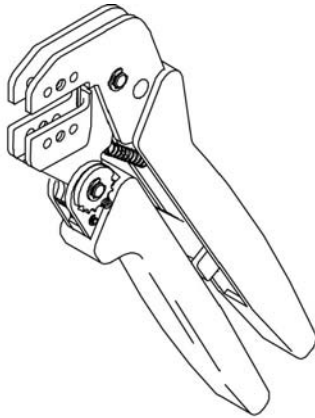

SDE-SA Hand Tool 9-1478240-0
(Instruction Sheet 408-8851)

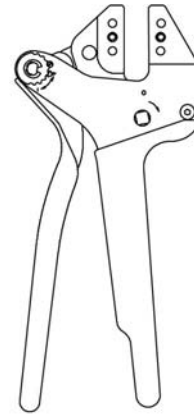

SDE Bench Terminator 1490076-2
(Customer Manual 409-10052)

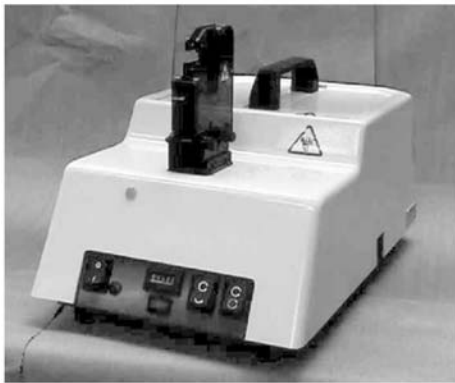

626 Adapter 679304-1
(Instruction Sheet 408-4070)

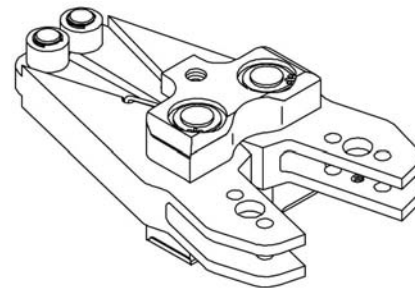

**Electro-Hydraulic (BT 3500 Battery-Hydraulic)
Hand Tool Kits 2031400-[]**
(Customer Manual 409-10095)

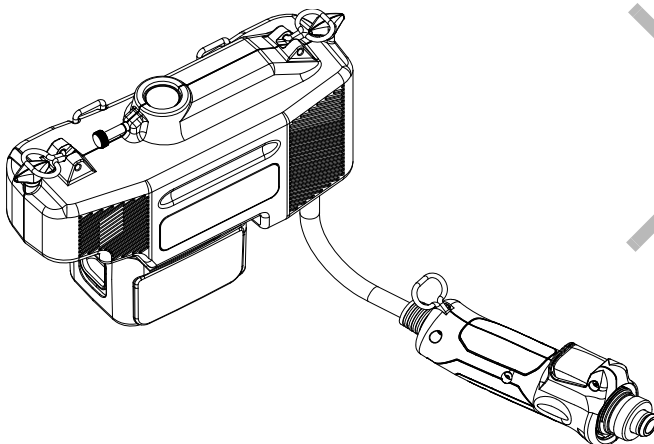

Closed Head Assembly 2031460-1
(Instruction Sheet 408-10312)

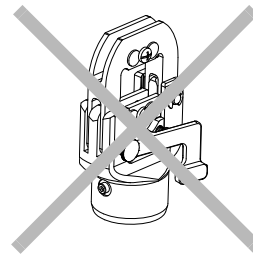

"C"-Head Assembly 2031450-1
(Instruction Sheet 408-10311)

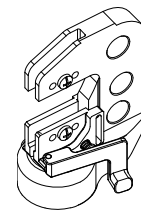

Figure 5