

THIS DRAWING IS UNPUBLISHED. RELEASED FOR PUBLICATION 2011
 © COPYRIGHT 2011 ALL RIGHTS RESERVED.

LOC	DIST	REVISIONS					
AL	2	P	LTR	DESCRIPTION	DATE	DWN	APVD
		E1		ECR 12-004643	17APR2012	XP	RS
		E2		TOLERANCE FROM DIM 40.1 CHANGED	23MAR2015	Ho.	Krauss
		E3		OBSOLETE VARIANT 365066-1	06OCT2023	KMD	SCK

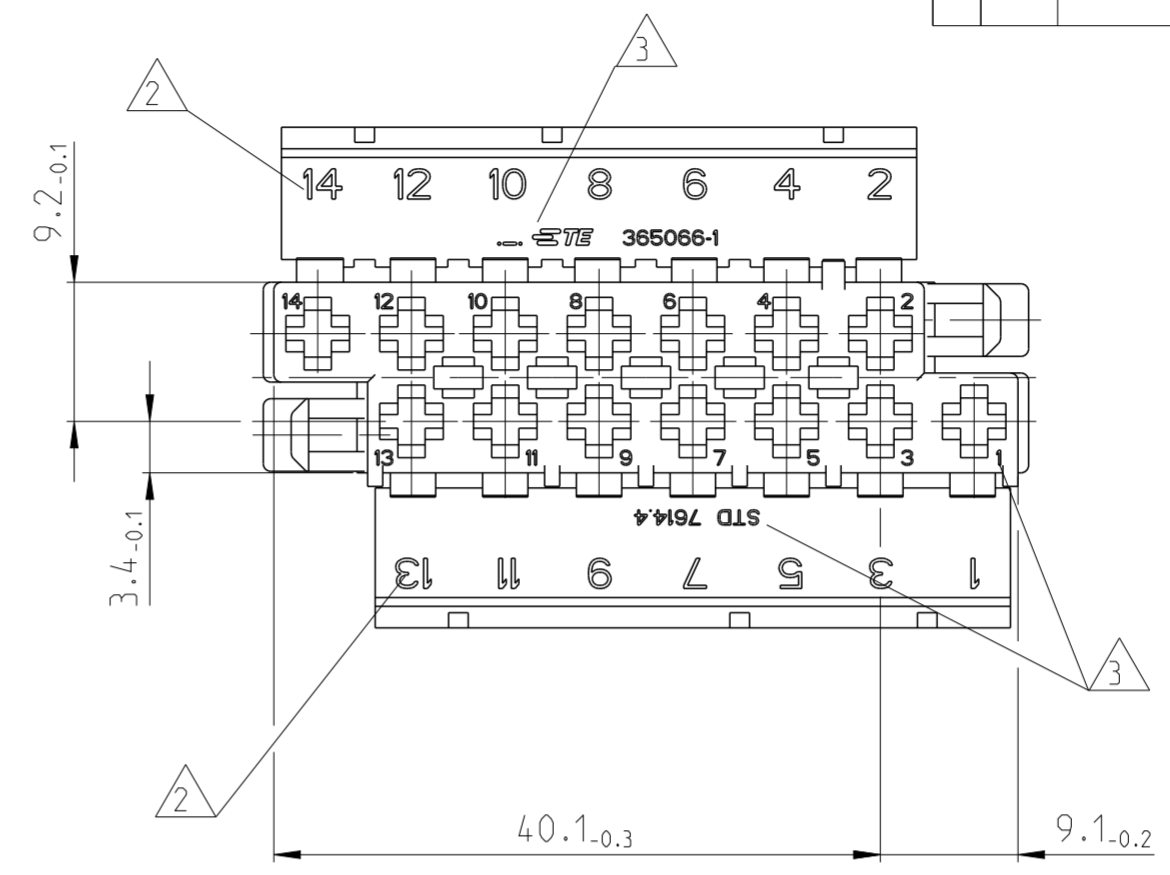

SECCION B-B SECTION

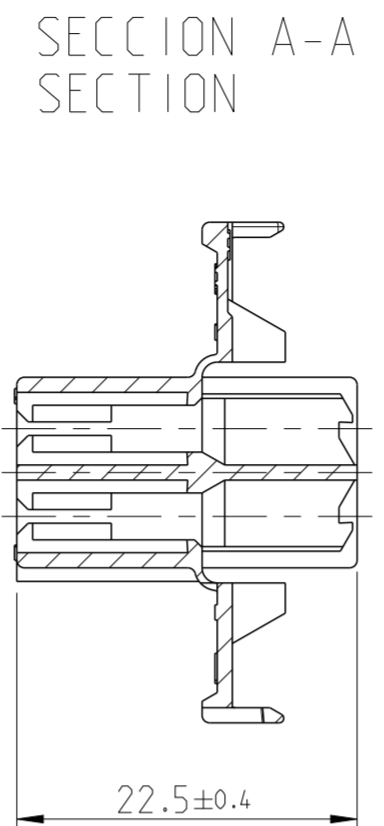
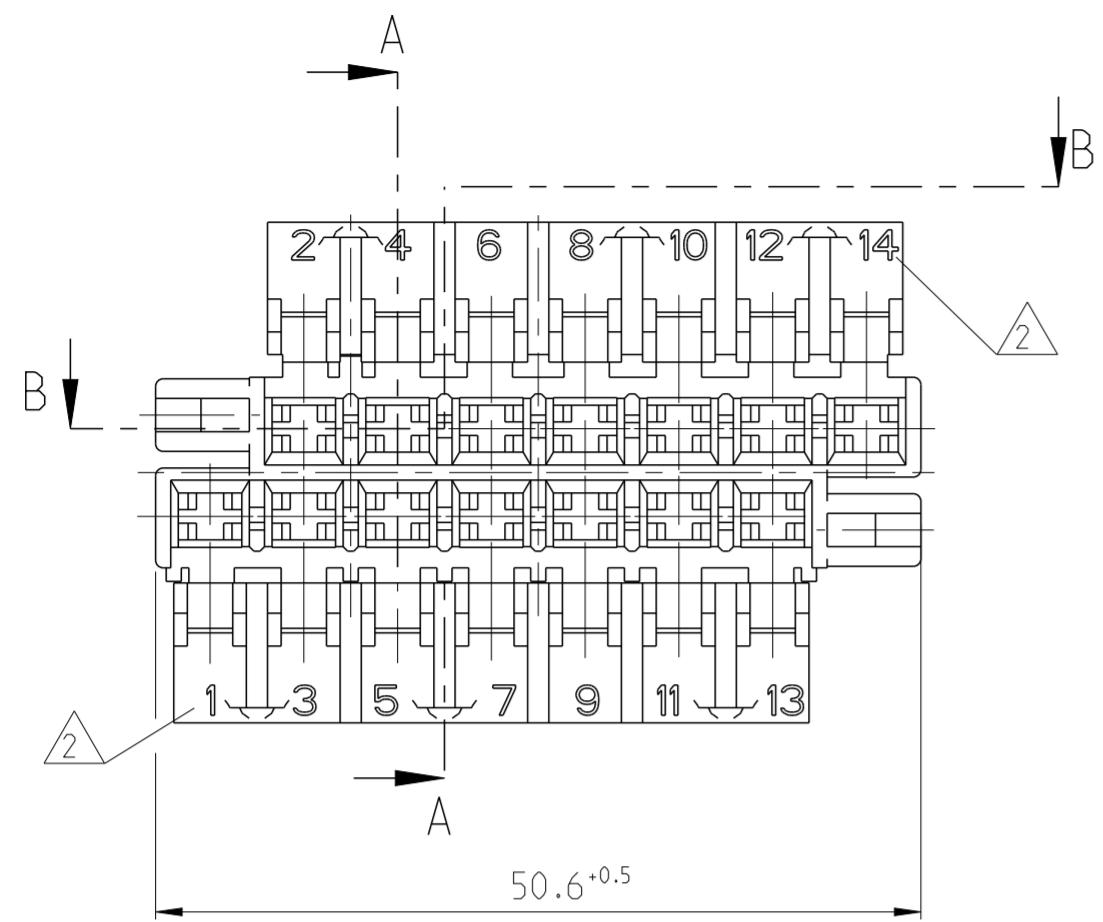
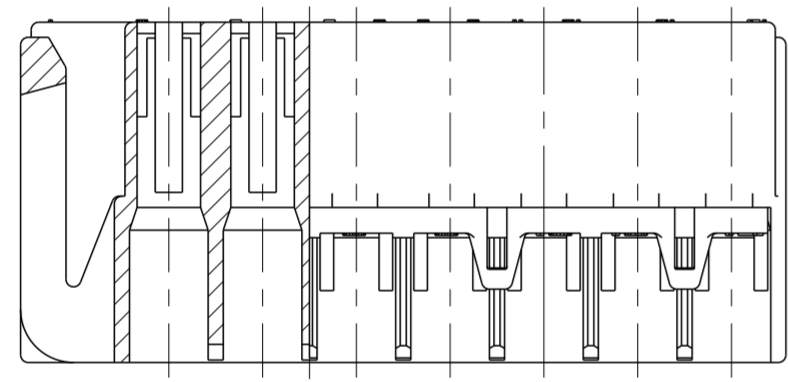

DETALLE CAJA CON BISAGRA CERRADA HOUSING WITH CLOSED FLAP

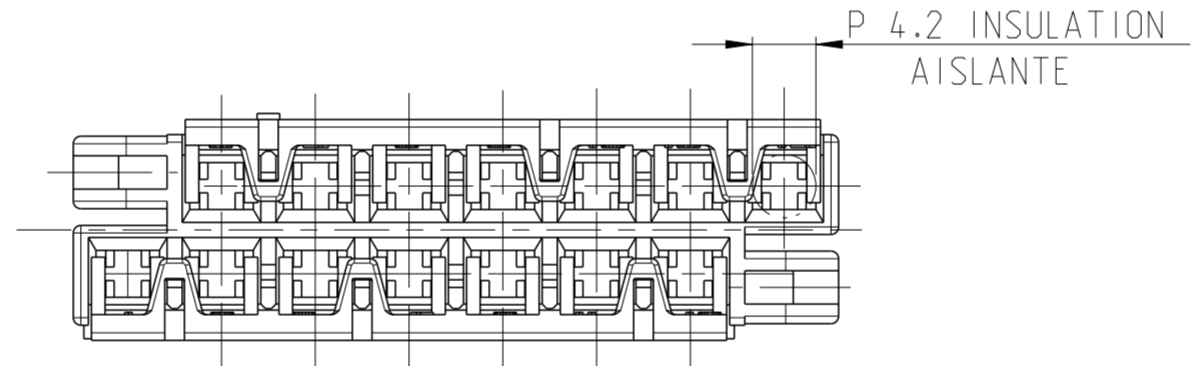

- 1 MATERIAL Y COLORES HAN DE ESTAR LIBRES DE CADMIO
MATERIAL AND COLORS ARE FREE OF CADMIUM
- 2 ALTURA LETRA 2
CHARACTER HEIGHT 2
- 3 ALTURA LETRA 1
CHARACTER HEIGHT 1
- 4 USAR CON 365065
FITTING WITH 365065
- 5 LAS PIEZAS DEBEN IR EMPAQUETADAS HERMETICAMENTE
Y SU CONTENIDO DE HUMEDAD DEBE SER 2.5±1%
PARTS MUST BE AIR TIGHT PACKAGED,
MOISTURE CONTENT MUST BE 2.5±1%

CODIGO 1 CODING 1 ESCALA 1:1 SCALE
 CODIGO 2 CODING 2 ESCALA 1:1 SCALE
 CODIGO 3 CODING 3 ESCALA 1:1 SCALE
 CODIGO 4 CODING 4 ESCALA 1:1 SCALE

CODE NO.	PART NO.	MATERIAL	COLOUR
CODE 4	365066-4	PA 6.6	YELLOW
CODE 3	365066-3	PA 6.6	BLACK
CODE 2	365066-2	PA 6.6	GREY
OBSOLETE CODE 1	365066-1	PA 6.6	NATUR

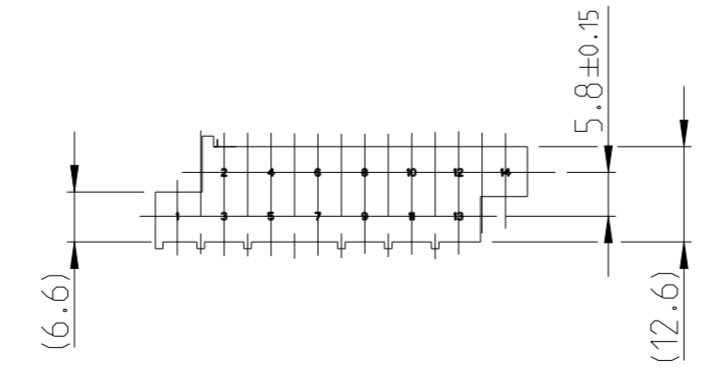
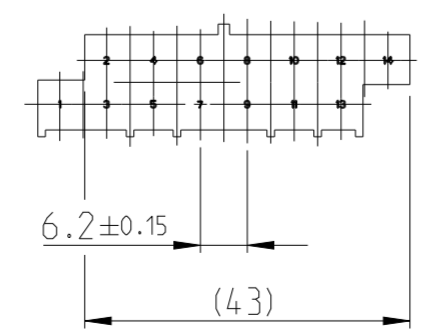
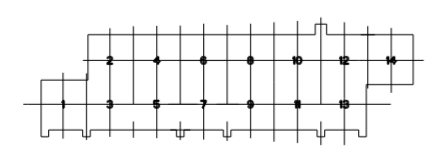
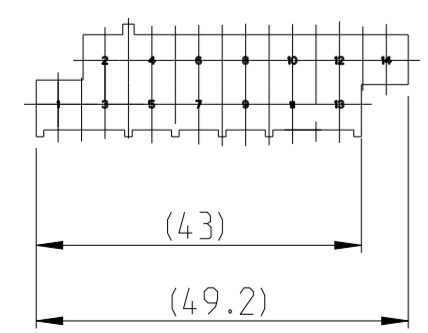

THIS DRAWING IS A CONTROLLED DOCUMENT.

DIMENSIONS: mm	TOLERANCES UNLESS OTHERWISE SPECIFIED:	DWN R. ULLRICH 18OCT1984	TE Connectivity
	0 PLC ±	CHK J. PASCUAL 15JUN1993	
	1 PLC ±	APVD L. BATILLO 15JUN1993	
	2 PLC ± ±0.2	NAME	
MATERIAL SEE PART LIST	4 PLC ±	PRODUCT SPEC	14 POS. HOUSING FOR JUNIOR TIMER CONTACT
	ANGLES ±°	APPLICATION SPEC	SIZE A2
	FINISH	WEIGHT -	CAGE CODE 00779
		Customer Drawing	DRAWING NO. C-365066
			RESTRICTED TO -
			SCALE 2:1 SHEET 1 OF 1 REV E3